

OWNERS MANUAL



POWER ACOUSTIK

OVN4-840 / OVN4-1200 / OVN4-1600
OVN1-1800D / OVN1-3000D / OVN1-4000D / OVN1-5500D
OVN2-600 / OVN2-800
OVN2-1250 / OVN2-1800 / OVN2-2200



INTRODUCTION

Power Acoustik amplifiers provide high-performance sound reinforcement for your mobile audio equipment. Its versatility enables compatibility with optional Equalizers, Frequency Dividing Crossover Networks, and other audio processors in a customized system. The Multi-Mode bridging capabilities allow flexibility in hosting several different speaker configurations.

To achieve optimum performance, it is highly recommended that you read this Owners Manual before beginning installation.

WARNING

High powered audio systems in a vehicle are capable of generating "Live Concert" high levels of sound pressure. Continued exposure to excessively high volume sound levels may cause hearing loss or damage. Also, operation of a motor vehicle while listening to audio equipment at high volume levels may impair your ability to hear external sounds such as; horns, warning signals, or emergency vehicles, thus contributing to a potential traffic hazard. In the interest of safety, Power Acoustik recommends listening at lower volume levels while driving.

CONNECTING THE POWER (Fig.1)

CAUTION:

AS A PRECAUTION, DISCONNECT THE POWER WIRE FROM THE BATTERY WHILE MAKING THE POWER AND GROUND CONNECTIONS TO THE AMPLIFIER.

4/8 GAUGE (Thicker if planning for additional Amplifiers) wire is recommended for both the power and ground wires. 12 Gauge, for the remote turn-on wire. Both types are available at most Mobile Audio Dealers or Installation Shop.

(1) Ground : *To Vehicle Chassis*

To avoid unwanted ignition noise caused by ground loop, it is essential that the Amplifier be grounded to a clean, bare, metal surface of the vehicle's *Chassis*

NOTE :

GROUND WIRE SHOULD NOT BE EXTENDED MORE THAN 3 FT. (1 METER).

(2) +12 Volt (Fused) Constant Power: *To Battery (+)*

Due to the power requirements of the Amplifier, this connection should be made directly to the positive (+) terminal of battery. For safety measures, install an in-line Fuse Holder (not included) as close to the battery positive (+) terminal as possible with an ampere rating; not to exceed total value of fuses in Amp.

(3) Remote Turn-On Input: *To remote turn-on output of Car Stereo*

This Amplifier is turned "ON" remotely when the vehicle's stereo is turned "ON".

NOTE :

IF YOUR RADIO DOES NOT HAVE A +12 VOLT OUTPUT LEAD WHEN THE RADIO IS TURNED ON, THE "REMOTE" TERMINAL ON THE AMPLIFIER CAN BE CONNECTED TO VEHICLE'S ACCESSORY CIRCUIT THAT IS LIVE WHEN THE KEY IS "ON".

FIG. 1

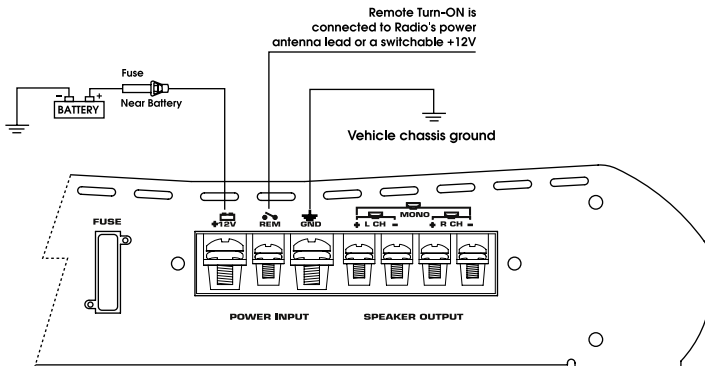

CONTROLS

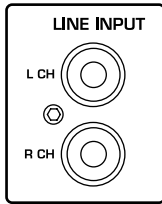

RCA input jacks

These RCA input jacks are for use with source units that have RCA or Line level outputs. A source unit with a minimum level of 200mV is required for proper operation. The use of high quality twisted pair cables is recommended to decrease the possibility of radiated noise entering the system.

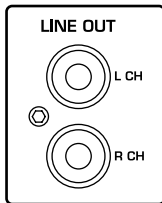

Auxiliary outputs

The Auxiliary outputs offer Power Acoustik amplifiers easy, unlimited system expansion. Route RCA's from the line out of the first amplifier to the line input of a second amplifier when using a single source output.

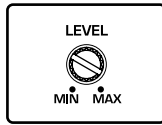

LEVEL Control

The level control will match the amplifiers sensitivity to the source units signal voltage.

OVN2-600/OVN4-840/OVN4-1200/OVN4-1600

OVN1-1800D/OVN1-3000D/OVN1-4000D/OVN1-5500D : The Operating range is 200mV minimum to 6V maximum.

OVN2-800/OVN2-1250/1800/2200 : The Operating range is 200mV minimum to 3V maximum.

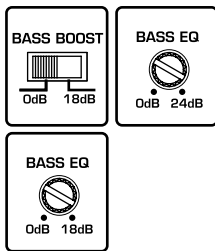

CAUTION: Do not run the amplifier in high volume for long time, otherwise the loudspeakers will be damaged.

Bass EQ / BASS BOOST

OVN2-600/OVN4-840/OVN4-1200/OVN4-1600 : The boost can be selected 0dB or 18dB.

OVN2-800/OVN2-1250/OVN2-1800/OVN2-2200 : The boost can be adjusted between 0dB to 24dB.

OVN1-1800D/OVN1-3000D/OVN1-4000D/OVN1-5500D : The boost can be adjusted between 0dB to 18dB.

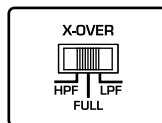

Full pass x-over switch

When the switch is in the "Full" position, full range signal is passed.

HPF X-over switch

When the switch is in the "HPF" position, frequencies higher than the high pass frequency setting are passed.

LPF X-over switch

When the switch is in the "LPF" position, frequencies lower than the low pass frequency setting are passed.

CONTROLS

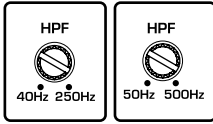

High pass x-over frequency control

This control is used to select the desired high pass x-over frequency.

OVN2-600/OVN4-840/OVN4-1200/OVN4-1600 : The frequency can be adjusted between 40Hz and 250Hz.

OVN2-800/OVN2-1250/OVN2-1800/OVN2-2200 : The frequency can be adjusted between 50Hz and 500Hz.

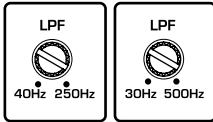

Low pass x-over frequency control

This control is used to select the desired low pass x-over frequency.

OVN2-600/OVN4-840/OVN4-1200/OVN4-1600 : The frequency can be adjusted between 40Hz and 250Hz.

OVN2-800/OVN2-1250/OVN2-1800/OVN2-2200 : The frequency can be adjusted between 30Hz and 500Hz.

OVN1-1800D/OVN1-3000D/OVN1-4000D/OVN1-5500D : The frequency can be adjusted between 40Hz and 200Hz.

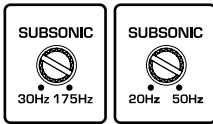

SUBSONIC

OVN2-800/OVN2-1250/OVN2-1800/OVN2-2200 : The frequency can be adjusted between 30Hz and 175Hz.

OVN1-1800D/OVN1-3000D/OVN1-4000D/OVN1-5500D : The frequency can be adjusted between 20Hz and 50Hz.

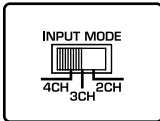

INPUT MODE

Selects 2, 3 or 4 channel operation(FIG. 2)

FIG. 2

OVN4-840/1200/1600

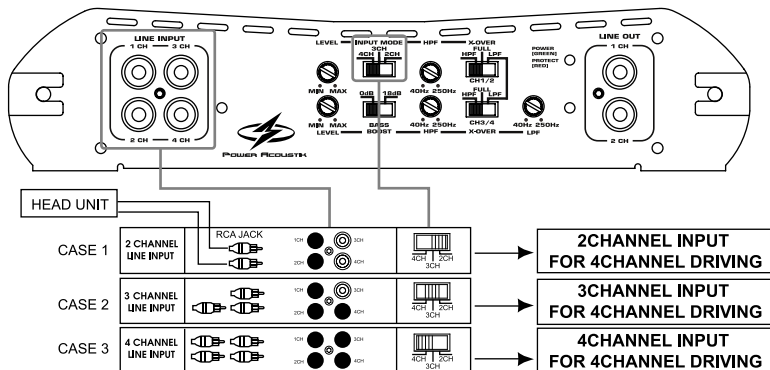

CONTROLS

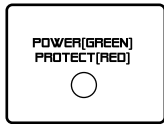

LED

Will illuminate GREEN to indicate the amplifier is on and operating normally, and will be illuminated RED if the amplifier shuts down due to short circuit, DC offset, or overheating detected by on board protection circuitry.

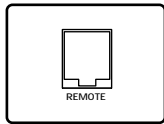

REMOTE

Controls the subwoofer amplifier gain, from a remote location for ease of adjustment during listening.

Warning: Do not connect a level control knob from other manufacturers to the Remote Sub Level Control of any amplifier. Even though the connectors fit properly, the control knob and connector pin positions may be different and the amplifier will be damaged.

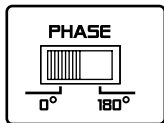

PHASE

0° or 180° selectable for switching the phase of the output to the woofer.

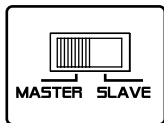

MASTER/SLAVE MODE [OVN1-1800D/3000D/4000D/5500D]

Controls whether the amplifier is a slave or master when connected in combined amplifier configurations. (Refer to the Master Mode section of this guide.)

All of the controls will be adjusted by the "Master" amplifier.

-Slave mode : To be switched " Slave mode" when linking one amplifier with another amplifier.

-Master mode : To be switched " Master mode" when only using this single amplifier.

MASTER MODE CONFIGURATION

OVN1-1800D / OVN1-3000D / OVN1-4000D / OVN1-5500D

MASTER MODE

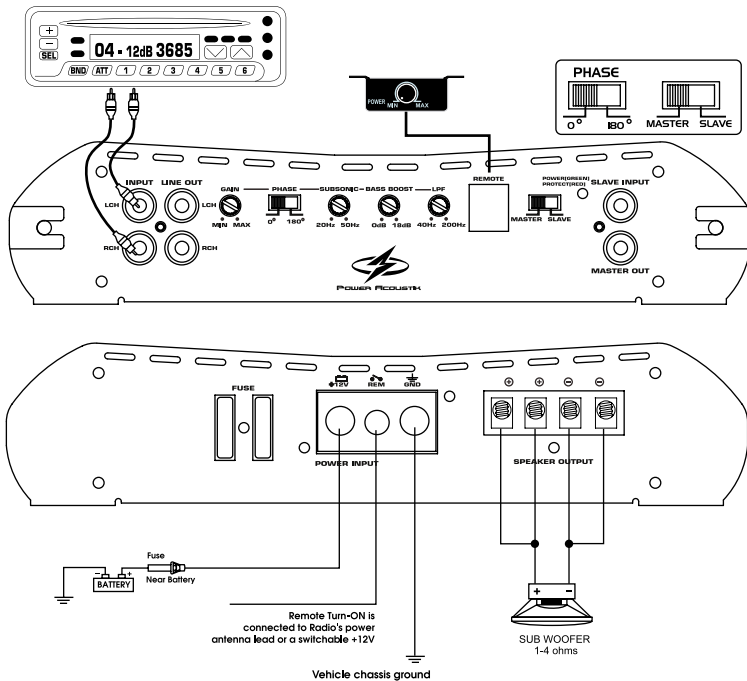

1. Lowest Recommended Impedance is 1ohm mono.
2. RCA Inputs are connected to both Left and Right channels
3. Gain controls to be set match input source
4. Line Output configured for stereo operation

STRAPPED CONFIGURATION

OVN1-1800D / 3000D / OVN1-4000D / OVN1-5500D

STRAPPED

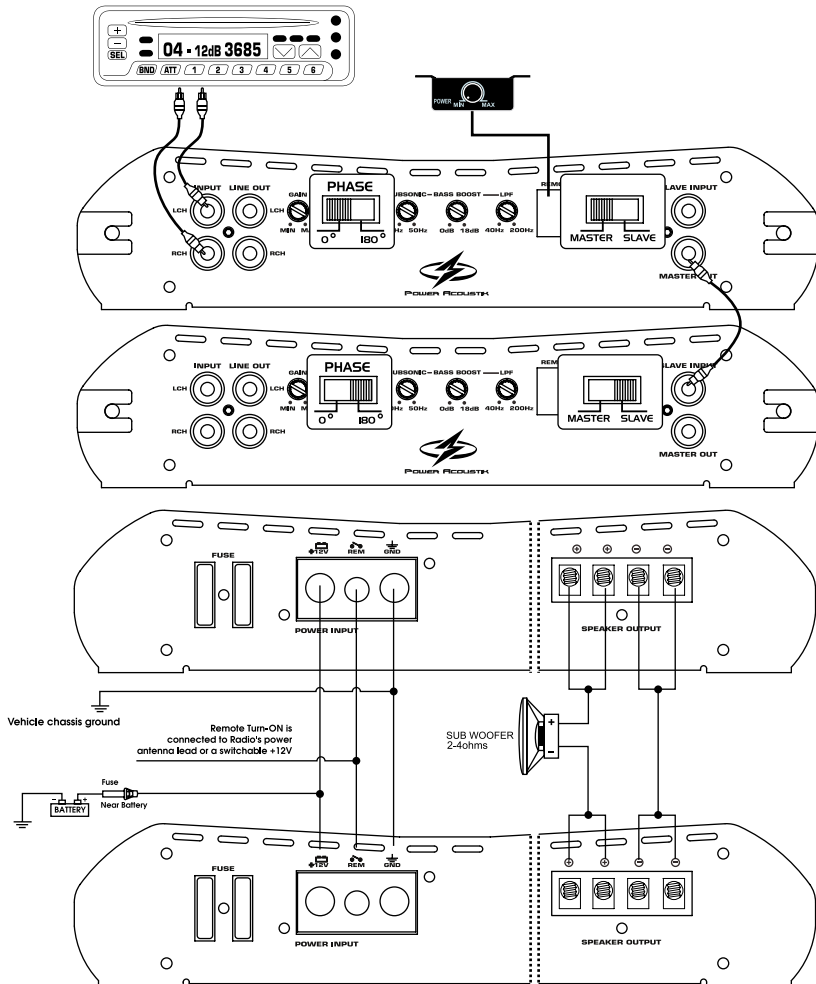

1. Lowest Recommended Impedance is 2ohm Stereo
2. RCA Inputs are connected to both Left and Right channels
3. Gain controls to be set match input source
4. Line Output is configured summed bridged which is ideal for subwoofer applications

2 CHANNEL STEREO CONFIGURATION OVN2-600/800/1250/1800/2200

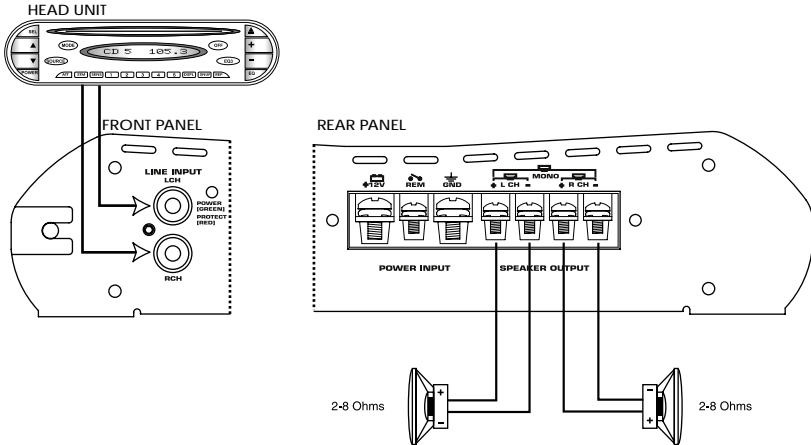

1. Lowest Recommended Impedance is 2ohm Stereo
2. RCA Inputs are connected to both Left and Right channels
3. Gain controls to be set match input source
4. Line Output configured for stereo operation

2 CHANNEL BRIDGED CONFIGURATION

OVN2-600/800/1250/1800/2200

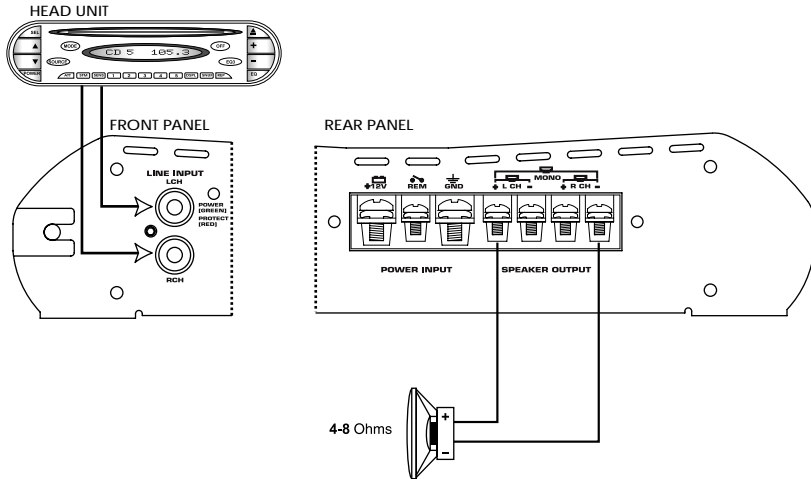

1. Lowest recommended impedance is 4ohm bridged mono
2. RCA Inputs are connected to both Left & Right channels
3. Line Output configured for stereo operation

2 CHANNEL TRI MODE CONFIGURATION

OVN2-600 / OVN2-800 / OVN2-1250 / OVN2-1800 / OVN2-2200

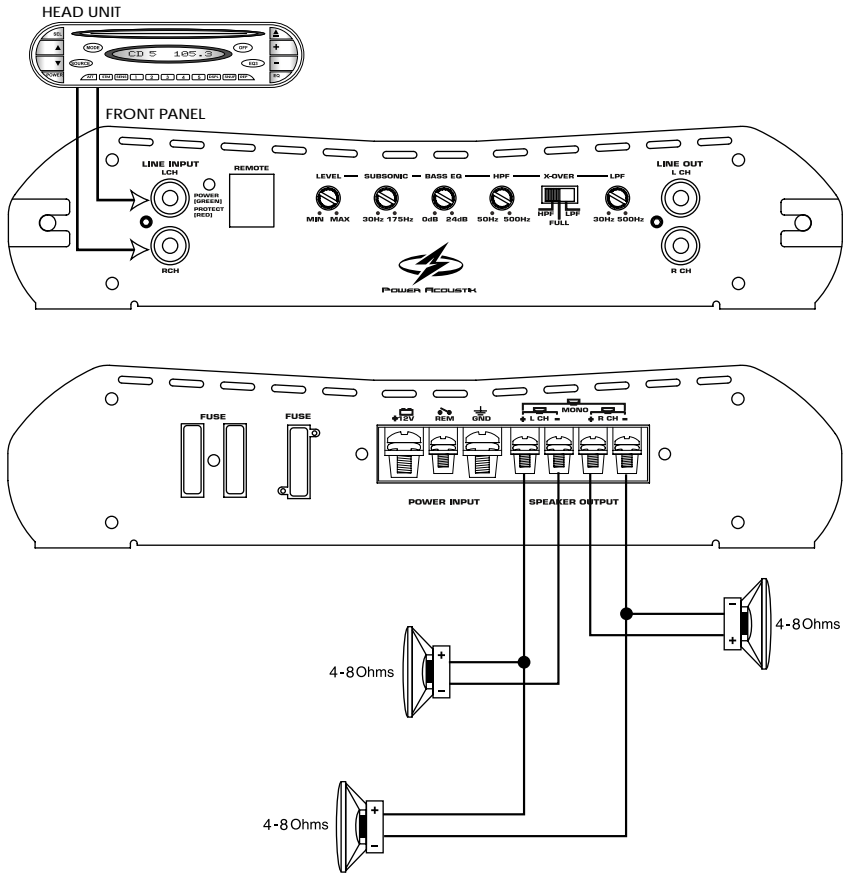

- 1.Lowest Recommended Impedance is 4ohm Stereo
- 2.RCA Inputs are connected to both Left and Right channels
- 3.Output configured for stereo operation

4 CHANNEL STEREO CONFIGURATION

OVN4-840 / OVN4-1200 / OVN4-1600

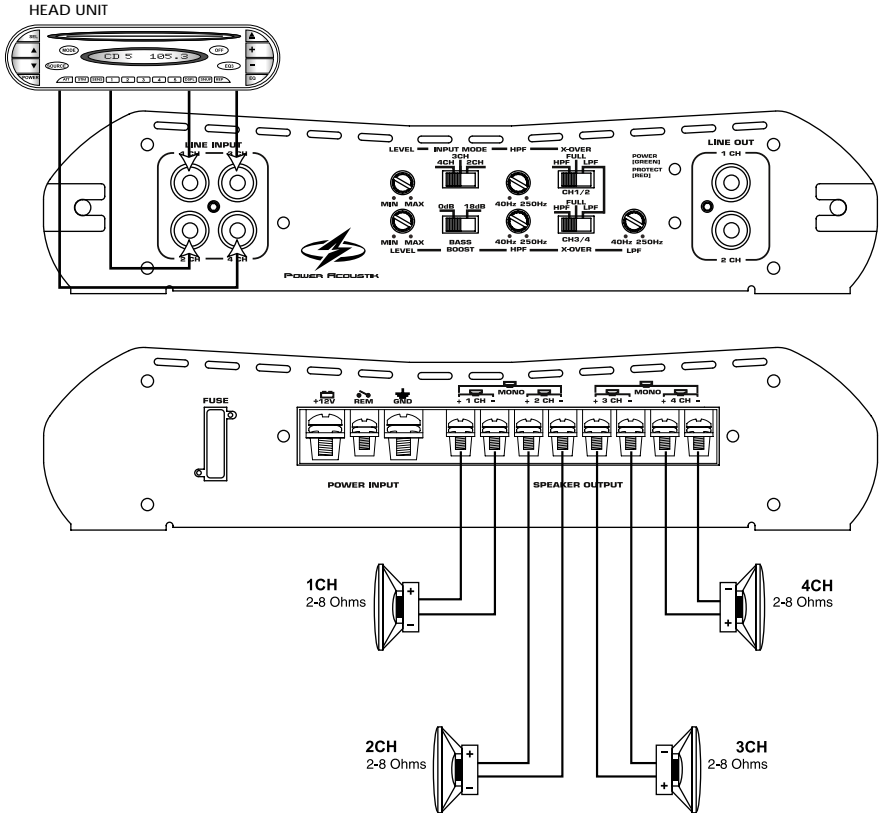

- 1.Lowest Recommended Impedance is 2ohm Stereo
- 2.RCA Inputs are connected to both Left and Right channels
- 3.Gain controls to be set match input source
- 4.Line Output configured for stereo operation

4 CHANNEL TRI MODE CONFIGURATION

OVN4-840 / OVN4-1200 / OVN4-1600

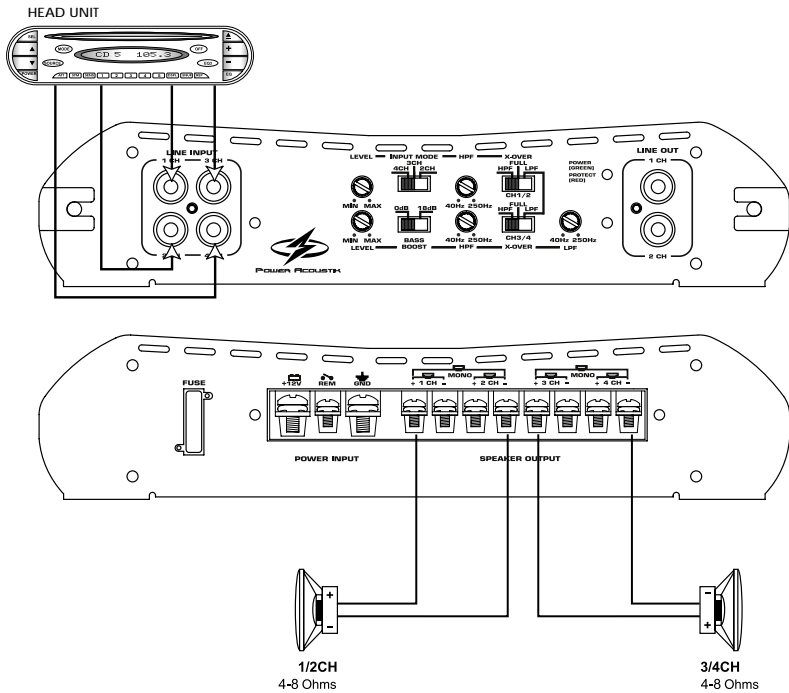

- 1.Lowest Recommended Impedance is 4ohm Stereo
- 2.RCA Inputs are connected to both Left and Right channels
- 3.Output configured for stereo operation

TROUBLE SHOOTING GUIDE

SYMPTOMS	CHECK POINTS	CURE
NO SOUND	Is the power LED illuminated?	Check fuses in amplifier. Be sure Turn-on lead is connected
AMP NOT SWITCHING ON	No power to power wire	Repair power wire or connections
	No power to remote wire with receiver on	Check connections to radio
	Fuse broken	Check fuse
NO SOUND IN ONE CHANNEL	Check speaker leads	Inspect for short circuit or an open connection.
	Check audio input leads	Reverse Left and Right RCA inputs to determine if it is occurring before the amp. Check Tuner/Deck volume level. Clean contacts on fuse holders.
AMP TURNING OFF MEDIUM/ HIGH VOLUME	Check speaker load impedance	Be sure proper speakers are used to ensure impedance recommendations are observed. (If you use an Ohmmeter to check speaker resistance, please remember that DC resistance and AC impedance may not be the same.)

SPECIFICATIONS

MODEL#	OVN2-600	OVN2-800	OVN2-1250	OVN2-1800	OVN2-2200	OVN4-840	OVN4-1200
MAXIMUM POWER OUTPUT	600W	800W	1250W	1800W	2200W	840W	1200W
POWER OUTPUT @4Ohm	2 X 95W	2 X 150W	2 X 220W	2 X 300W	2 X 370W	4 X 80W	4 X 100W
POWER OUTPUT @2Ohm	2 X 120W	2 X 180W	2 X 280W	2 X 380W	2 X 450W	4 X 95W	4 X 125W
BRIDGED POWER	1 X 210W	1 X 360W	1 X 560W	1 X 760W	1 X 900W	2 X 190W	2 X 250W
THD	0.02%	0.02%	0.02%	0.02%	0.02%	0.02%	0.02%
FREQUENCY RESPONSE -1.0dB	10Hz-30kHz	10Hz-30kHz	10Hz-30kHz	10Hz-30kHz	10Hz-30kHz	10Hz-30kHz	10Hz-30kHz
HPF	40Hz-250Hz	50Hz-500Hz	50Hz-500Hz	50Hz-500Hz	50Hz-500Hz	40Hz-250Hz	40Hz-250Hz
LPF	40Hz-250Hz	30Hz-500Hz	30Hz-500Hz	30Hz-500Hz	30Hz-500Hz	40Hz-250Hz	40Hz-250Hz
SUBSONIC FILTIER	-	30Hz-175Hz	30Hz-175Hz	30Hz-175Hz	30Hz-175Hz	-	-
BASS BOOST	0dB, 18dB	0dB ~ 24dB	0dB ~ 24dB	0dB ~ 24dB	0dB ~ 24dB	0dB, 18dB	0dB, 18dB
ADJUSTABLE SENSITIVITY RANGE	0.2V-6V	0.2V-3V	0.2V-3V	0.2V-3V	0.2V-3V	0.2V-6V	0.2V-6V
INPUT IMPEDANCE (LOW LEVEL)	10K Ohms	10K Ohms	10K Ohms	10K Ohms	10K Ohms	10K Ohms	10K Ohms
FUSE	25A x 1	40A x 1	25A x 2	30A x 2	25A x 3	40A x 1	25A x 2
DIMENSION (D x W x H inch)	8.1" x 10.6" x 2.9"	10.8" x 10.6" x 2.9"	12.8" x 10.6" x 2.9"	14.8" x 10.6" x 2.9"	20.3" x 10.6" x 2.9"	10.8" x 10.6" x 2.9"	12.8" x 10.6" x 2.9"

SPECIFICATIONS

MODEL#	OVN4-1600	OVN1-1800D	OVN1-3000D	OVN1-4000D	OVN1-5500D
MAXIMUM POWER OUTPUT	1600W	2000W	3000W	4000W	5500W
POWER OUTPUT @4Ohm	4 X 150W	1X 600W	1X 800W	1X 1200W	1X 1700W
POWER OUTPUT @2Ohm	4 X 180W	1 X 900W	1 X 1200W	1 X 1700W	1 X 2500W
POWER OUTPUT @10hm	-	1 X 1200W	1 X 1700W	1 X 2200W	1 X 3200W
BRIDGED POWER	2 X 360W	-	-	-	-
THD	0.02%	0.5%	0.5%	0.5%	0.5%
FREQUENCY RESPONSE -1.0dB	10Hz-30kHz	20Hz-200Hz	20Hz-200Hz	20Hz-200Hz	20Hz-200Hz
HPF	40Hz-250Hz	-	-	-	-
LPF	40Hz-250Hz	40Hz-200Hz	40Hz-200Hz	40Hz-200Hz	40Hz-200Hz
SUBSONIC FILTER	-	20Hz-50Hz	20Hz-50Hz	20Hz-50Hz	20Hz-50Hz
BASS BOOST	0dB, 18dB	0dB- 18dB	0dB- 18dB	0dB- 18dB	0dB- 18dB
ADJUSTABLE SENSITIVITY RANGE	0.2V-6V	0.2V-6V	0.2V-6V	0.2V-6V	0.2V-6V
INPUT IMPEDANCE (LOW LEVEL)	10K Ohms	10K Ohms	10K Ohms	10K Ohms	10K Ohms
FUSE	20A x 3	30A x 2	40A x 2	30A x 4	40A x 5
DIMENSION (D x W x H inch)	17.9" x	10.8" x	12.8" x	14.8" x	19.1" x
	10.6" x 2.9"	10.6" x 2.9"	10.6" x 2.9"	10.6" x 2.9"	10.6" x 2.9"

WARNINGS

Investigate the layout of your automobile thoroughly before drilling or cutting any holes. Take care when to work near the gas tanks, lines, or hydraulic lines, and electrical wiring. Don't use power amplifier unmounted. Attach this system securely to the automobile to prevent damage, particularly in the event of an accident. Don't mount this system so that the wire connections are unprotected or are subject to pinching or damage from nearby objects. The +12V DC power wire must be fused at the battery positive terminal connection. Before making or breaking power connections at this system power terminals, disconnect the +12V wire at the battery end. Confirm your radio/cassette player and/or other equip is turned off while connecting the input jacks and speaker terminals. If you need to replace the power fuse, replace it only with a fuse identical to that supplied with the system. Using a fuse of different type or rating may result in damage to this system which isn't covered by the warranty.



POWER ACOUSTIK