

OWNER'S MANUAL

Mobile Video System

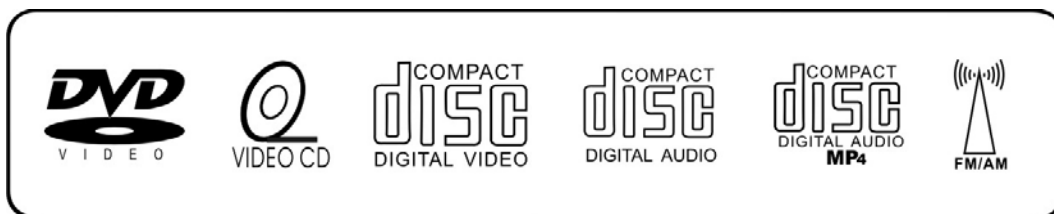
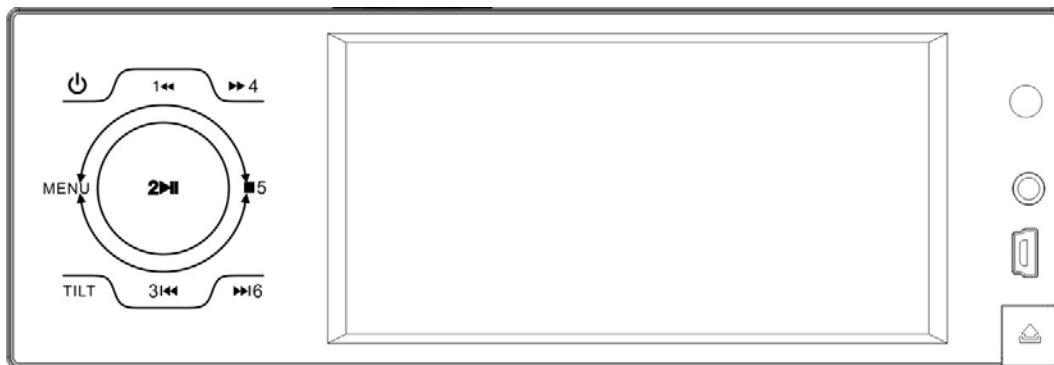

TABLE OF CONTENTS

Table of Contents.....	1
Safety Information.....	2
Features.....	3
Accessories.....	4
Wire Connection.....	5
Unit Installation and Removal.....	8
Front Panel.....	12
Base Panel.....	13
Remote Control.....	14
Touch Screen Operations.....	19
Touch Screen Calibrate.....	19
Main Menu.....	20
Radio Operations.....	21
DVD Operations.....	22
iPod Operations.....	27
SD Operations.....	28
USB Operations.....	28
AV IN Operations.....	29
AUX Operations.....	29
NAVI Operations.....	30
ATSC Operations.....	34
System Parameters Setup.....	35
Specifications.....	38
Troubleshooting.....	39
Disc Notes.....	41

SAFETY INFORMATION

Please read the manual carefully before operating this unit and keep it for future reference.

CAUTION: This unit is a class 1 laser product. To prevent direct exposure to the laser system, do not open the unit. The laser beam may hurt your eyes. If the unit requires adjustments, contact an authorized service centre.

USE THIS PRODUCT SAFELY

Be sure you fully understand the following safety information:

When driving

Keep the unit at an appropriate sound level. Driving with the sound at a level preventing you from hearing sounds outside and around the car may cause an accident.

When cleaning

Do not expose the product to water or excessive moisture. This could cause short circuit, fire or other severe damage.

When parked

Parking in direct sunlight can result in very high temperature levels inside your car. Let the interior and unit cool down before switching the unit on.

NOTE:

Do not use and store the player in dusty, hot or humid environment.

FUSE REPLACEMENT – WARNING!



Never replace any fuse with one of a higher value than the fuse supplied with your unit. Using a higher current rated fuse may cause damage to your unit and/or electrical wiring.

FEATURES

- Motorized TFT-LCD w/ 4 Pre-Set Angles & Last Angle Memory
- Theft Deterrent Detachable Faceplate
- Accepts Add-On GPS Navigation Module, NAVIBOX-1
- Accepts Add-On Digital TV Tuner Module, DTV-1
- Car-Spec DVD Transport for Extreme Temperature Exposure
- Playback from DVDR/RW & CDR/RW Including VCD, MP3, MP4 & DiviX
- Recall Memory for Last DVD Position
- i-Pod Input Connection (requires IP-1C cable)
- Mini-USB Connection for MP3 & MP4 Playback From 4GB Flash Drive
- 4GB SD Card Reader for MP3, MP4, DiviX & Xvid Playback
- 1GB Internal Memory for Background & Screen Saver Images
- 18 FM / 12 AM Station Memory
- 50w x 4 MOSFET Powered Speaker Level Outputs
- Front & Rear Pre-Amp Outputs
- Dedicated Variable Subwoofer Pre-Amp Output w/ LPF (80, 120, 160Hz)
- A/V Outputs for Multiple Components
- A/V Inputs for Secondary Source
- Front Panel 3.5mm Auxiliary A/V Input
- Reverse Camera Input w/ Trigger
- Custom & Pre-Set EQ Settings
- Audio Staging Controls
- 12/24 Hour Clock
- USA/European Frequency Stepping
- NTSC/PAL Auto Selection
- 432 x 242 Screen Resolution
- 400cd Backlight Brightness

NOTE:

This user's manual is only for reference.

Modifying rights are reserved.

Specifications are subject to change without notice.

ACCESSORIES

1

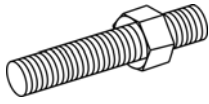

Bolt x 1

2

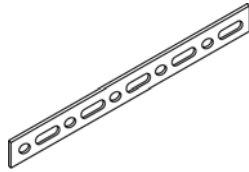

Back Strap x 1

3



M5X5 Screws x 4

4

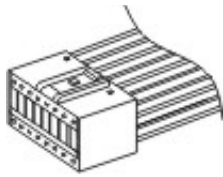

Power Wire x 1

5

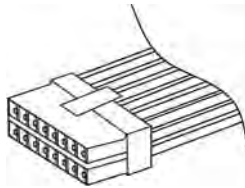

Connector Wire x 1
(White)

6

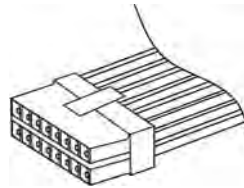

Connector Wire x 1
(Yellow)

7

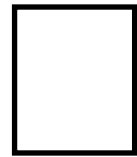

Operational Manual x 1

8



Trim Bezel x 1

9

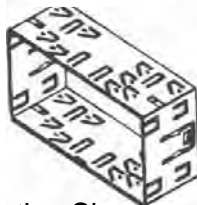

Mounting Sleeve x 1

10

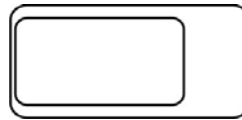

Remote Control x 1

11



USB Cable x 1

12



Faceplate Case x 1

13



Keys x 2

14



iPod Cable x 1
(Optional)

15

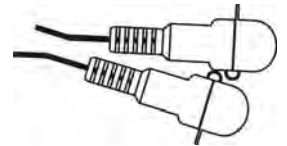

AUX Cable x 1

WIRE CONNECTION

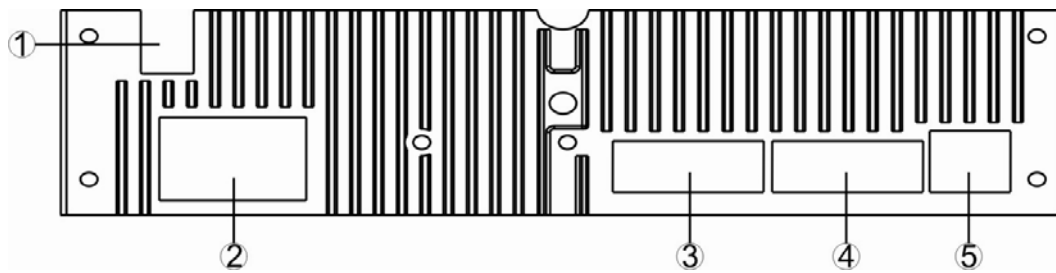

1. RADIO & ANALOG TV ANTENNA (OPTIONAL)
2. 15PIN SOCKET
3. AUDIO /VIDEO OUTPUT & INPUT
4. NAVI & DIGITAL TV ADAPTER (OPTIONAL)
5. IPOD ADAPTER

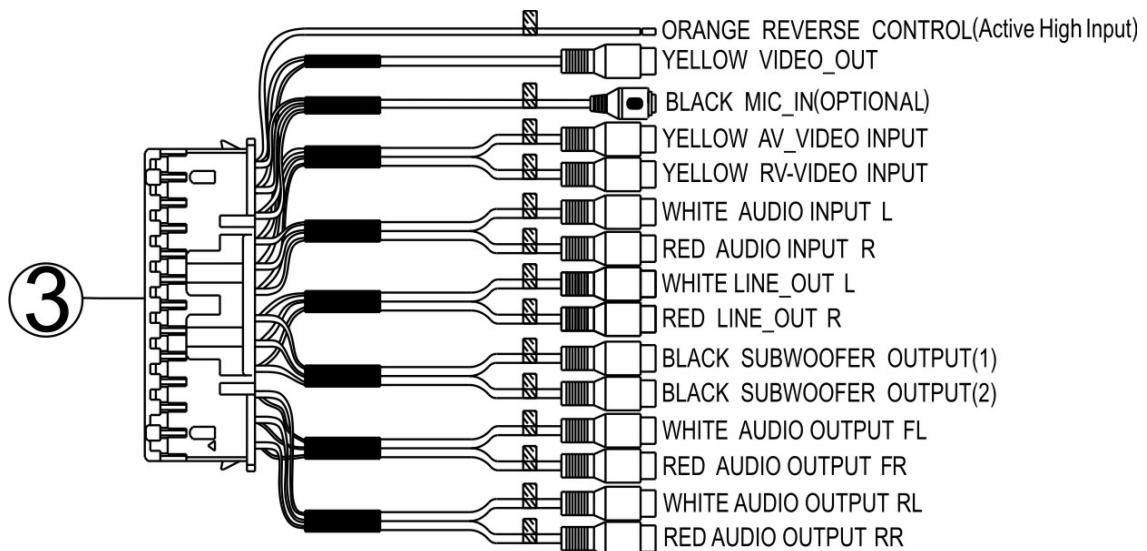
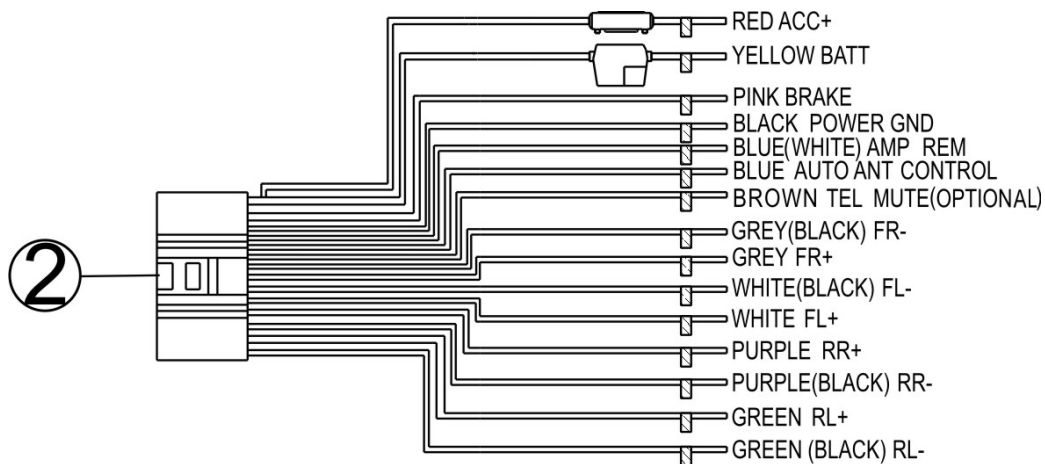

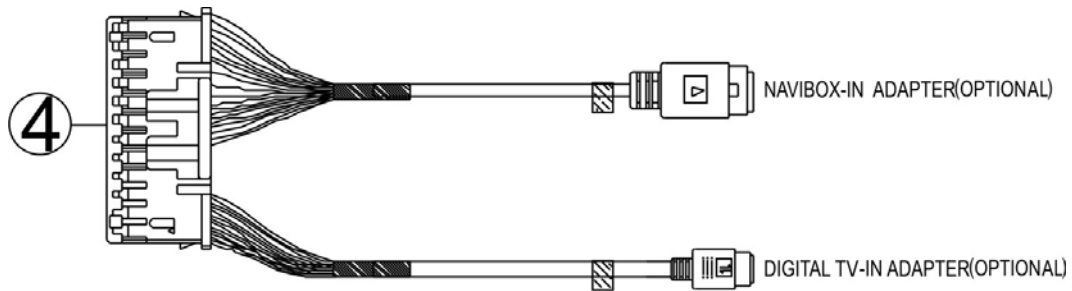

Brake Control

Connect the brake control wire AUTO_ANT (see Wiring Diagram). It is necessary to connect the Brake Control wire to the Hand-brake switch of the car. While driving, the TFT monitor will display the alarm picture (see as follows) in order to ensure the safety.

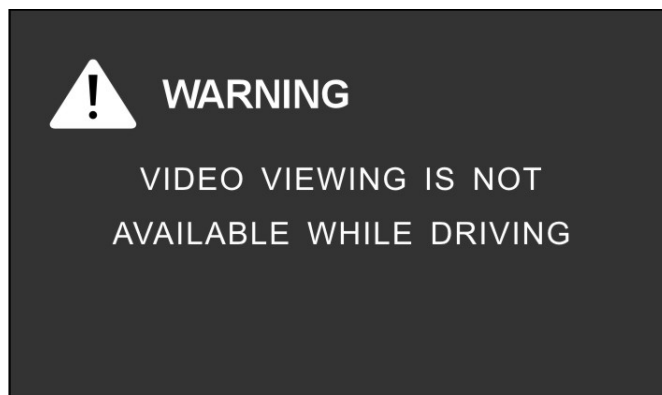

Under the Rear View Mode, the Brake Control function is no effective.

Telephone Mute Control (Optional)

Connect the telephone mute control wire TEL_MUTE (see Wiring Diagram). If there is a vehicle call comes in, the sound volume will mute off automatically, and TFT monitor shows: PHONE...; when call finished, the sound volume will recover to former volume, and the words PHONE... disappear.

Auto Antenna Control

Connect the auto antenna control wire AUTO_ANT (see Wiring Diagram). The antenna will lift when the unit startup; it will descend when the unit turnoff.

Wiring Diagram

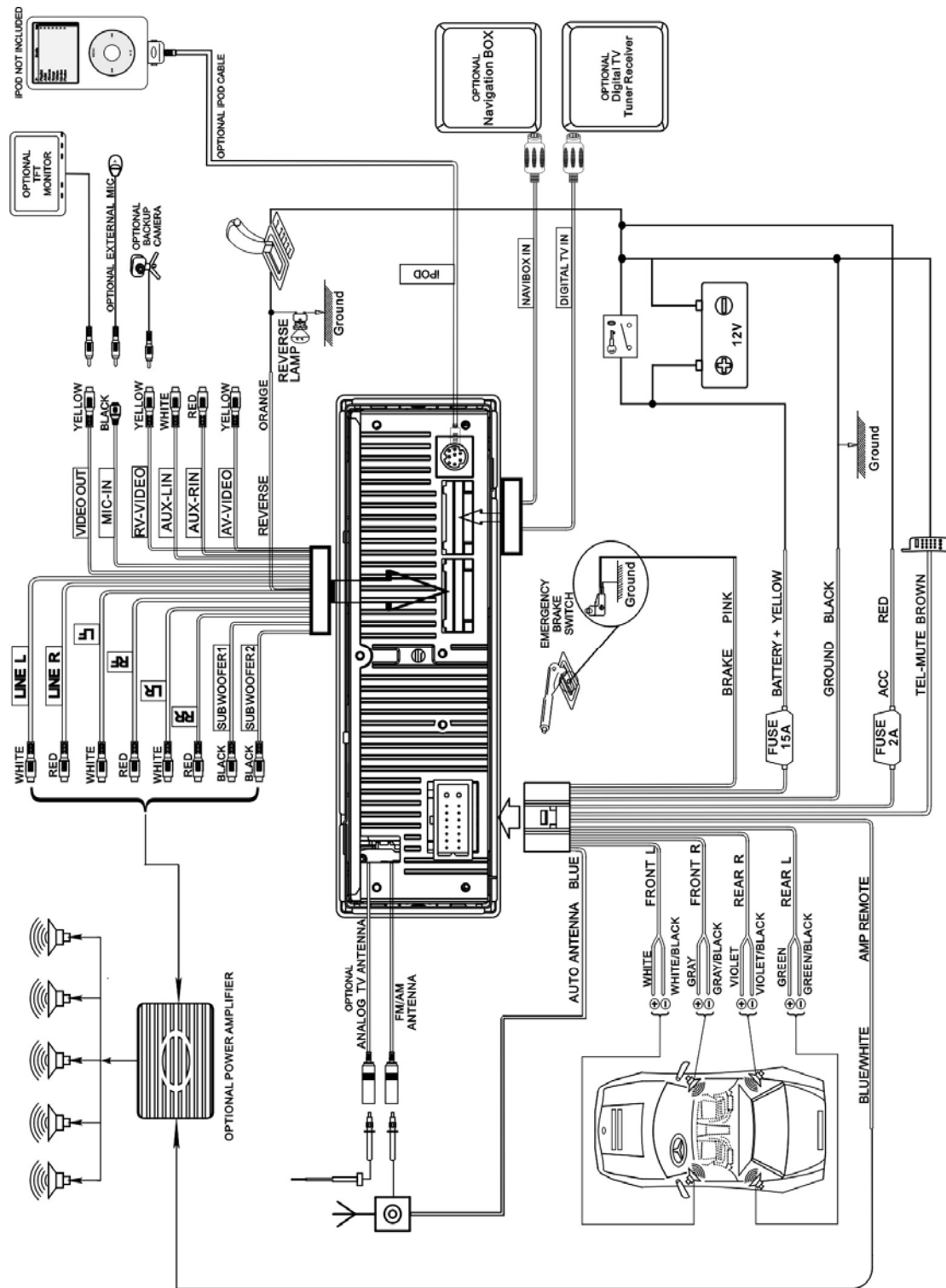

UNIT INSTALLATION AND REMOVE

Installation Method 1:

1 Install the mounting sleeve into the dashboard.

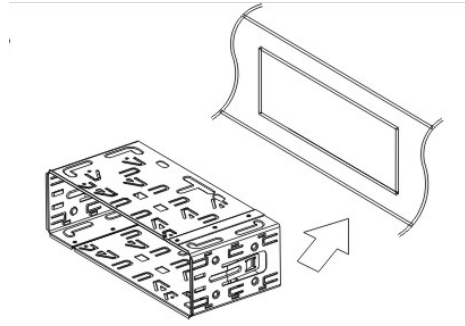

2 Bend the claws into place to secure the sleeve.

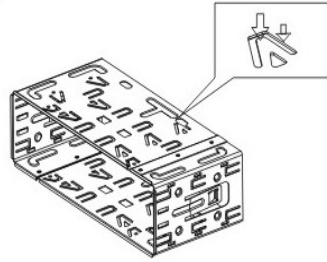

3 Slide the units into the mounting sleeve.

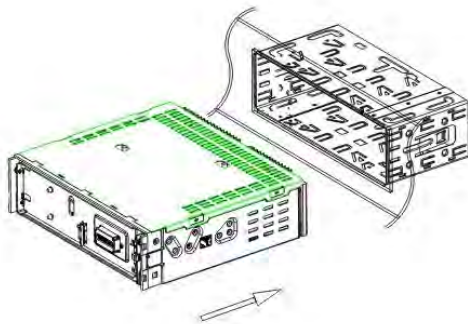

4 Install the trim bezel onto the unit.

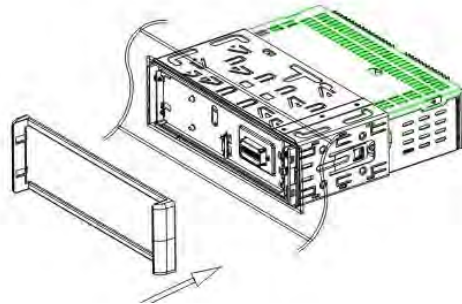

5 Install the face panel onto the unit.

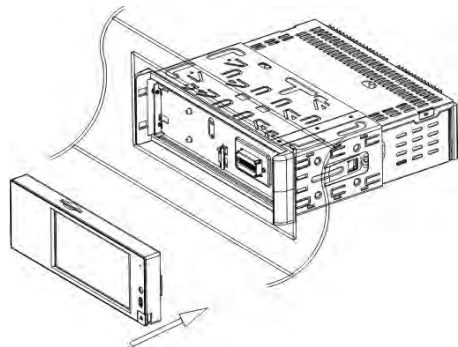

6 Sketch map when installation finished.

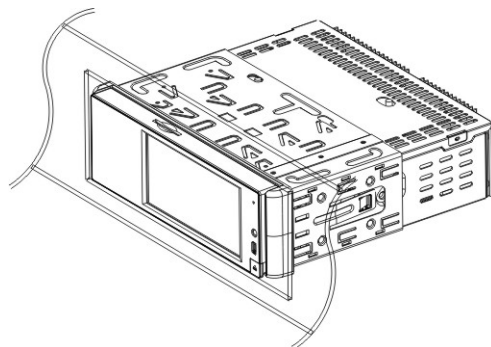

Removal Method 1:

1 Detach the face panel by pushing the release button.

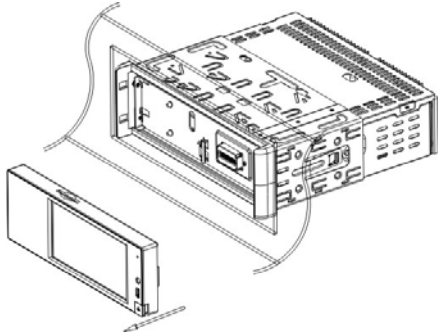

2 Detach the trim bezel.

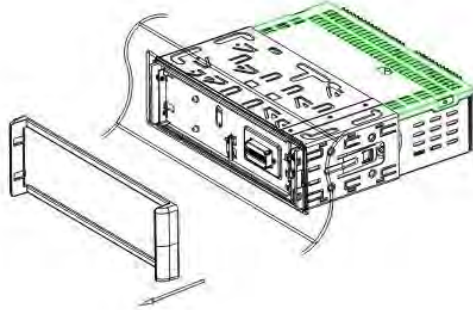

3 Insert the keys into the aperture between the unit and the mounting sleeve to release the internal locks.

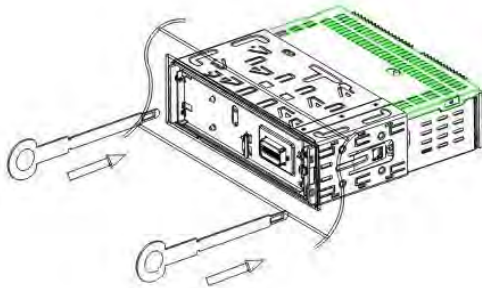

4 Pull the unit out of the mounting sleeve.

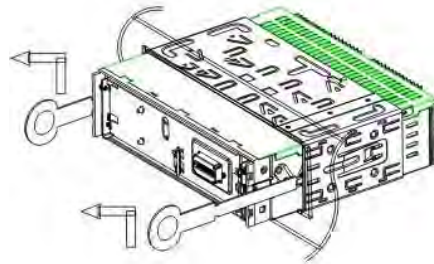

5 Sketch map when removal finished.

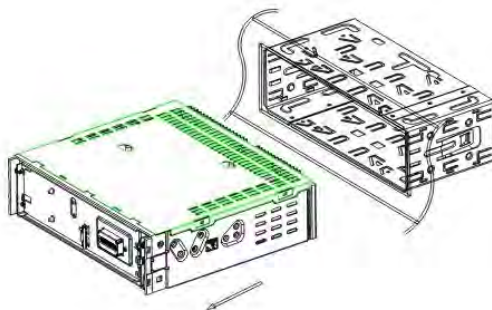

Installation Method 2:

1 Tighten the bolt onto the rear panel of the unit.

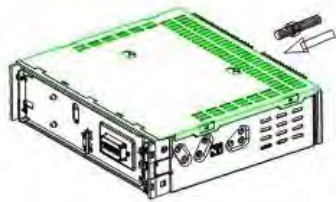

2 Tighten the back strap onto your car inside the dashboard.

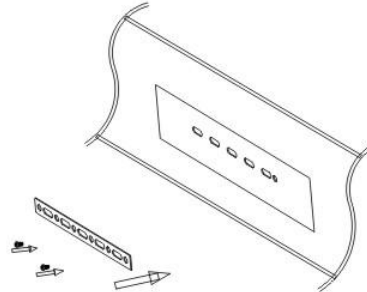

3 Place the unit into the dashboard; make the bolt bar across back strap; and then fix the bolt by the Nut M5.

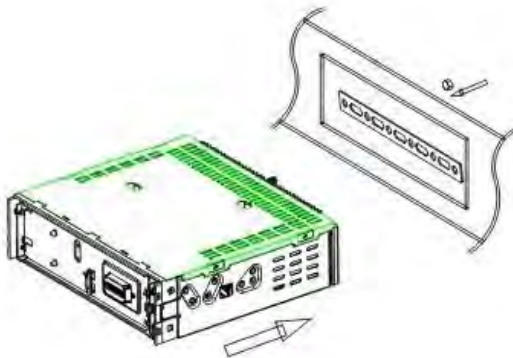

4 Screw the unit on the car on the two sides with M5x5 SCREWS.

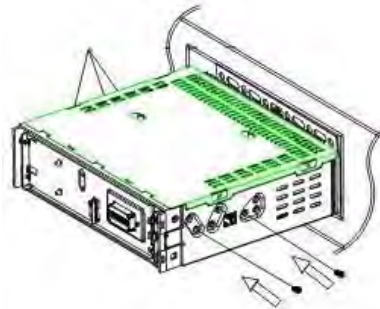

5 Install the trim bezel onto the unit.

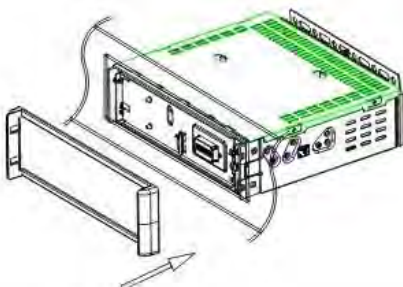

6 Install the face panel onto the unit.

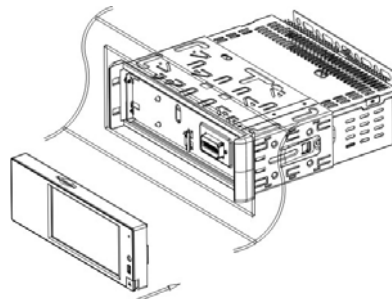

Removal Method 2:

1 Detach the front panel by pushing the release button.

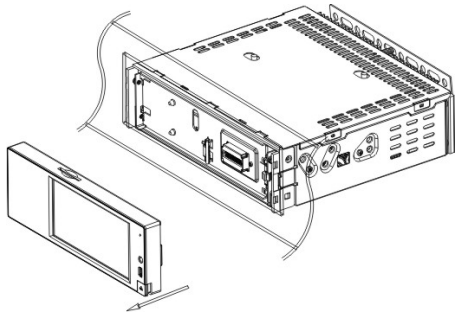

2 Detach the trim bezel.

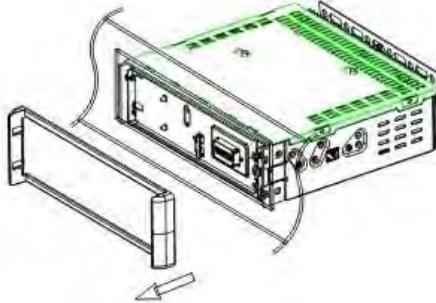

3 Unscrew the unit off the car on the two sides.

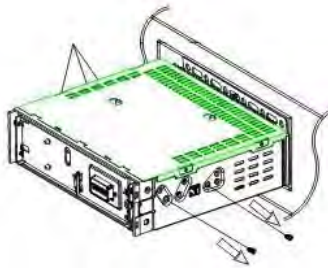

4 Unscrew the Nut M5 screw on the rear side of the unit and pull out the unit.

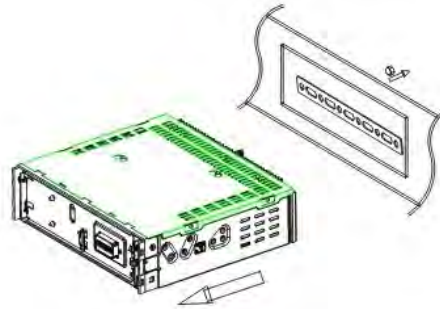

5 Sketch map when removal finished.

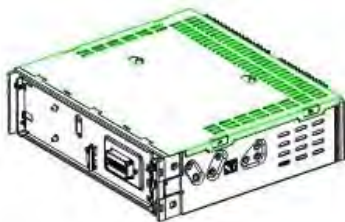

FRONT PANEL

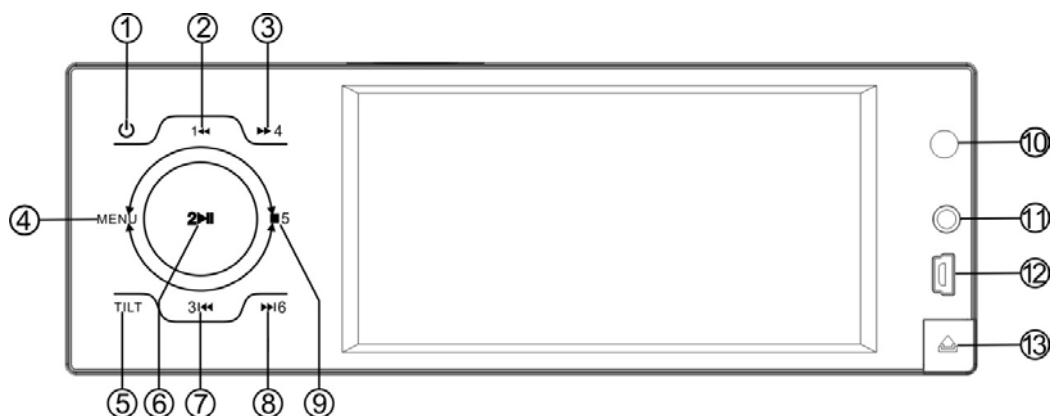

- | | | |
|------------|------------|-----------------|
| 1. POWER | 2. F. REV | 3. F. FWD |
| 4. MENU | 5. TILT | 6. PLAY / PAUSE |
| 7. PREV | 8. NEXT | 9. STOP |
| 10. REMOTE | 11. AUX IN | 12. MIN USB |
| 13. REL | | |

1. Power

When ACC is on, touch the button to turn the unit on; hold on touching the button to turn off the unit.

When the unit is on, touch to switch between different modes.

2. / 3. Fast Forward / Fast Reverse

Touch to fast forward / fast reverse at 2x speed. Each touch changes speed from 2x to 4x to 8x to 16x to 32x then back to normal play. Touch the [PLAY/PAUSE] icon to resume to normal playback.

4. Menu / Navi

Touch to access the Main Menu.

Hold on touching to access the GPS mode.

5. Tilt

Inserting Disc

Touch the [TILT] button, the front panel will slide down to Position 1; then insert a disc into the Disc Loading Slot; the panel will slide back automatically.

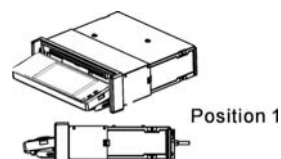

Ejecting Disc

Touch the [TILT] button, the front panel will slide down to Position 1; then eject a disc; the panel will slide back automatically if no action is taken.

TFT Viewing Angle Adjustment:

Hold on touch the [TILT] button to adjust the viewing angle as following:

Angle 1- Angle 2- Angle 3- Angle 4- Angle 1



Angle 1



Angle 2



Angle 3



Angle 4

6. Play/Pause

Touch to pause or resume the playback.

7. Next / 8. Previous

Touch to go to the next / pervious chapter, track or song.

9. Stop

When DVD/VCD/CD disc playback, touch the icon once to stop the playback, touch the [Play/Pause] icon to resume the playback again. Touch the icon twice to stop the playback, touch the [Play/Pause] icon to start the playback from the beginning of disc. When MP3 disc playback, touch the icon to stop the playback, touch the [Play/Pause] icon to start the playback from the beginning of track.

10. Remote

Remote infrared receiver.

11. AUX IN

Connect an external audio device to this jack to listen to the device through your car speakers.

12. Mini USB

The unit will be switched to DVD Mode automatically when USB connected, and play the songs, pictures, videos in USB.

13. REL

Press to take off the panel for burglar-proof purpose.

Preset Stations

Radio Mode, touch the icons [1, 2, 3, 4, 5, 6] to select a preset station, hold on touching to store current radio frequency to the preset station.

BASE PANEL

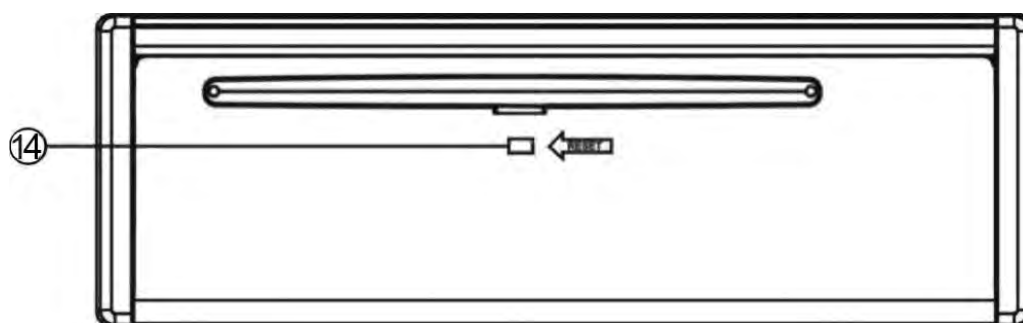

14. RESET

If the unit ever needs to be reset, you can do so by removing the face plate to gain access to the reset button.

Press and hold this button to switch back to all the original factory settings.

Keep in mind this will erase all your preset radio stations and any EQ settings you may have made and saved.

REMOTE CONTROL

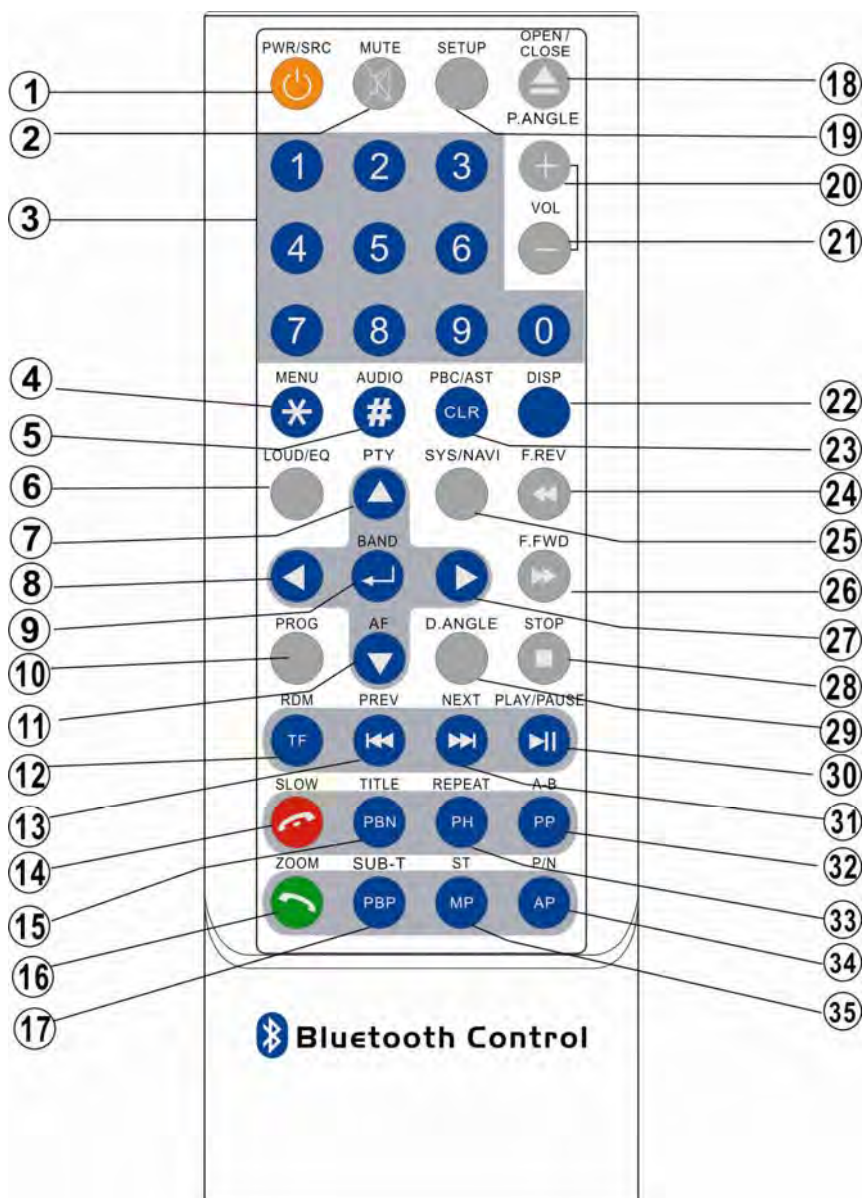

- | | | |
|------------------------|-----------------------------------|----------------------|
| 1. POWER/SOURCE | 13. PREVIOUS | 25. SYSTEM / NAVI |
| 2. MUTE | 14. SLOW / END CALL | 26. F.FWD |
| 3. NUMBER BUTTONS | 15. TITLE / PBN | 27. RIGHT(Seek up) |
| 4. MENU / * | 16. ZOOM / CALL | 28. STOP |
| 5. AUDIO / # | 17. SUBTITLE / PBP | 29. D.ANGLE |
| 6. EQ / LOUD | 18. OPEN / CLOSE / P.ANGLE/ EJECT | 30. PLAY / PAUSE |
| 7. UP (TUNE UP)/PTY | 19. SETUP | 31. NEXT |
| 8. LEFT (SEEK DOWN) | 20. VOLUME+ | 32. A-B / PHONE PAIR |
| 9. ENTER / BAND | 21. VOLUME- | 33. REPEAT / PHONE |
| 10. PROGRAM | 22. DISPLAY | 34. PAL / NTSC / AP |
| 11. DOWN(Tune Down)/AF | 23. PBC / AST / CLEAR | 35. STEREO / MP |
| 12. RANDOM / TRANSFER | 24. F.REV | |

NOTE:

This is a universal remote, some functions would be optional.

1. [POWER/SOURCE]

When ACC is on, press the button to turn the unit on; hold on pressing the button to turn off the unit.

When the unit is on, press to switch between different modes.

2. [MUTE]

Press to switch off the sound; press it again to resume to the previous volume level.

3. [NUMBERS 0~9]

Radio Mode, press the buttons 1~6 to select a preset station, hold on touching to store current radio frequency to the preset station.

DVD Mode, When playing DVD, VCD, CD, MP3, press the buttons 0~9 to input the number of track, press the [BAND] button to confirm.

TV Mode, press the buttons 0~9 to choose the channel and press the [BAND] button to confirm.

Bluetooth Mode, press the buttons 0~9 to input phone numbers.

4. [MENU / *]

DVD Mode, press to return to the boot menu when playing DVD disc.

Bluetooth Mode, press to input the symbol *.

5. [AUDIO / #]

DVD Mode, press to change dialogue language when playing DVD disc; Press to select different audio channels when playing VCD, CD disc.

Bluetooth Mode, press to input the symbol #.

6. [LOUD/EQ]

Press to adjust the EQ setting as following:

USER – POP – CLASSIC – ROCK – JAZZ – USER

Hold on pressing to switch between LOUD ON / OFF.

7. [^] / 8. [<] / 11. [v] / 27. [>] Direction Key

DVD Mode and System Parameters Setup, press the [v] / [^] buttons to move the cursor upward / downward to select item. Press the [<] / [>] buttons to move the cursor leftward / rightward to select item.

Radio Mode, press the [<] / [>] buttons to switch the stored stations. Hold on pressing the [<] / [>] buttons to fast seeking the next available channel by decreasing / increasing the tuning frequency; seeking will stop by pressing any button. Press the [v] / [^] buttons to decrease / increase the frequency step by step. Hold on pressing the [v] / [^] buttons to fast seeking by decreasing / increasing the tuning frequency; seeking will stop when loose the button.

TV Mode, hold on pressing the [<] / [>] buttons to fast tuning channel forward the low / high frequency automatically. Press the [^] / [v] buttons to select the stored channel upward / downward.

Bluetooth Mode, press [<] / [>] buttons to switch between dialing page, phonebook, music and setup page.

GPS Mode, press the [V] / [^] buttons to decrease / increase the brightness of the screen.

9. [BAND/ENTER]

DVD Mode, press to confirm the selection.

Radio Mode, press to switch the wave band as following:

FM1 – FM2 - FM3 - AM1- AM2 - FM1

TV Mode, press to switch the TV audio as following:

NTSC – PAL/BG – PAL/I – PAL/DK – NTSC

Hold on pressing to switch the TV system area as following:

USA – CCIR – ITALY – AUS – NZ – USA

Bluetooth Mode, press the button to turn on/off selected item.

10. [PROGRAM]

DVD Mode, press to enter / exit the PROGRAM Function when playing the DVD, VCD, CD disc.

12. [RANDOM/TRANSFER]

DVD Mode, press to turn RANDOM function on / off when playing DVD, VCD, CD disc.

Bluetooth Mode, press to transfer the call between the unit and your cell phone when talking the phone.

13. [PREVIOUS] / 31. [NEXT]

DVD Mode, press to go to the pervious / next chapter, track or song.

14. [SLOW/END CALL]

DVD Mode, press to slow motion playback at 1/2x speed when playing DVD/VCD disc. Each press changes speed from 1/2x to 1/4x to 1/8x to 1/16x then back to normal play.

Bluetooth Mode, press to reject or hang up a call.

15. [TITLE/PBN]

DVD Mode, press to enter the title menu when playing DVD disc.

Bluetooth Mode, press to enter the next page of phone number list in phonebook.

16. [ZOOM/CALL]

DVD Mode, press to zoon the picture display when playing DVD, VCD disc. Each press changes speed from 2x to 3x to 4x to 3x to 2x then back to normal play.

Bluetooth Mode, press to call a number or to receive a cell phone call.

17. [SUB-T/PBP]

DVD Mode, press to change the subtitle language when playing DVD disc.

Bluetooth Mode, press to enter the previous page of phone number list in phonebook.

18. [OPEN/CLOSE/P.ANGLE/EJECT]

Press the button to open the monitor to eject the disc, press it again to close the monitor.

Hold pressing the button to enter into adjusting mode, press it again to adjust the angle of the front panel as following:

Angle 1 - Angle 2 - Angle 3 - Angle 4 - Angle 1

19. [SETUP]

DVD Mode, press to enter/ exit the DVD SETUP menu.

20. [VOL+] / 21. [VOL-]

Press to increase / decrease the volume.

Hold on pressing the button to keep increasing/decreasing the volume.

22. [DISPLAY]

DVD Mode, press to display current playback information.

Bluetooth Mode, press to return to the previous page.

23. [PBC/AST/CLEAR]

DVD Mode, press to select the PBC function on / off when playing VCD disc.

Radio Mode, press to review stored stations; Hold on pressing to automatically program the 6 strongest stations available into the presets in the each wave band.

TV Mode, automatically seek the stations available.

Bluetooth Mode, press to cancel or clear the numbers you have input.

24. [F.REV] / 26. [F.FWD]

DVD Mode, press to fast reverse / fast forward at 2x speed. Each press changes speed from 2x to 4x to 8x to 16x to 32x then back to normal play. Press the [PLAY/PAUSE] button to resume to normal playback.

25. [SYSTEM/NAVI]

Press to enter / exit the System Parameter Setup menu when playing DVD, VCD and CD disc.

Hold on pressing to enter / exit the NAVI Mode.

28. [STOP]

DVD Mode, when DVD/VCD/CD disc playback, press the button once to stop the playback, press the [Play/Pause] button to resume the playback again. Press the button twice to stop the playback, press the [Play/Pause] button to start the playback from the beginning of disc. When MP3 disc playback, press the button to stop the playback, press the [Play/Pause] button to start the playback from the beginning of track.

29. [D.ANGLE]

DVD Mode, press to select different viewing angles with interactive DVD media during playback.

30. [PLAY/PAUSE]

DVD Mode, press to pause or resume the playback.

32. [A-B/PHONE PAIR]

DVD Mode, press to set point A, press it again to set point B, then the unit starts to repeat from A to B. When playing DVD, MP3, press it again to stop repeating. When playing VCD, CD, press it again to repeat all tracks.

Bluetooth Mode, press to start phone-pairing.

33. [REPEAT/PHONE]

DVD Mode, press to repeat as CHAPTER-TITLE-ALL-REPEAT OFF when DVD playback. Press to repeat as TRACK-ALL-REPEAT OFF when VCD/CD playback. Press to repeat as REPEAT ONE-REPEAT ALL-REPEAT OFF when MP3 playback.

Bluetooth Mode, press to break off or connect cell phone with the unit.

34. [P/N/AUDIO PLAYER]

DVD Mode, press to switch the video output (PAL/NTSC) when playing DVD disc.

Bluetooth Mode, press to enter into AUDIO PAIRING.

35. [STEREO/MUSIC PAIR]

Radio Mode, press to turn the stereo on / off under.

Bluetooth Mode, press to break off or connect the music storage medium with the unit.

REPLACING THE BATTERIES

If the remote control has no function or if the operating range reduced, replace the old battery with new one.

1. Pull out the battery holder. Follow the arrow 1 slide it to the right toward the battery while at the same time pull the battery holder away from the remote control.
2. Place the new battery. Place the new lithium battery with the (+) side up.
3. Push the holder back. Using the finger to push in the holder back until the locking sound is heard.

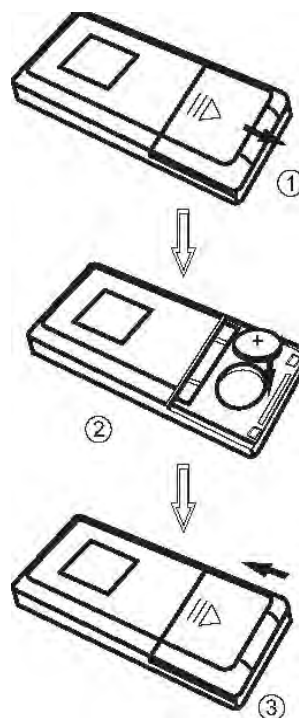

TOUCH SCREEN OPERATIONS

TOUCH SCREEN CALIBRATION

When "Power Off", press the buttons 2, [BAND] of remote control to enter the CALIBRATION page:

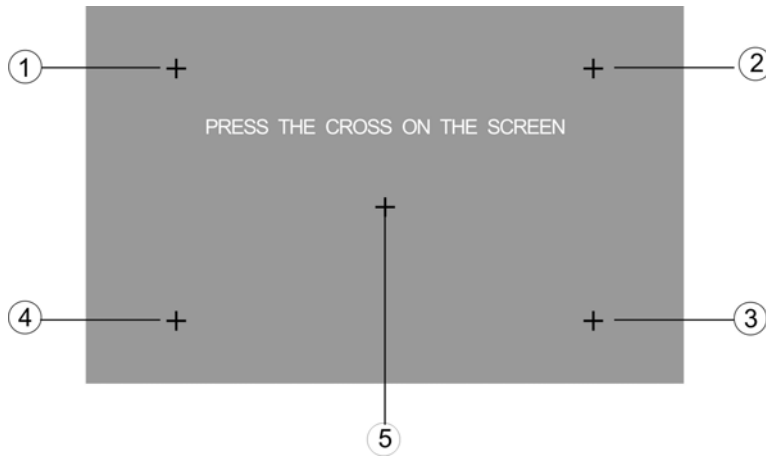

To touch the points from 1 to 5 until the points change to next cross by using a ballpoint pen or pencil. After all 5 points have been touched, the unit has been finished the CALIBRATION. If the calibration is succeeded, the unit would display the following page and then power off automatically.

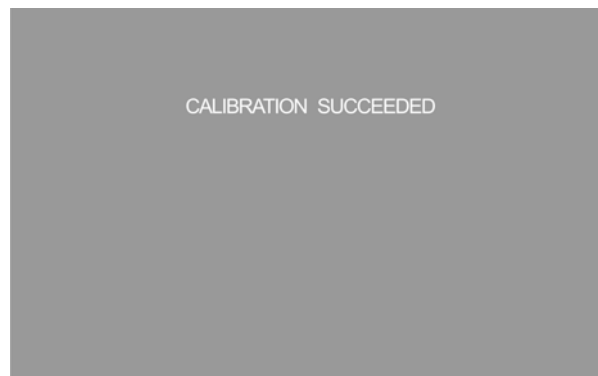

If the calibration is failed, the unit would display the following page and please operate the above processes again.



MAIN MENU



- 1, Touch to access the **DVD** mode.
- 2, Touch to access the **RADIO** mode.
- 3, Touch to access the **iPod** mode.
- 4, Touch to access the **ATSC** mode.
- 5, Touch to access the **GPS** mode.
- 6, Touch to access the **SD CARD** mode.
- 7, Touch to access the **USB** mode.
- 8, Touch to access the 2nd page of MAIN MENU.



- 1, Touch to access the **AV IN** mode.
- 2, Touch to access the **AUX** mode.
- 3, Touch to access the **SYSTEM PARAMETERS SETUP**.
- 4, Touch to access the 1st page of MAIN MENU.
- 5, Touch to access the previous working mode.

RADIO OPERATIONS

Touch the [RADIO] icon to access to Radio Mode.



1. Current Source Indicator

Displays the source currently playing, touch to return the main menu.

2. Mute

Touch to switch off the sound; touch it again to resume to the previous volume level.

3. Preset Stations

Touch to select a preset station, hold on touching to store current radio frequency to the preset station.

4. BAND

Touch the icon to switch the FM/AM wave band as following:
FM1 - FM2 - FM3 - AM1- AM2 - FM1

5. Auto Station Tune

Touch to automatically program the 6 strongest stations available into the presets in the each wave band; touch any icon to stop the tuning. After tune, the unit will scan through all tunable presets stations and play them for 5 seconds each; touch any icon to stop the playing.

6. / 7. Tune Frequency - Down / Up

Touch to tune the radio to a lower / higher frequency by one frequency step. Hold on touching for continuous tuning down / up.

8. / 9. Seek Next Station – Down / Up

Touch to tune to the next strong station at a lower / higher frequency. Touch any icon to stop seeking.

DVD PLAYER OPERATIONS

- 1, Touch the [DVD] icon to access to DVD Mode if disc inside.
- 2, The unit will be switched to DVD Mode automatically when inserting the disc.
- 3, The unit will switch to RADIO Mode automatically if disc ejected.

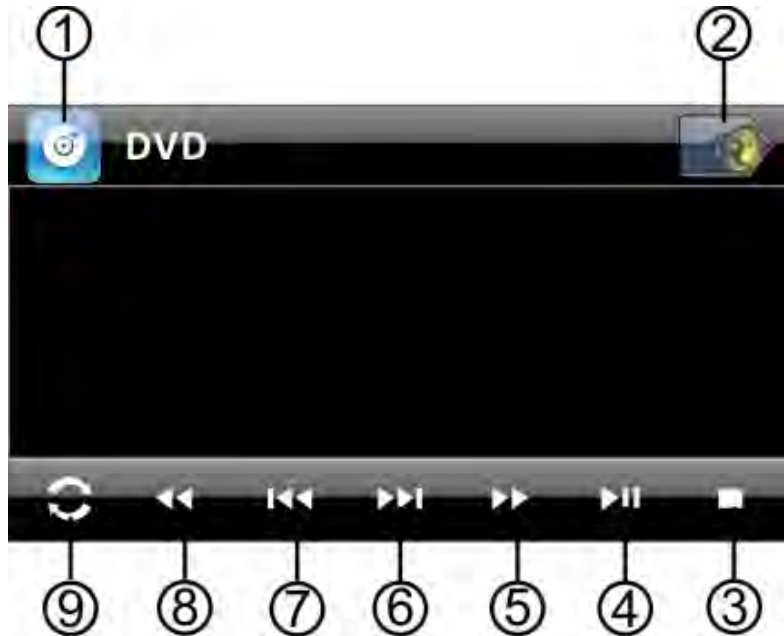

1. Current Source Indicator

Displays the source currently playing, touch to return the main menu.

2. Mute

Touch to switch off the sound; touch it again to resume to the previous volume level.

3. Stop

When DVD/VCD/CD disc playback, touch the icon once to stop the playback, touch the [Play/Pause] icon to resume the playback again. Touch the icon twice to stop the playback, touch the [Play/Pause] icon to start the playback from the beginning of disc. When MP3 disc playback, touch the icon to stop the playback, touch the [Play/Pause] icon to start the playback from the beginning of track.

4. Play/Pause

Touch to pause or resume the playback.

5. / 8. Fast Forward / Fast Reverse

Touch to fast forward / fast reverse at 2x speed. Each touch changes speed from 2x to 4x to 8x to 16x to 32x then back to normal play. Touch the [PLAY/PAUSE] icon to resume to normal playback.

6. Next / 7. Previous

Touch to go to the next / pervious chapter, track or song.

9. Switch

Touch to access the 2nd page of DVD menu.



1. Capture Image

Touch to capture the current playing image and store into memory for background or screen saver.

3. Display

Touch to display the current playback information on the screen.

4. Repeat

Touch to repeat as CHAPTER-TITLE-ALL-REPEAT OFF when DVD playback.
 Touch to repeat as TRACK-ALL-REPEAT OFF when VCD/CD playback.
 Touch to repeat as REPEAT ONE-REPEAT ALL-REPEAT OFF when MP3 playback.

5. Direction Arrows Keyboard

Touch to display the [Direction Arrows Keyboard] on the left side of screen. Touch repeatedly to move the [Direction Arrows Keyboard] icons on the right side or left side of screen.



6. Menu

Touch to go to the menu of disc when playing DVD disc.

7. Switch

Touch to access the 1st page of DVD menu.

2. Setup

Touch to access the DVD SETUP menu.

Touch the [<] / [>] icons to switch the main menus as following:

General – Speaker – Dolby Digital – Preference – General

Touch the [^] / [v] icons to access the submenus from main menus.

Touch the [^] icon on the top submenu or [v] icon on the bottom of submenu to exit the submenus to main menus.

Touch the [^] / [v] icons to select the submenus as your need.

Touch the [>] or [ENTER] icons to access the items of submenus.

Touch the [<] icon to exit the items of submenus.

Touch the [v] / [^] icons to select the item you want to change.

Touch the [OK] icon to confirm the item you have selected and exit to the submenus.

Touch the [OK] icon on the submenu EXIT SETUP to exit the DVD SETUP Menu and save all settings.

General Setup Page



TV Display

Following options are available for the TV Display:

Normal / PS Normal / LB Wide

Angle Mark

Select ON or OFF.

OSD Language

Following options are available for the OSD Language:

English	French	German	Russia
Spanish	Dutch	Norwegian	Swedish
Danish	Italian	Portuguese	Hungarian
Russian	Polish	Korean	

SPDIF Output

Following options are available for the SPDIF Output:

SPDIF Off SPDIF / RAW SPDIF / PCM

Captions

Select ON or OFF.

Screen Saver

Select ON or OFF.

Last Memory

Select ON or OFF.

Speaker Setup Page



Downmix

Following options are available for the Downmix:
LT / RT Stereo Off

Dolby Digital Setup



Dynamic

Following options are available for the Dynamic:
FULL 6/8 4/8 2/8 OFF.

Preference Page

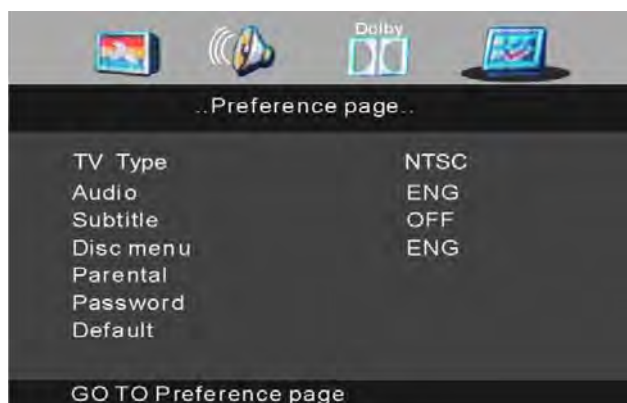

Audio

Following options are available for the Audio Language:

Danish Swedish Italian Portuguese
Polish Korean Russian Dutch

Subtitle

Following options are available for the Subtitle Language:

English French Spanish German
Danish Swedish Italian Portuguese
Polish Korean Russian Dutch Off

Disc Menu

Following options are available for the Disc Menu Language:

English French Spanish German
Danish Swedish Italian Portuguese
Polish Korean Russian Dutch

Parental

Following options are available for the Parental Ratings:

1 KID SAF 2 G 3 PG
4 PG 13 5 PGR 6 R
7 NC 17 8 ADULT 9 Off

The Parental Ratings could be changed after the correct password input.

Password

Setup the password for Parental Ratings change. The default password is 0000.

Default

The unit will restore all default settings by selecting this option.

IPOD OPERATIONS (Optional)

- 1, Touch the [IPOD] icon to switch IPOD Mode if iPod connected.
- 2, The unit will switch to IPOD Mode automatically if iPod connected.
- 3, The unit will switch to RADIO Mode automatically if iPod disconnected.



Music Page

Under the Music Page, it is not effective for the controller of iPod itself, use the keys of unit to control the operation and all operations are same as DVD Mode.

1. Current Source Indicator

Displays the source currently playing, touch to return the main menu.

2. Mute

Touch to switch off the sound; touch it again to resume to the previous volume level.

3. Next / 4. Previous

Touch to go to the next / pervious chapter, track or song.

5. Play/Pause

Touch to pause or resume the playback.

6. Video

Touch to access the video page.

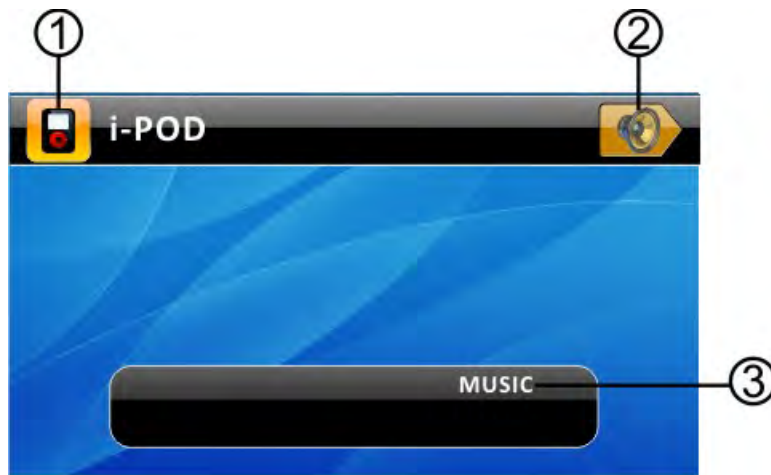

Video Page

Under the Video Page, use the controller of iPod itself to control all operations of iPod including play music, videos and view pictures.

1. Current Source Indicator

Displays the source currently playing, touch to return the main menu.

2. Mute

Touch to switch off the sound; touch it again to resume to the previous volume level.

3. Music

Touch the icon to access the music page.

NOTE:

The TV Output in iPod SETUP should be effective, and the pictures & videos could be displayed on the TFT monitor of unit.

SD OPERATIONS

1. Touch the [SD CARD] icon to access to SD Mode if SD / MMC Card inserted.
2. The unit will switch to SD Mode automatically if SD / MMC Card connected.
3. When SD / MMC Card disconnected, the unit will switch to RADIO Mode automatically if there is no disc in the unit; the unit will switch to DVD Mode automatically if there is a disc in the unit.
4. Under the SD Mode, all operations are same as DVD Mode.

USB OPERATIONS

1. Touch the icon [USB] to access the USB Mode if USB connected.
2. The unit will switch to USB Mode automatically if USB connected.
3. When USB disconnected, the unit will switch to RADIO Mode automatically if there is no disc in the unit; the unit will switch to DVD Mode automatically if there is a disc in the unit.
4. Under the USB Mode, all operations are same as DVD operations.

AV IN OPERATIONS

Touch the icon "AV IN" to enter the AV IN Mode:



1. Current Source Indicator

Displays the source currently playing, touch to return the main menu.

2. Mute

Touch to switch off the sound; touch it again to resume to the previous volume level.

NOTE:

There are 2 RCA Audio Inputs & 1 RCA Video Input for unit.

AUX IN OPERATIONS

Touch the icon "AUX IN" to enter the AUX IN Mode:



1. Current Source Indicator

Displays the source currently playing, touch to return the main menu.

2. Mute

Touch to switch off the sound; touch it again to resume to the previous volume level.

NAVI OPERATIONS (Optional)

Touch Screen Calibration

When 1st time to enter NAVI mode, you will see the calibration screen. Please touch the points from 1 to 5 by using a ballpoint pen or pencil.

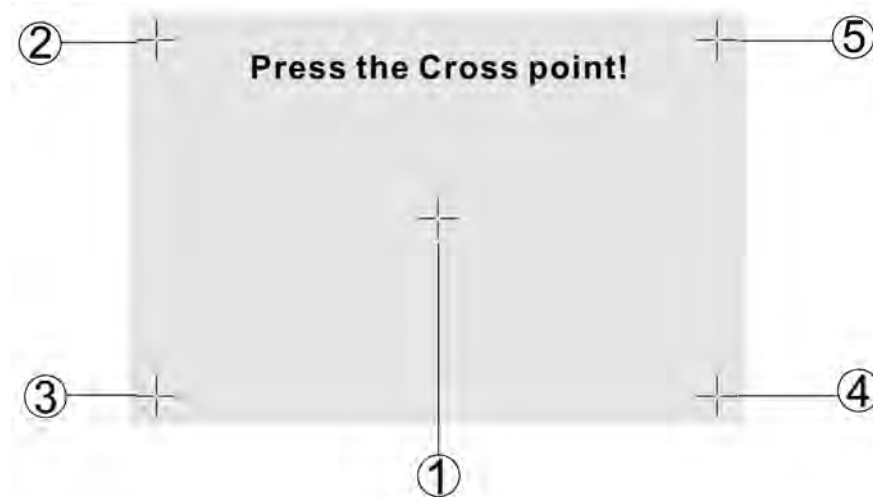

To verify the calibration, please touch the points from 1 to 5 again.

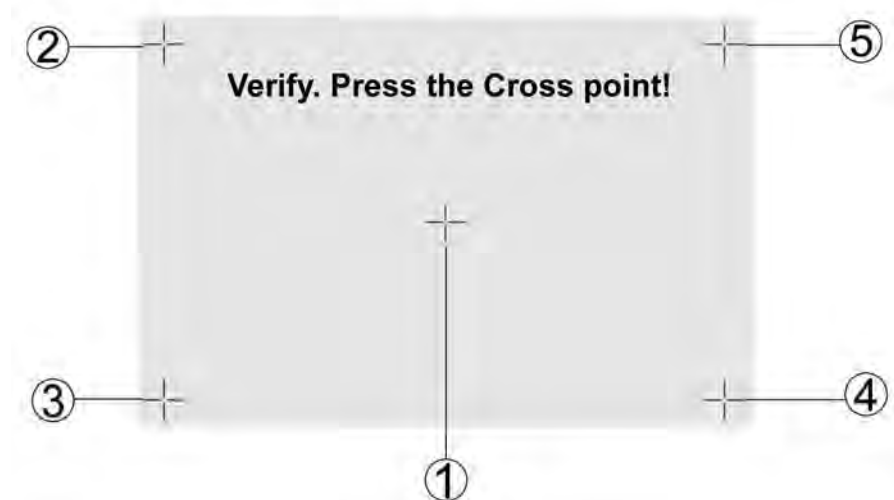

Then the following screen is displayed:

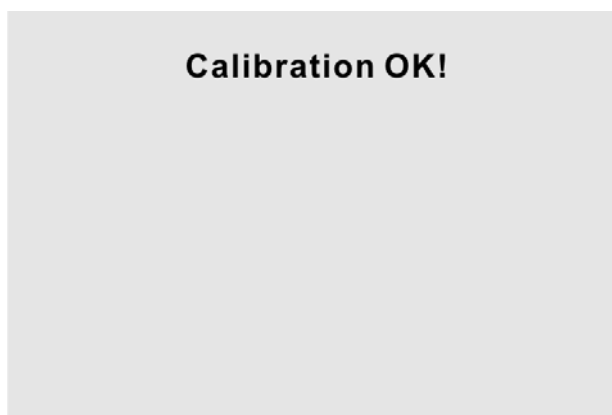

The Touch Screen is restored to their default positions. Touch anywhere of panel to finish the calibration and go to the following screen:

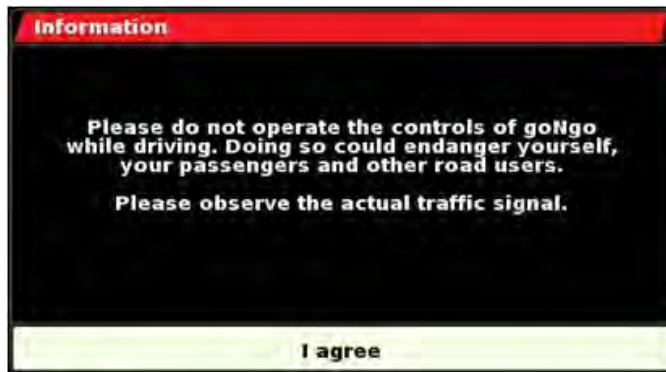

Read information and touch "I agree" button at the bottom of the screen, then enter the NAVI mode.

NOTE:

If change the NAVIbox to connect another unit, please take out the SD card from the NAVIbox and connect with computer, the following screen is displayed on computer:

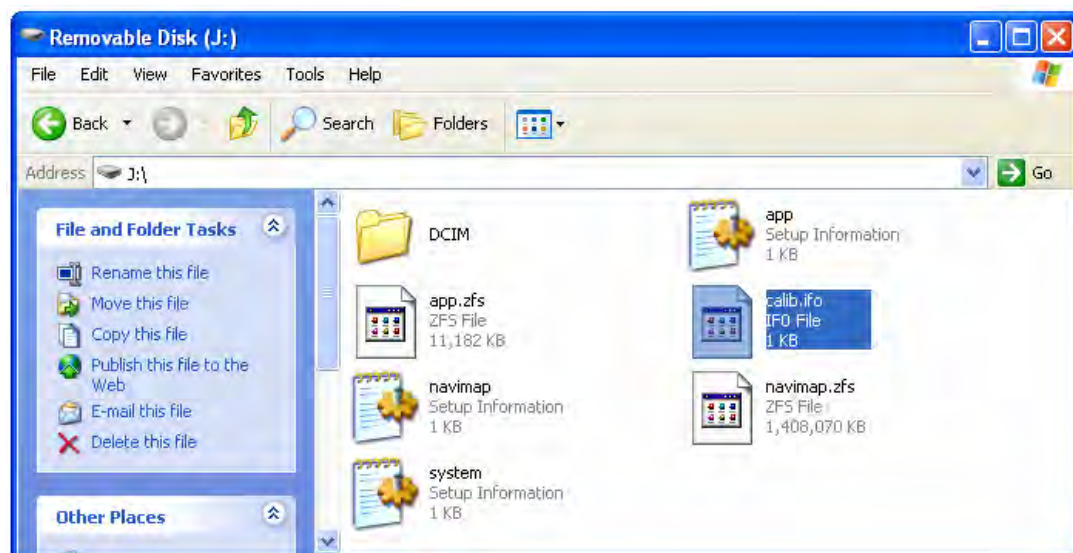

Delete the file "calib.ifo" only. Insert the SD card into NAVIbox again, and connect the NAVIbox with another unit.

Go to NAVI mode

Touch the icon “NAVI” to enter the NAVI Mode if NAVIBOX connected:

Following screen will be displayed:



Read information and touch “I agree” button at the bottom of the screen.

Enter the NAVI mode by main menu, the NAVI operations are effective only, all other processes are disable such as Radio, CD etc.

NOTE:

Under NAVI mode, please view all operations by Navigation Device NAVIBOX-1 User’s manual.

Quick Access Key [NAVI]

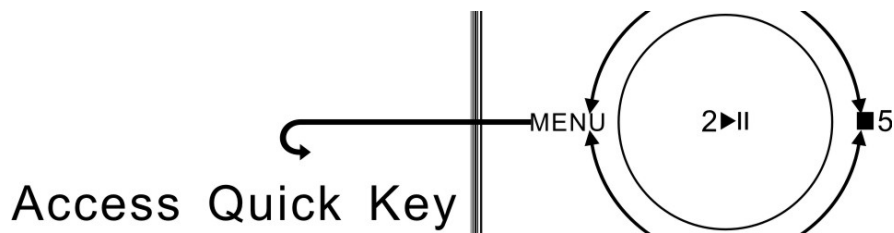

Under any working mode, hold on pressing the [MENU/NAVI] button to switch to NAVI mode; hold on pressing the [MENU/NAVI] button again to return the previous working mode. For example, under Radio mode, hold on pressing the [MENU/NAVI] button to switch to NAVI mode; hold on pressing the button again to quit the NAVI mode and return back the Radio mode.

Enter the NAVI mode by Quick Access Key, the previous working mode is still working on background. For example, under Radio mode, hold on pressing the [NAVI] button to switch to NAVI mode, and you can still listen to the radio stations. But when voice of Navigation comes, the radio will be interrupted until voice of Navigation ends.

No NAVIBOX Connection

Touch the "NAVI" icon to enter the following screen if the NAVIBOX not connected:



1. Current Source Indicator

Displays the source currently playing, touch to return the main menu.

2. Mute

Touch to switch off the sound; touch it again to resume to the previous volume level.

ATSC OPERATIONS (Optional)



1. Current Source Indicator

Displays the source currently playing, touch to return the main menu.

2. Mute

Touch to switch off the sound; touch it again to resume to the previous volume level.

3. Play/Pause

Touch to

4. Menu

Touch to display the menu.

5. Exit

Touch to exit the submenu or menu.

6. Direction Arrows Keyboard

Touch the arrows icons to select the item, touch the [ENTER] icon to confirm the selection.

NOTE:

Under ATSC mode, please view all operations by ATSC Device DTV-1 User's manual.

SYSTEM PARAMETERS SETUP

Touch the [SYSTEM] icon to enter the System Parameters Setup.

SCREEN SETUP

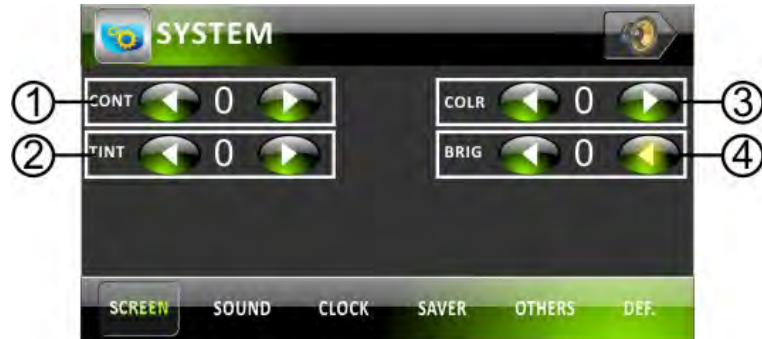

1. Contrast

Touch [UP] / [DOWN] icons to adjust the CONTRAST parameters (Range: -9 to 9);

2. Tint

Touch [UP] / [DOWN] icons to adjust the TINT parameters (Range: -9 to 9);

3. Color

Touch [UP] / [DOWN] icons to adjust the COLOR parameters (Range: -9 to 9);

4. Brightness

Touch [UP] / [DOWN] icons to adjust the BRIGHTNESS parameters (Range: -9 to 9);

SOUND SETUP



1. Treble

Touch [UP] / [DOWN] icons to adjust the TREBLE parameters (Range: -9 to 9);

2. Bass

Touch [UP] / [DOWN] icons to adjust the BASS parameters (Range: -9 to 9);

3. Sub-Woofer Frequency

Touch [UP] / [DOWN] icons to switch the SUB-WOOFER frequency as following:
OFF — 80Hz — 120Hz — 160Hz — OFF

4. Sub-Woofer Volume

Touch [UP] / [DOWN] icons to adjust the SUB-WOOFER volume parameter (Range: 0 to 15);

5. Buzzer

Touch to turn Buzzer on or off;

6. Balance / Fader

Touch [LEFT] / [RIGHT] icons to adjust the BALANCE parameters (Range: -9 to 9);

Touch [FRONT] / [REAR] icons to adjust FADER parameters (Range: -9 to 9);

7. X-Bass

Touch to turn X-Bass on or off;

CLOCK SETUP



1. Hour

Touch [UP] / [DOWN] icons to adjust the HOUR;

2. Minute

Touch [UP] / [DOWN] icons to adjust the MINUTE;

3. Time Display

Displays the time currently.

4. Time Mode

Touch to switch the time mode between 12-Hour and 24-Hour;

SAVER SETUP



1. Captured Images List

Touch [UP] / [DOWN] icons to select the image captured from DVD, SD card and USB.

2. Screen Saver Images List

Touch [UP] / [DOWN] icons to select the image of screen saver.

3. Desktop

Touch to set the selected image of captured images list as desktop image.

4. Del

Touch to delete the selected image of screen saver images list.

5. Add

Touch to add the selected image of captured images list as screen saver.

6. Screen Saver Time

Touch to adjust the screen saver time as following:
3MIN - 5MIN - NEVER - 10S - 20S - 30S - 60S - 3MIN

OTHERS SETUP



1. RADIO AREA

Touch [LEFT] / [RIGHT] icons to switch the Radio Area as following:
USA – JAPAN – ORIT – EUROPE – ASIA – USA

2. LOC

Touch [LEFT] / [RIGHT] icons to switch the LOC and DX.

3. EQ

Touch [LEFT] / [RIGHT] icons to switch the EQ as following:
USER – POP – CLASSIC – ROCK – JAZZ – USER

4. LOUD

Touch [LEFT] / [RIGHT] icons to turn Loud on or off;

DEFAULT

The unit will restore all default settings of System Parameters Setup.

SPECIFICATIONS

GENERAL

Supply Voltage	: 14.4V DC (11-16V allowed)
Load Impedance	: 4Ω per channel
Max Power Output	: 50W x 4
Bass 100Hz	: ≥ 10dB
Treble 10KHz	: ≥ 10dB
Dimensions (approx.)	: 183 x 188 x 60 mm (d/w/h)
Mounting (approx.)	: 160 x 178 x 50 mm (d/w/h)

FM TUNER

Frequency Range	: 87.5 – 108 MHz (Europe/Asia) 87.5 – 107.9 MHz (USA)
IF	: 10.7 MHz
Usable Sensitivity	: ≤ 15dBuV
Stereo Separation	: ≥ 26dB (1 KHz)
Frequency Response	: 100-20000Hz

AM TUNER

Frequency Range	: 531 - 1602 KHz (Asia) 522 - 1620 KHz (Europe) 530 - 1710 KHz (USA)
IF	: 450 KHz
Usable Sensitivity	: ≤ 40dBuV

TV TUNER (Optional)

Frequency Range	NTSC : 55.25 MHz~855.25MHz PAL: 48.25 MHz~855.25MHz
-----------------	--

DVD PLAYER

Signal-to-noise Ratio	: ≥ 85dB (1 KHz)
Distortion	: ≤ 0.5%

NOTE:

Specifications and design are subject to modification without notice due to improvement in technology.

TROUBLE SHOOTING

If any of problem persists after checking the below list, Please consult your nearest service dealer. Never attempt to disassemble and repair unit personally.

Problem	Cause	Action
GENERAL		
Unit will not turn on (no power)	Yellow wire not connected or incorrect voltage Re wire not connected or incorrect voltage	Check connections for proper voltage(11-16vdc)
	Black wire not connected	Check connection to ground
	ACC Fuse blown or Car battery fuse blown	Install new fuse with correct rating
	Illegal operation	Press the RESET button
Unit has power (but no/low audio output)	Speaker wires not connected	Check connections at speakers
	One or more speaker wires touching each other or touching chassis ground	Insulate all bare speaker wires from each other and chassis ground
	Speakers damaged	Review wiring diagram and check
Poor sound quality or distortion	Speaker power rating not compatible with unit	Connect proper speakers
	Speaker is shorted	Check speaker wire contact
Unit resets itself when engine is off	Incorrect connection between ACC and Positive battery wire	Check wiring and correct
Unit blows fuse	Yellow or red wire touching chassis ground	Check for pinched wire
	Speaker wires touching chassis ground	Check for pinched wire
	Incorrect fuse rating	Use fuse with correct rating
Unit has audio (when in reverse)	Parking brake safety circuit not connected	Check connections at parking brake
	Parking brake not applied	Apply parking brake
Excessive skipping	Unit is not mounted correctly	Check mounting sleeve
	Physical defect in media	Check media for scratches
IR remote does not work	Dead battery	Replace battery
	Battery installed incorrectly	Remove battery and install correctly
TUNER		
Weak station searching	Auto antenna is not fully extended	Connect the auto antenna control cable properly
	Auto antenna not properly connected	Connect the auto antenna control cable properly
	LOCAL function is activated	Turn LOCAL function off

Problem	Cause	Action
TFT MONITOR		
No video display (when in reverse)	Reverse circuit not connected	Check connections at reverse lamp
	Vehicle is not in reverse	Select reverse gear
Front panel will not open/close	Front panel obstructed	Remove the obstruct and press OPEN to resume the monitor open/close sequence
Flashing image or interference appears on screen	DVD is not compatible with current TV system settings Image blurred, distorted, or dark	Change setup to accommodate disc
Prolonged image or improper height/width ratio display	Improper video signal connections	Check wiring and correct
	Improper aspect ratio setup	Use correct aspect ratio setting
Touch screen function disorder if the position is excursion	Under different condition, for example: temperature , humidity, tec.	Do touch screen calibrate
DISC		
Cannot insert disc	Disc already inside unit	Eject current disc and insert new one
DVD does not start playback	Disc is warped or scratched	Use disc in good condition
	Disc is dirty or wet	Clean disc with soft cloth
	Incompatible disc is used	Use compatible disc
	Disc rating exceeds Parental Lock rating limit	Change parental Lock settings to lower restriction
	Disc region code is not compatible with unit	Use disc with proper region code
	Disc is inserted upside down	Insert disc with label side up
Image blurred , distorted, or dark	Disc is illegally copied	Use original disc
No repeat or searching while playing VCD	PBC is on	Turn PBC off
Interruption occurred during MP3 playback	Disc is dirty or scratched	Clean disc or replace new disc
Bad Disc appears on display	Focus error	Press eject or RESET

DISC NOTES

- Disc formats supported by this player



Handling and Cleaning

- Dirty, dusty, scratched or warped discs will cause misoperation.
- Do not place stickers or make scratches on discs.
- Do not warp discs.
- A disc should always be kept in its case when not in use to prevent from damage.
- Do not place discs in the following places:
 1. Direct sunlight.
 2. Dirty, dusty and damp areas.
 3. High temperature places.
 4. On the seats or dashboard.

Disc Cleaning

Use a dry soft cloth to wipe the surface. If the disc is quite dirty, use a soft cloth slightly moist with isopropyl (rubbing) alcohol. Never use solvent such as benzene, thinner or conventional record cleaners which may mar the surface of the disc.

NOTE:

A disc may become somewhat scratched (although not enough to make it unusable) depending on your handling it in the condition of the usage environment. These scratches are not an indication of any problem with the player.

Repairing New Discs with Rough Spots

A new disc may have rough edges on its inside and outside edges. If a disc with rough edges is used, the proper setting will not be performed and the player will not play the disc. Therefore, remove the rough edges in advance by using a ballpoint pen or pencil. To remove the rough edges, press the side of the pen or pencil against the inside and outside edges of the disc.

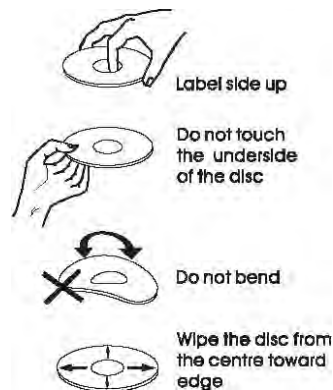
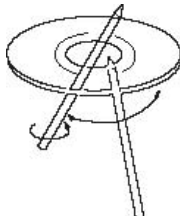

* *Manufactured under license from Dolby Laboratories.*

* *“Dolby” and the double-D symbol are trademarks of Dolby Laboratories.*