

2 Din Motorized 6.95" Wide Touch-Screen Monitor

AM/FM Receiver, DVD Player, USB, SD Card, MP4, iPod Connection

Operating Manual

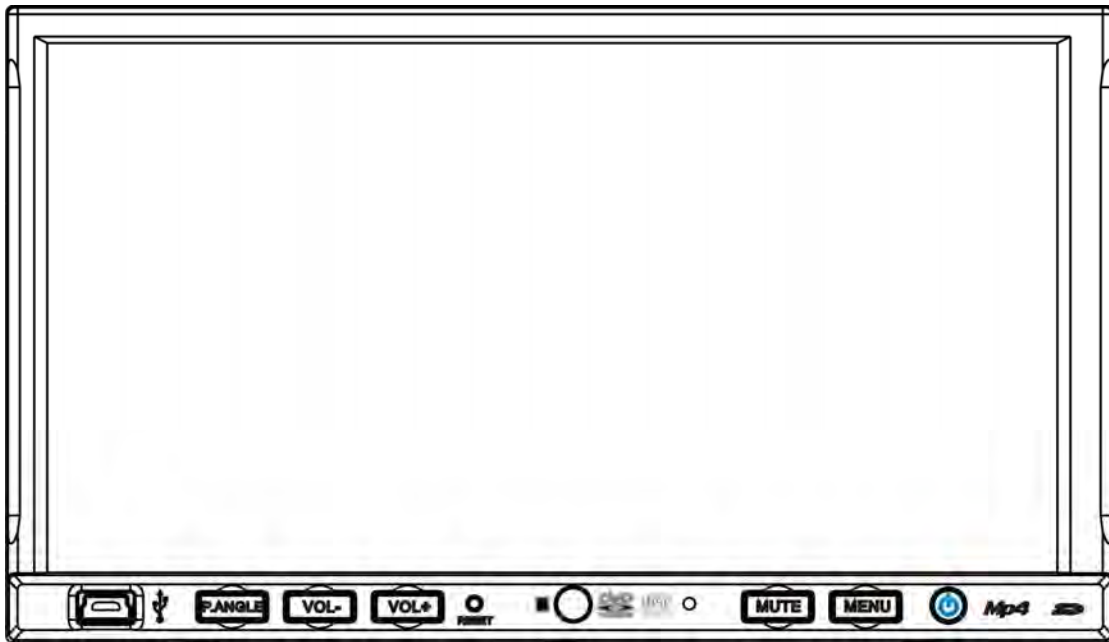

TABLE OF CONTENTS

Safety Information	2
Features	3
Accessories.....	4
Unit Installation.....	5
Unit Removal	7
Wire Connection	8
Front Panel	9
Rear Panel	12
Remote Control	13
Touch Screen Operations.	17
Touch Screen Calibrate	17
Main Menu	18
Radio Operations	19
DVD Operations	22
USB Operations	24
SD CARD Operations	24
iPod Operations	25
AV IN 1 Operations	27
AV IN 2 Operations	28
CDC Operations	29
System Setup	31
DVD Setup Menu.....	35
Trouble Shooting.....	40
Specifications	42
Disc Notes	43

SAFETY INFORMATION

Please read the manual carefully before operating this unit and keep it for future reference.

CAUTION: This unit is a class 1 laser product. To prevent direct exposure to the laser system, do not open the unit. The laser beam may hurt your eyes. If the unit requires adjustments, contact an authorized service centre.

USE THIS PRODUCT SAFELY

Be sure you fully understand the following safety information:

When driving

Keep the unit at an appropriate sound level. Driving with the sound at a level preventing you from hearing sounds outside and around the car may cause an accident.

When cleaning

Do not expose the product to water or excessive moisture. This could cause short circuit, fire or other severe damage.

When parked

Parking in direct sunlight can result in very high temperature levels inside your car. Let the interior and unit cool down before switching the unit on.

NOTE:

Do not use and store the player in dusty, hot or humid environment.

FUSE REPLACEMENT – WARNING!



Never replace any fuse with one of a higher value than the fuse supplied with your unit. Using a higher current rated fuse may cause damage to your unit and/or electrical wiring.

FEATURES

- Fully Motorized 4 Position Drop Screen With Last Angle Memory
- Electronic Touch Screen Functions Include DVD, Radio, USB, & MP-3/4
- DVD/DVD-RW/CD/CD-R/CD-RW/MP-3/MP-4/Divx
- All Functions Are Displayed On Screen Via OSD (Fourteen Languages)
- 30-Second Electronic Anti-shock Mechanism
- Accessory iPod Input Connection (Cable Not Included)
- USB Mini Input For MP-3 Music, Divx, Xvid & MP-4 Movies
- SD Card Slot For MP-3 Music Or MP-4 Movies (Memory Not Included)
- Front Panel A/V Input For Audio/Video MP-3/MP-4 Players
- IR Repeater Function For External Remote Eye
- Antenna Trigger Wire
- Amplifier Trigger Wire
- Brake Screen Safety Trigger
- AM/FM With 30 Pre-sets (18/FM – 12/AM)
- Auto Store Pre-set Scan
- 4-Channel High Power 50 x 4 Channels (Mosfet Power)
- Dual RCA Outputs (Front & Rear)
- Sub Woofer Selectable Frequency Outputs (80, 120, 160Hz)
- Variable Sub Woofer Volume Control
- 1-Auxiliary Video Input For Back-up Camera
- 1-RCA Video Output
- LO/DX And Stereo Mono Selector Switch
- Electronic (Bass, Treble, Volume, Balance, Fader)
- Pre-set EQ Functions (Rock, Pop, Classic Jazz, User)
- Digital Clock
- DVD, PAL/NTSC Selectable
- USA/Europe Frequency Stepping
- Resolution: 1440 x 234
- Panel Brightness: 450NIT
- ISO/ Double DIN
- Full Function Remote Control
- Last Position DVD Memory
- Improved Graphic User Interface

NOTE:

This user's manual is only for reference.

Modifying rights are reserved.

Specifications are subject to change without notice.

ACCESSORIES

1

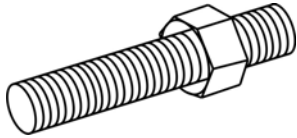

Bolt

2

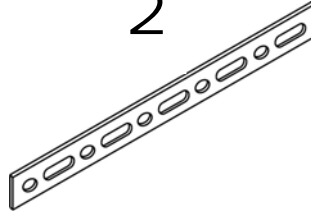

Steel Bar x 1

3



M5X5 Screws x 8

4

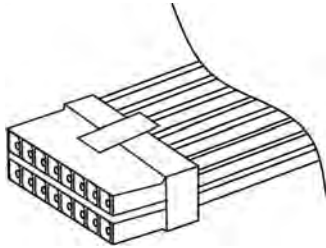

Connector Wire x 1

5

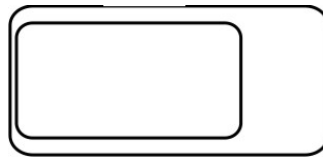

Remote Control x 1

6

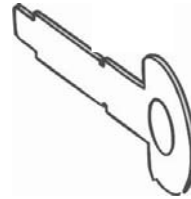

Keys x 2

7

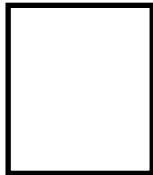

Operational Manual x 1

8

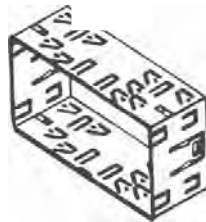

Mounting Sleeve x 1

9



USB Cable x 1

10



iPod Cable x 1
(option)

11



Trim Bezel x 1

12

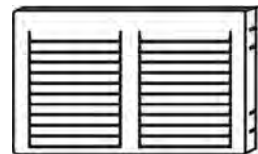

Air Vent Cover x 1

13

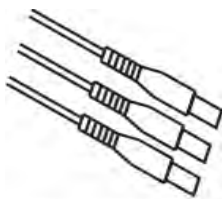

AV Cable x 1

UNIT INSTALLATION

1, connect the power cable with unit.

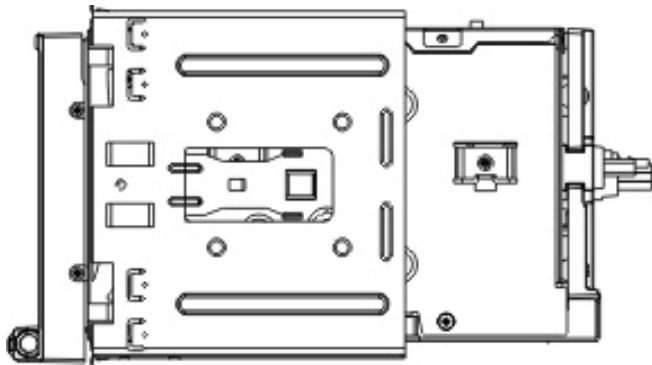

2, press the [P.ANGLE] button to slide down the front panel.

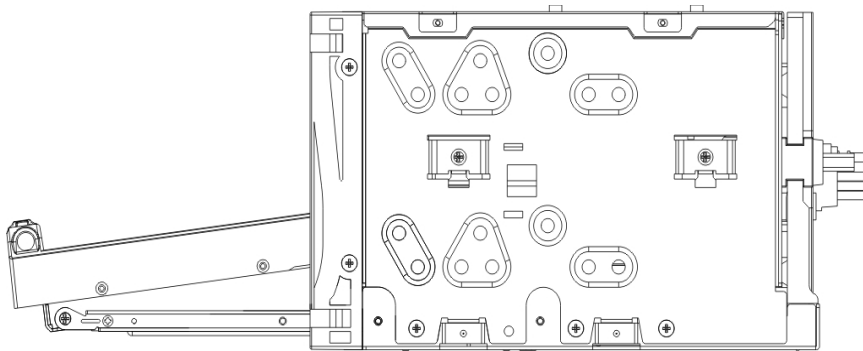

3, turn over the unit, loose the screws.

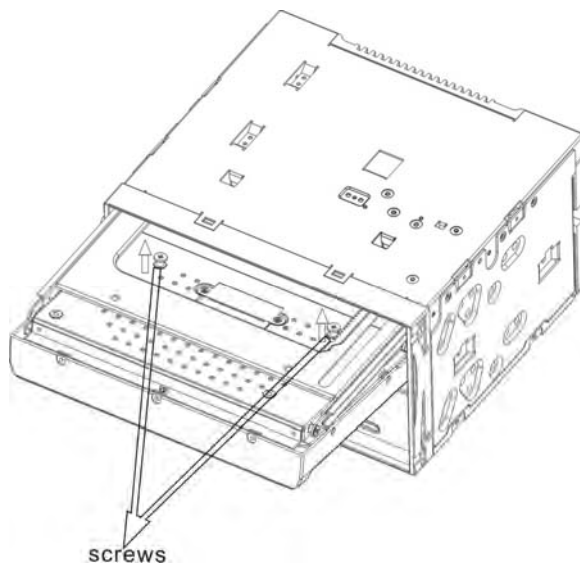

4, press the [P.ANGLE] button to close the front panel.

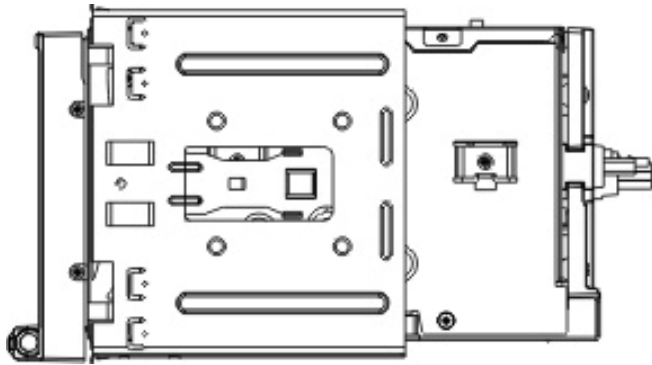

5, install the Mounting sleeve into the dashboard.

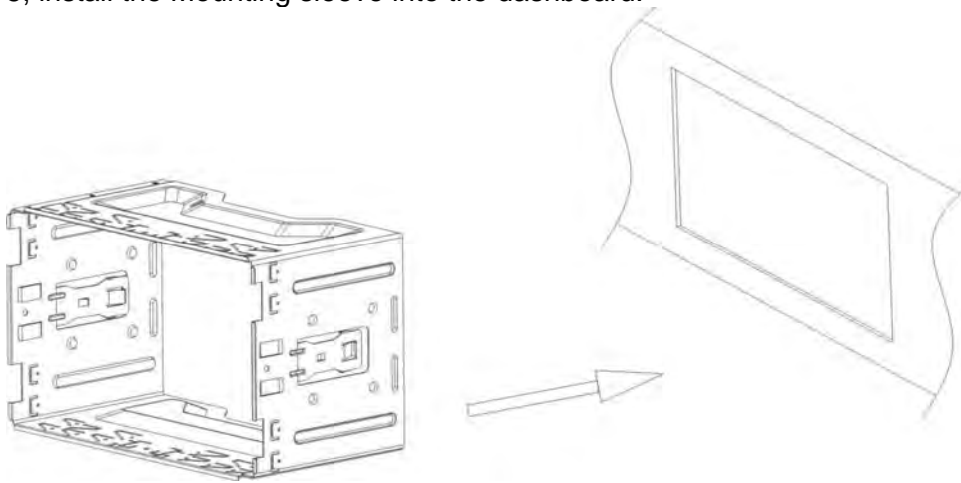

6, install the unit into the mounting sleeve.

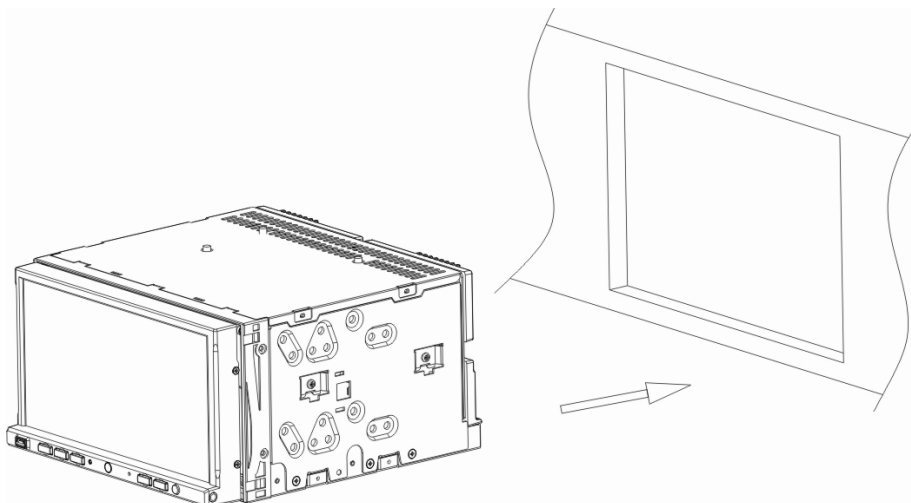

NOTE:
Screws are useful to protection during shipment.

UNIT REMOVAL

Insert the keys supplied with the unit on both sides (as illustrated) as this will release the internal locks so you can slide the unit out.

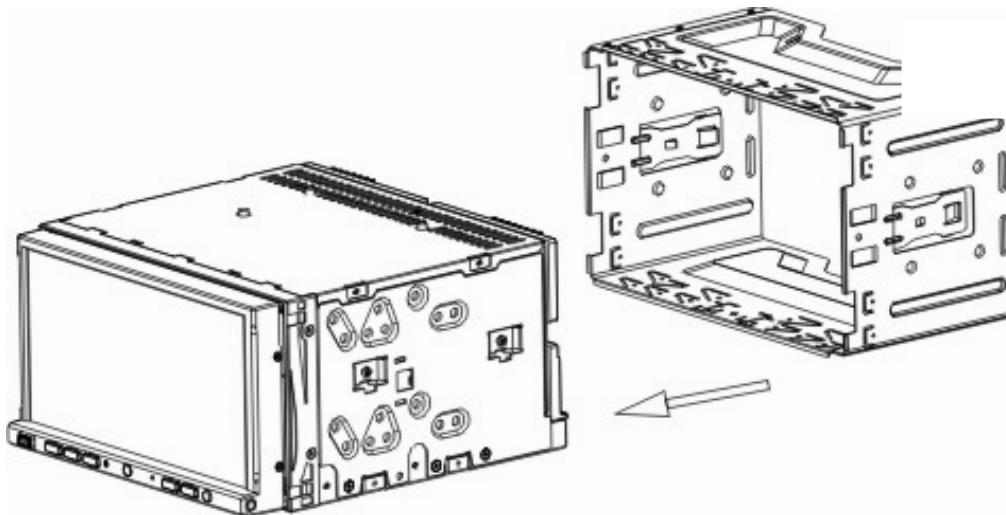
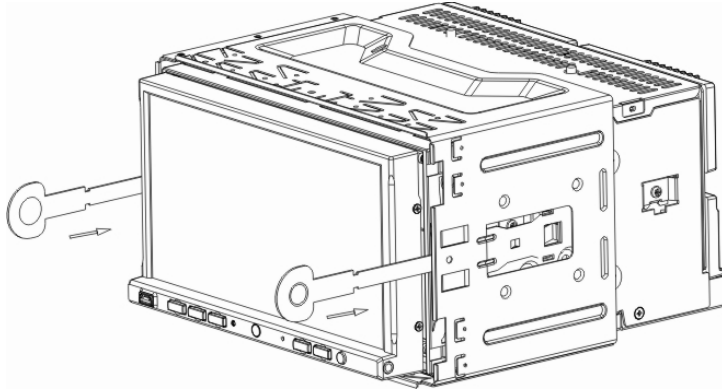

WIRE CONNECTION

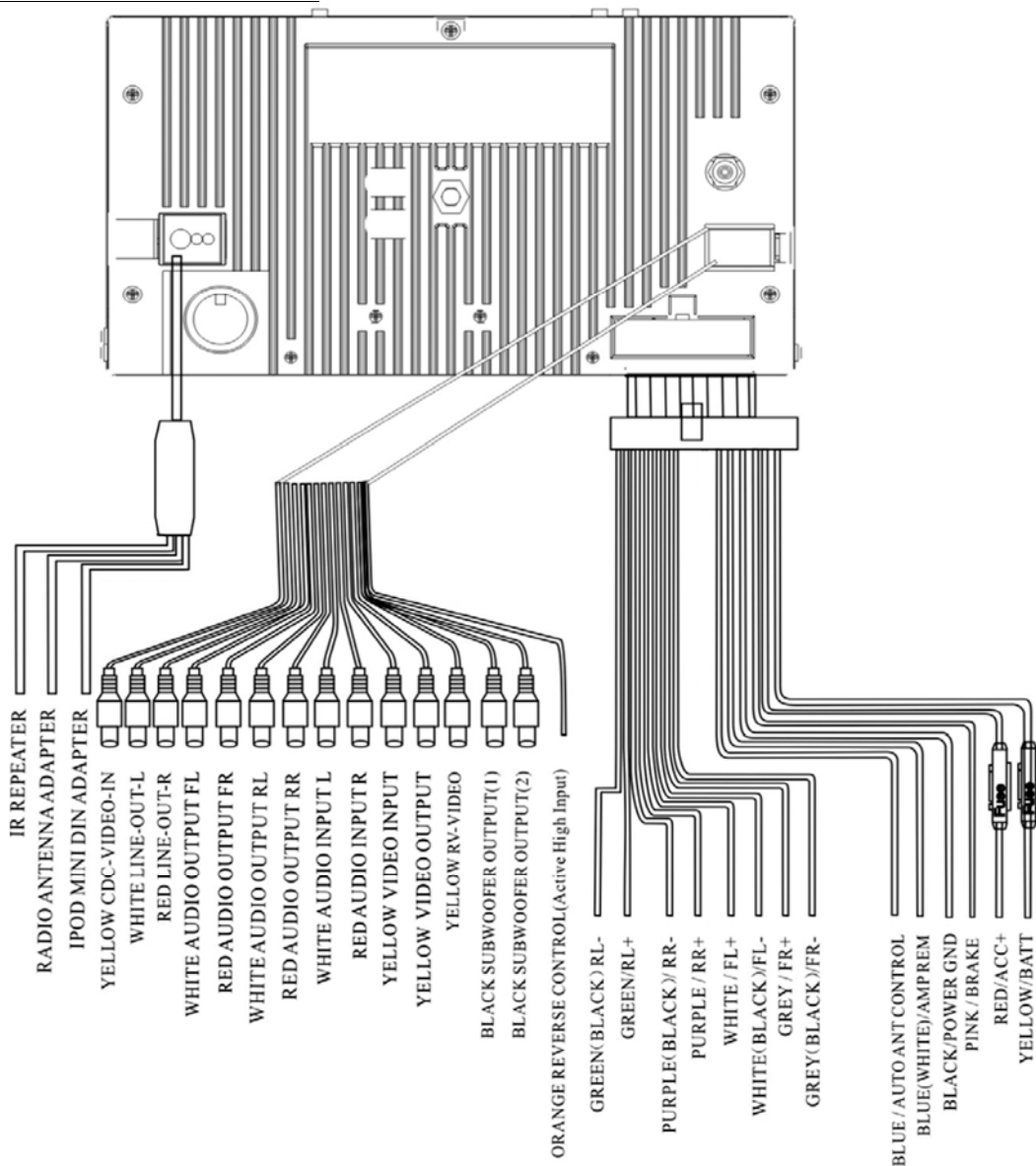

NOTE:

Brake Control

It is necessary to connect the Brake Control wire to the Hand-brake switch of the car. While driving, the TFT monitor will display the alarm picture (see as follows) in order to ensure the safety.

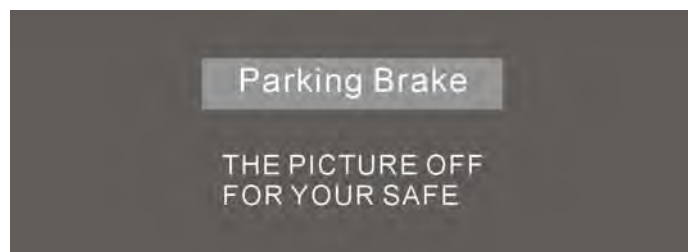

Under the Rear View Mode, the Brake Control function is no effective.

Auto Antenna Control

Connect the auto antenna control wire AUTO_ANT (see Wiring Diagram); the antenna will lift when the unit startup; it will descend when the unit turnoff.

FRONT PANEL

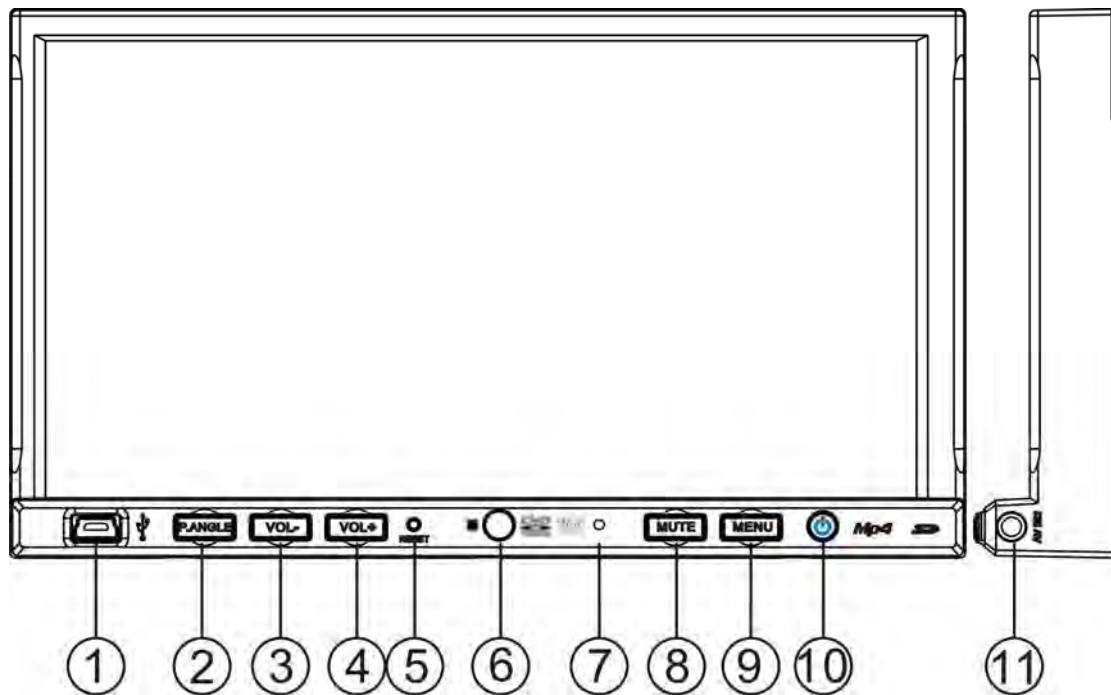

1. MINI USB
2. P.ANGLE
3. VOLUME -
4. VOLUME +

5. RESET
6. REMOTE
7. MIC
8. MUTE

9. MENU
10. POWER / SOURCE
11. AV IN 2

NOTE:

MIC is not effective for this unit, it is a common panel for Bluetooth function models.

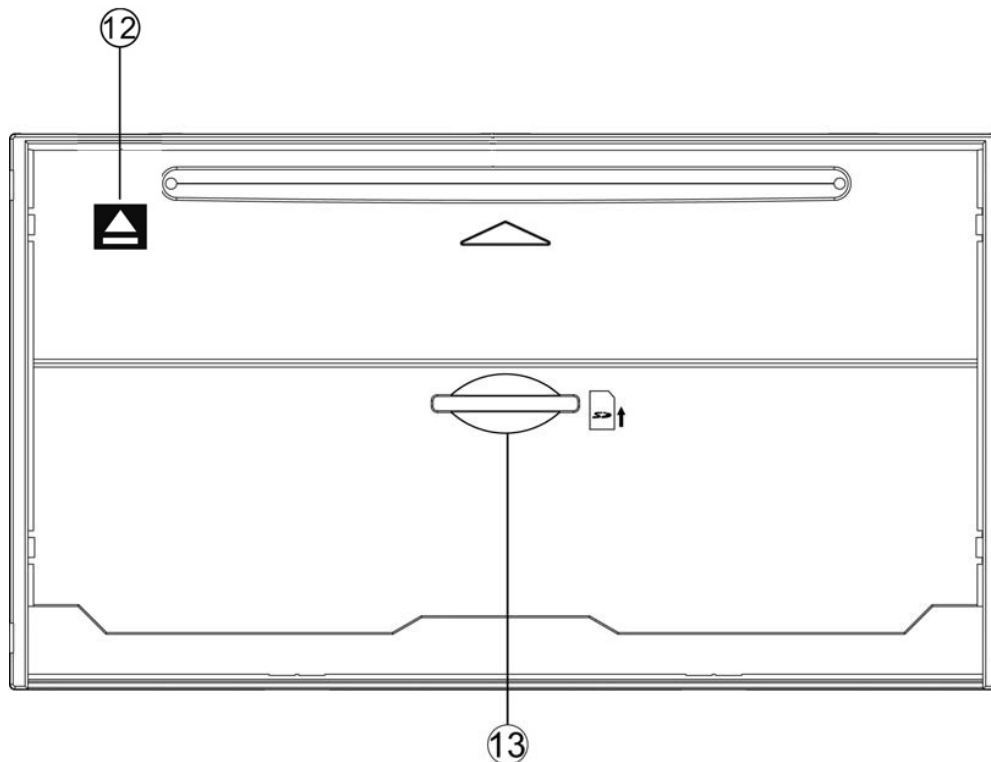

12. EJECT

13. SD CARD SLOT

1. MINI USB

The unit will be switched to DVD Mode automatically when USB connected, and play the songs, pictures, videos in USB.

2. [P.ANGLE/OPEN/CLOSE]

Press the button to open/close the monitor.

Hold pressing the button to adjust the angle of the front panel as following:

Angle 1 - Angle 2 - Angle 3 - Angle 4 - Angle 1

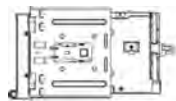

Angle 1

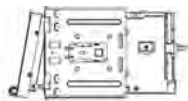

Angle 2

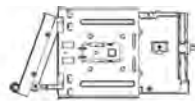

Angle 3

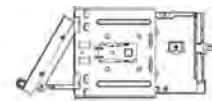

Angle 4

TFT Viewing Angle Calibrate

When "Power Off", press the buttons 1, 2, 3, [BAND/ENTER] of remote control;

Then the monitor should display 'TFT ANGLE CALIBRATE';

The motor and gear drives are now back to their factory positions.

3. [VOLUME-] / 4. [VOLUME+]

Press to increase / decrease the volume.

5. [RESET]

Press the button to switch back to all the original factory settings.

Keep in mind this will erase all your preset radio stations and any EQ settings you may have made and saved.

6. REMOTE

Infrared Remote Receiver

8. [MUTE]

Press the button to switch off the sound; press it again to resume to the previous volume level.

9. [MENU]

Press to return to the main menu.

10. [POWER/SOURCE]

Press the button to turn the unit ON;

Hold on pressing the button to turn the unit OFF.

When the unit is turned ON, press the button to toggle between the different modes as following:

RADIO – DVD – USB – SD – IPOD – CDC – AV IN 1 – AV IN 2 – RADIO

NOTE:

The unit could be switched to DVD Mode if disc inside;

The unit could be switched to USB Mode if Mini USB connected;

The unit could be switched to SD Mode if SD / MMC Card connected;

The unit could be switched to IPOD Mode if iPod connected;

11. AV IN 2

Connect an external audio/video device to this jack to watch to the device through your car video system.

12. [EJECT]

When flip down the front panel, press to eject / load a disc.

13. SD CARD SLOT

The unit will be switched to DVD Mode automatically when SD card inserted, and play the songs, pictures, videos in USB.

REAR PANEL

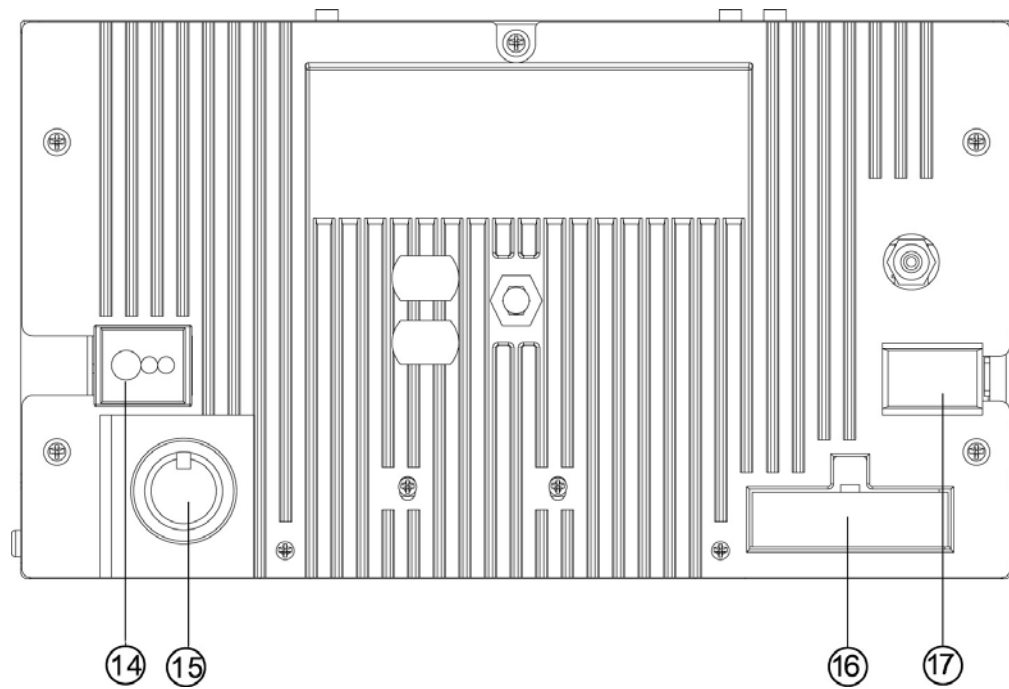

- 14. RADIO ANTENNA, IPOD MINI DIN & IR REPEATER ADAPTER**
- 15. CDC ADAPTER**
- 16. 16PIN SOCKET**
- 17. VIDEO AUDIO OUTPUT & INPUT**

REMOTE CONTROL

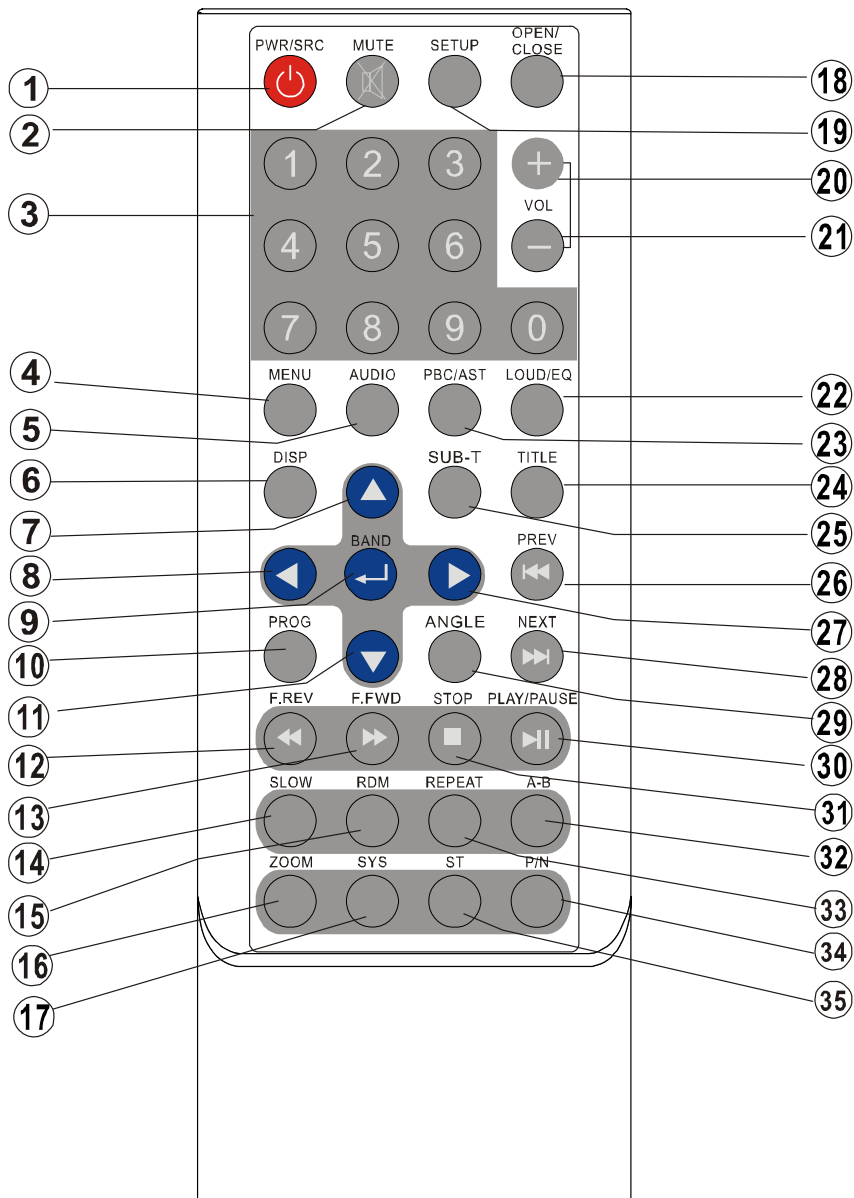

- 1. POWER / SOURCE
- 2. MUTE
- 3. NUMBER BUTTONS
- 4. MENU
- 5. AUDIO
- 6. DISPLAY
- 7. UP
- 8. LEFT
- 9. ENTER / BAND
- 10. PROGRAM
- 11. DOWN
- 12. F.REV

- 13. F.FWD
- 14. SLOW
- 15. RANDOM
- 16. ZOOM
- 17. SYSTEM
- 18. OPEN / CLOSE
- 19. SETUP
- 20. VOLUME +
- 21. VOLUME -
- 22. LOUD / EQ
- 23. PBC / AST
- 24. TITLE

- 25. SUBTITLE
- 26. PREVIOUS
- 27. RIGHT
- 28. NEXT
- 29. ANGLE
- 30. PLAY / PAUSE
- 31. STOP
- 32. A-B
- 33. REPEAT
- 34. PAL / NTSC
- 35. STEREO

1. [POWER/SOURCE]

Same functions as key on front panel.

2. [MUTE]

Press the [MUTE] button to switch off the sound; press it again to resume to the previous volume level.

3. [NUMBERS 0~9]

For 1~6, press these buttons to store the current radio station or recall the stored station under the Radio Mode.

For 0~9, press these buttons to select the tracks, and input the code.

4. [MENU]

Press to return to the boot menu when playing DVD disc.

Press to select PBC on / off when playing VCD disc.

5. [AUDIO]

Press to select dialogue language when playing DVD disc.

Press to select left audio channel, right audio channel or stereo when playing VCD disc.

6. [DISPLAY]

Press to display current playback information when playing DVD disc.

7. [^] / 8. [<] / 11. [v] / 27. [>] Direction Key

Under the DVD Setup menu:

Press the [v] / [^] buttons to move the cursor upward / downward to select item.

Press the [<] / [>] buttons to move the cursor leftward / rightward to select item.

Under RADIO Mode:

Press the [<] / [>] buttons to switch the stored stations.

Hold on pressing the [<] / [>] buttons to fast seeking the next available channel by decreasing / increasing the tuning frequency; seeking will stop by pressing any button.

Press the [v] / [^] buttons to decrease / increase the frequency step by step.

Hold on pressing the [v] / [^] buttons to fast seeking by decreasing / increasing the tuning frequency; seeking will stop when loose the button.

9. [BAND/ENTER]

In RADIO mode, press the [BAND] button to switch the wave band as following:

FM1 – FM2 - FM3 - AM1- AM2 - FM1

In DVD mode, press the [ENTER] button to confirm the Setup Menu.

10. [PROGRAM]

Press to enter / exit the PROGRAM Function when playing the VCD, CD, MP3 disc.

12. [F.REV]

Press to select fast reverse with different speed.

13. [F.FWD]

Press to select fast forward with different speed.

14. [SLOW]

Press to activate slow motion playback. (DVD Mode only)

15. [RANDOM]

Press to turn RAMDOM function on / off when playing CD / VCD disc (PBC OFF).

16. [ZOOM]

Press to magnify the picture display when play DVD, VCD disc.

17. [SYSTEM]

Press to enter / exit the System Parameter Setup menu.

18. [OPEN/CLOSE/P.ANGLE]

Same functions as key on front panel.

19. [SETUP]

Press to enter the DVD SETUP menu.

20. [VOL+] / 21. [VOL-]

Press to increase / decrease the volume.

22. [LOUD/EQ]

Press to adjust the EQ setting as following:

USER – POP – CLASSIC – ROCK – JAZZ – USER

Hold on pressing to turn the LOUD function on / off.

23. [PBC/AST]

Press to turn the PBC function on / off when playing VCD disc.

Hold on pressing to seek radio station / TV channel automatically under RADIO / TV Modes.

24. [TITLE]

Press to enter the title menu when playing DVD disc.

25. [SUB-T]

Press to select the subtitle language when playing DVD disc.

26. [PREVIOUS]

Press to skip to play the pervious track.

28. [NEXT]

Press to skip to play the next track.

29. [ANGLE]

Press the [ANGLE] button during playback to select different viewing angles with interactive DVD media.

30. [PLAY/PAUSE]

Press to pause the playback when playing; press again to continue playing.

31. [STOP]

Press to stop the playback.

32. [A-B]

Press to setup A-B repeat playing.

33. [REPEAT]

Press to select the chapter / title / disc to repeat playing.

34. [P/N]

Press the button to switch the video output (PAL/NTSC) when playing DVD disc.

35. [STEREO]

Press to turn the stereo on / off under Radio Mode.

REPLACING THE BATTERIES

If the remote control has no function or if the operating range reduced, replace the old battery with new one.

1. Pull out the battery holder. Follow the arrow 1 slide it to the right toward the battery while at the same time pull the battery holder away from the remote control.

2. Place the new battery. Place the new lithium battery with the (+) side up.

3. Push the holder back. Using the finger to push in the holder back until the locking sound is heard.

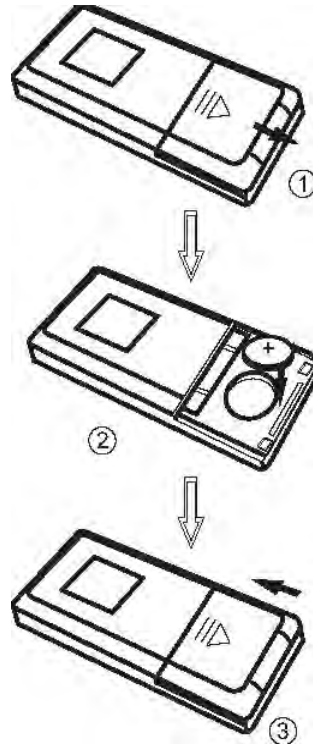

TOUCH SCREEN OPERATIONS

TOUCH SCREEN CALIBRATE

When "Power Off", press the buttons 1, 2, 3, 4, 5, [BAND] of remote control to enter the CALIBRATE page:

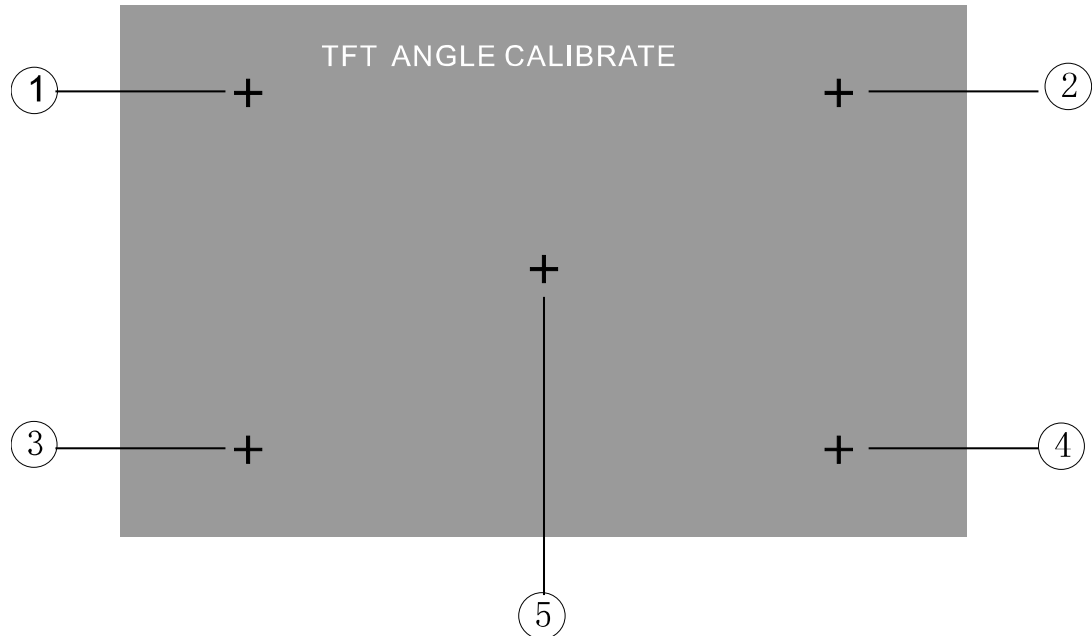

To touch the points from 1 to 5 until the points change to brighter by using a ballpoint pen or pencil.

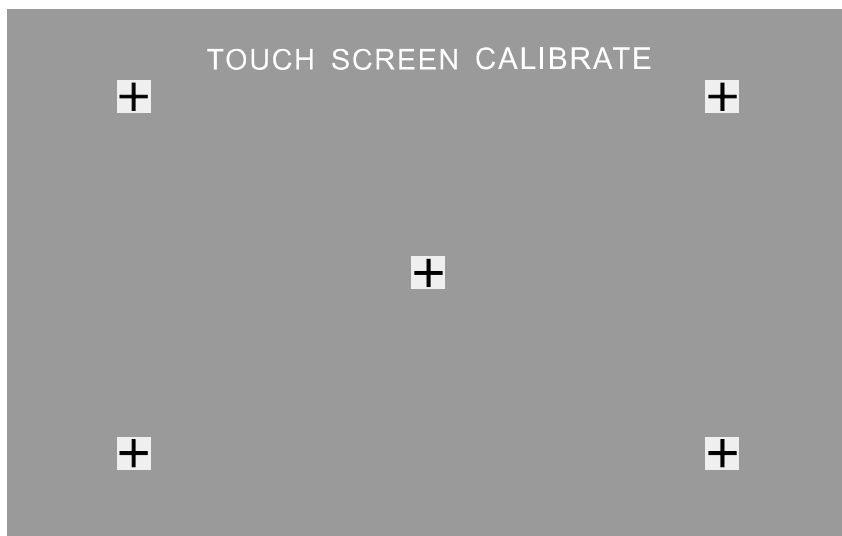

After all 5 points change to brighter, the unit would finish the CALIBRATE and power off again. Then the Touch Screen is restored to their default positions.

MAIN MENU



Touch the icon "MORE" to enter the 2nd page of main menu:

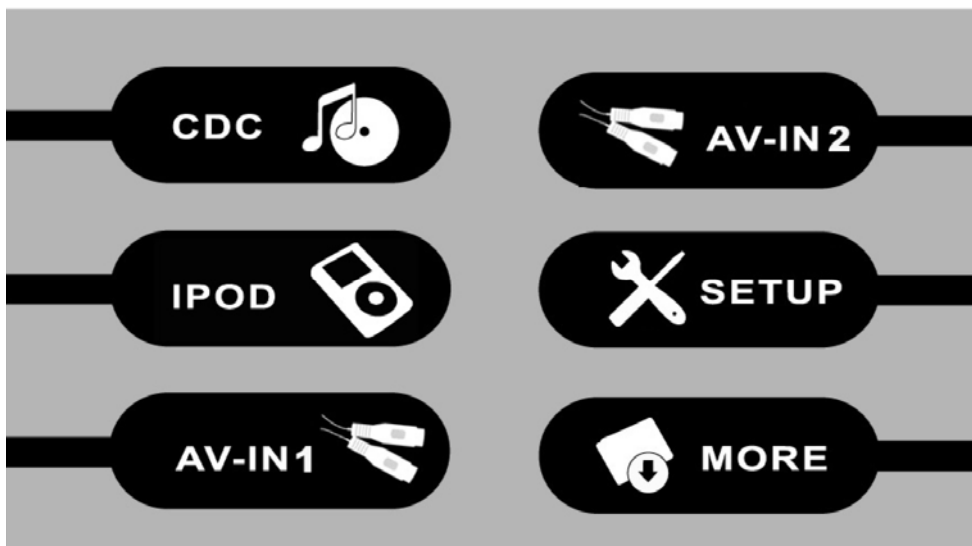

RADIO OPERATIONS

Touch the icon "RADIO" to enter the **1st operation page of RADIO Mode:**

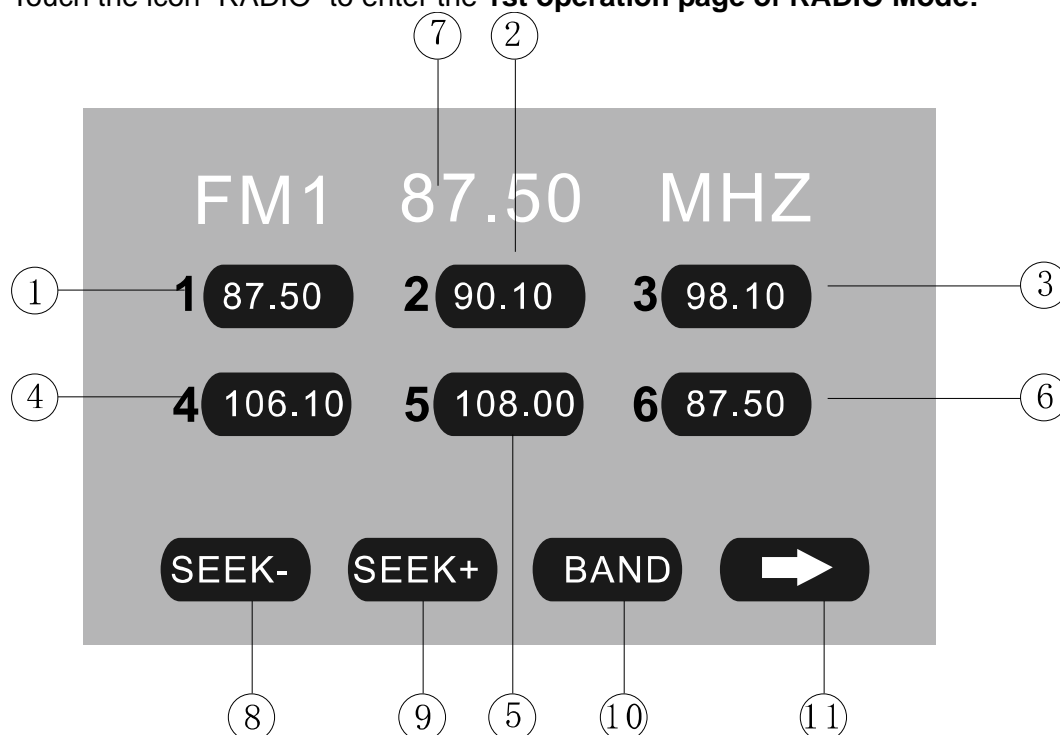

1~6. STORED CHANNEL

Manual Store Radio Station

Hold on touching the icon, you can store current radio frequency to the stored channel. For example, the current frequency is 98.5MHZ, by hold on touching the icon 1, you can store the radio station of 98.5MHZ to the channel 1.

After manual store radio station, the former stored stations will be instead.

In each wave band, the number icons 1 to 6 represent the stored radio stations.

To hold on pressing the number buttons 1~6 of remote control performs same operation.

Recall a Preset Station

Touch the icon 1~6 to recall the corresponding stored station in M1~M6 channels. To press the number buttons 1~6 of remote control performs same operation.

7. FREQUENCY

8. SEEK - / 9. SEEK +

Touch the icon to seek the next available channel by increasing / decreasing the tuning frequency.

Press any button to stop seeking.

Seeking will stop automatically when seek an available channel then play this station. The unit will stop on the beginning frequency if no available station after seeking one cycle.

To hold on pressing [>] / [<] buttons of remote control performs same operation.

10. BAND

Touch the icon to switch the FM/AM wave band as following:

FM1 - FM2 - FM3 - AM1- AM2 - FM1

To press the [BAND] button of panel or remote control performs same operation.

11. NEXT PAGE

Touch the icon to enter the 2nd page of RADIO Mode:

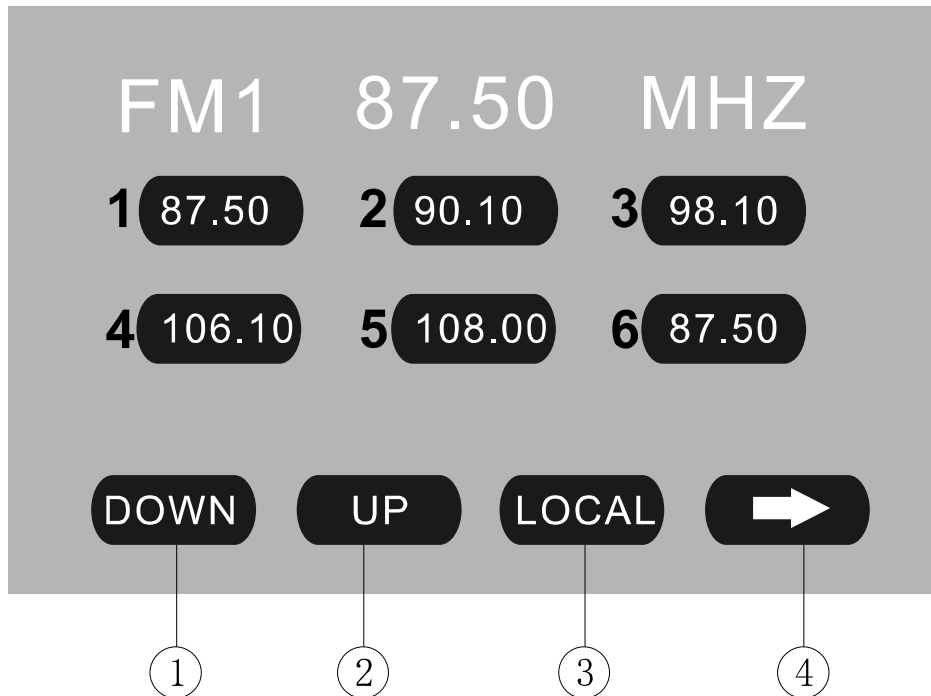

1. DOWN / 2. UP

Touch the icons to adjust the frequency downward / upward by step decreasing / increasing.

Hold on touching the icons has same function with [SEEK-] / [SEEK+].

To press the [∇] / [∧] buttons of remote control performs same operation.

3. LOCAL: ON / OFF

When you are using the local searching function of LOCAL, you can only receive the radio station with strong enough signals and fine state.

4. NEXT PAGE

Touch the icon to enter the 3rd page of RADIO Mode:

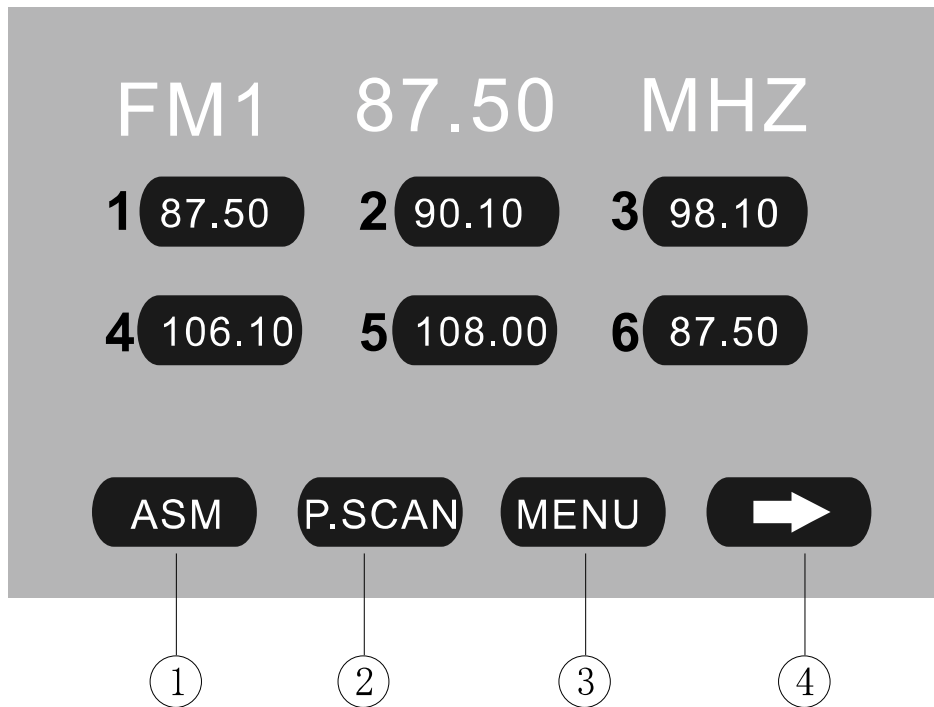

1. ASM

Seeking and store the stations

1. Hold on touching the icon to seek stations with the strongest signal from the lowest frequency point in the entire wave bands; press any button to stop seeking. After seeking, the former stored stations will be instead.
2. Store the received effective radio frequency to the six stored channels M1~M6.
3. The unit will play the stations one by one for few seconds; press any button to stop playing.
4. It is independent for FM & AM frequency. There are 3 wave bands of FM1、FM2、FM3 & 2 wave bands of AM1、AM2, each can store 6 radio stations, totally 30 radio stations.
5. The unit will stop on the beginning frequency if no available station after seeking one cycle.
6. To press the [AST] button of panel or hold on pressing the [PBC/AST] button of remote control performs same operation.

2. P.SCAN

The unit will play the stored stations one by one for few seconds from FM1, FM2, FM3, AM1, AM2; press any button to stop playing.

3. MENU

Touch the icon to return the main menu.

4. NEXT PAGE

Touch the icon to enter the 1st page of RADIO Mode.

DVD OPERATIONS

Touch the icon “DVD” to enter the DVD Mode if disc inside.

The unit will switch to DVD Mode automatically if loading disc.

The unit will switch to RADIO Mode automatically if ejecting disc.

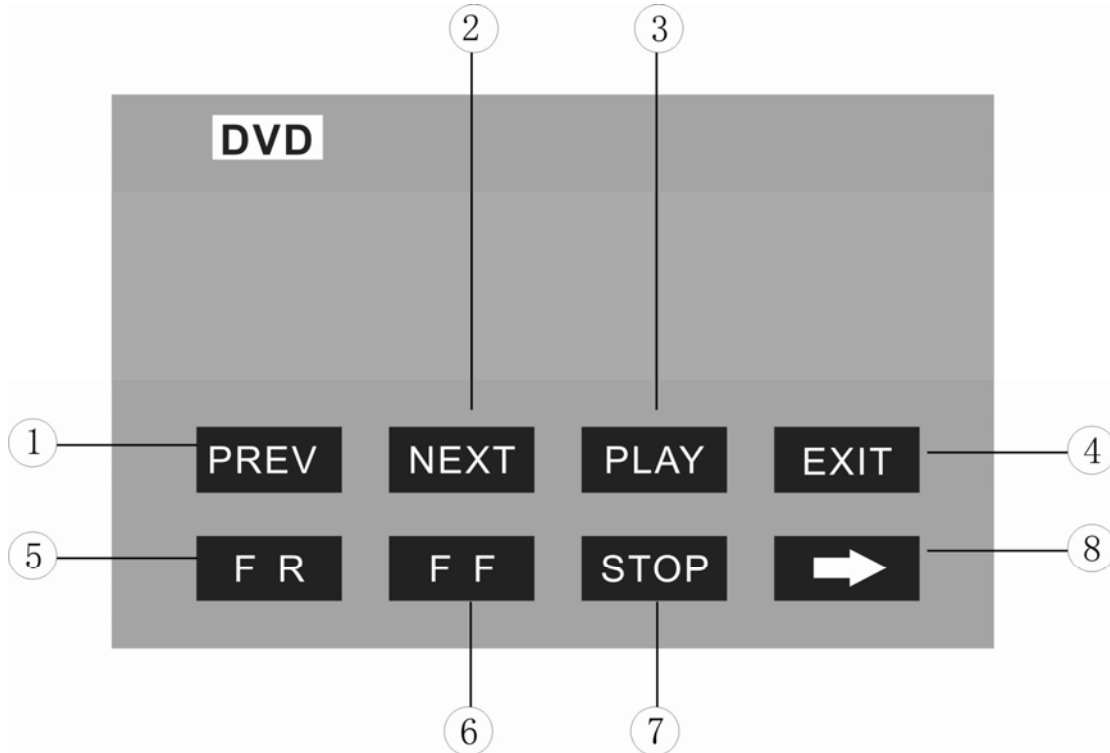

1. PREV / 2. NEXT

Touch the icon to go to the pervious / next chapter, track or song.

To press the [Previous] / [Next] buttons of panel or remote control performs same operation.

3. PLAY

Touch the icon to play or pause the disc.

To press the [PLAY/PAUSE] button of remote control performs the same operation.

4. EXIT

Touch the icon to exit the TOUCH ICONS display.

5. F.REV / 6. F.FWD

Touch the icon to select fast reverse / forward search. Touch the [PLAY] icon to resume to normal playback.

To press the [F.REV] / [F.FWD] buttons of remote control performs the same operation.

7. STOP

During movie playback, touch the icon once; the DVD player memorizes the location where you stopped (touch the [PLAY] icon to resume playing from the memorized location). If you touch the icon twice, the playback will start from the beginning of the disc when you touch the [PLAY] icon.

To press the [STOP] button of remote control performs the same operation.

8. NEXT PAGE

Touch the icon to enter the 2nd page of DVD Mode:

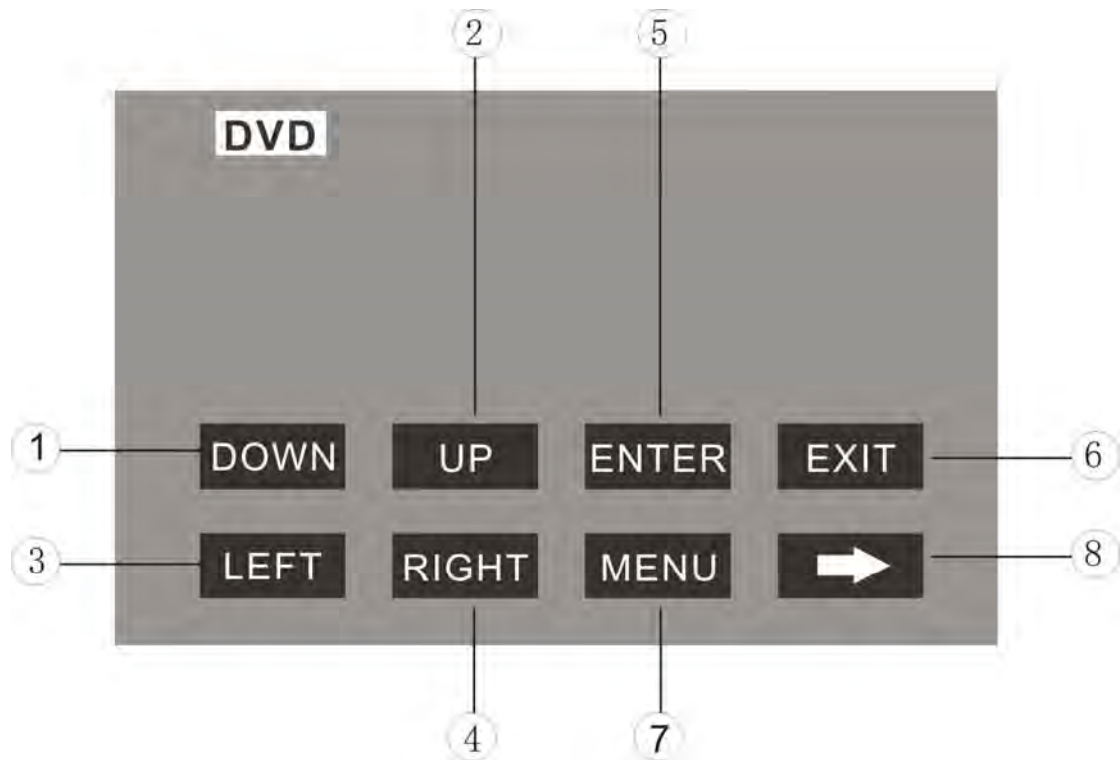

1~4. DOWN / UP / LEFT / RIGHT

Touch the direction icons (UP / DOWN / LEFT / RIGHT) to move the cursor to the selected item.

To press the direction buttons (UP / DOWN / LEFT / RIGHT arrow) of remote control performs same operation.

5. ENTER

Touch the icon to confirm the selection.

To press the [ENTER] button of remote control performs same operation.

6. EXIT

Touch the icon to exit the TOUCH ICONS display.

7. MENU

Touch the icon to return the main menu.

8. NEXT PAGE

Touch the icon to enter the 1st page of DVD Mode.

USB OPERATIONS

Touch the icon “USB” to enter the USB Mode if USB connected.

The unit will switch to USB Mode automatically if connecting USB.

When disconnecting USB, the unit will switch to RADIO Mode automatically if there is no disc in the unit; and the unit will switch to DVD Mode automatically if there is a disc inside.

Under USB Mode, all operations are same as DVD operations.

SD CARD OPERATIONS

Touch the icon “SD CARD” to enter the SD CARD Mode if SD card connected.

The unit will switch to SD CARD Mode automatically if connecting SD card.

When disconnecting SD card, the unit will switch to RADIO Mode automatically if there is no disc in the unit; and the unit will switch to DVD Mode automatically if there is a disc inside.

Under SD CARD Mode, all operations are same as DVD operations.

IPOD OPERATIONS

Touch the icon "IPOD" to enter the IPOD Mode if iPod connected.
The unit will switch to IPOD Mode automatically if connecting iPod.
The unit will switch to RADIO Mode automatically if disconnecting iPod.

NOTE:

It is available for iPod operations with an additional iPod cable which is optional accessory.

Music Operation

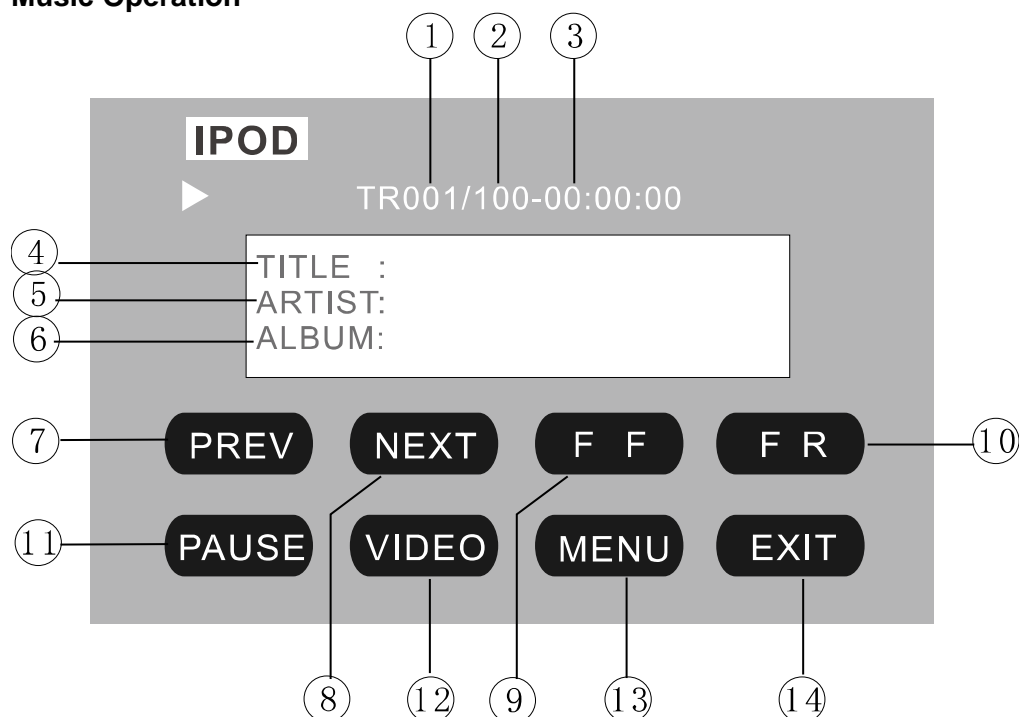

1. The Number of Playing Song
2. The Total Songs in Play List
3. The Playing Time
4. The Name of Playing Song
5. The Name of Artist
6. The Name of Album
7. PREV / 8. NEXT

Touch the icon to go to the pervious / next chapter, track or song.

To press the [PREVIOUS] / [NEXT] buttons of panel or remote control performs same operation.

9. F.REV / 10. F.FWD

Touch the icon to select fast reverse / forward search. Touch the [PLAY] to resume to normal playback.

To press the [F.REV] / [F.FWD] buttons of remote control performs the same operation.

11. PLAY / PAUSE

Touch the icon to play or pause the disc.

To press the [PLAY/PAUSE] button of panel or remote control performs the same operation.

12. VIDEO

Touch the icon to switch to the VIDEO operation.

13. MENU

Touch the icon to return the main menu.

14. EXIT

Touch the icon to exit the TOUCH ICONS display.

Video Operation

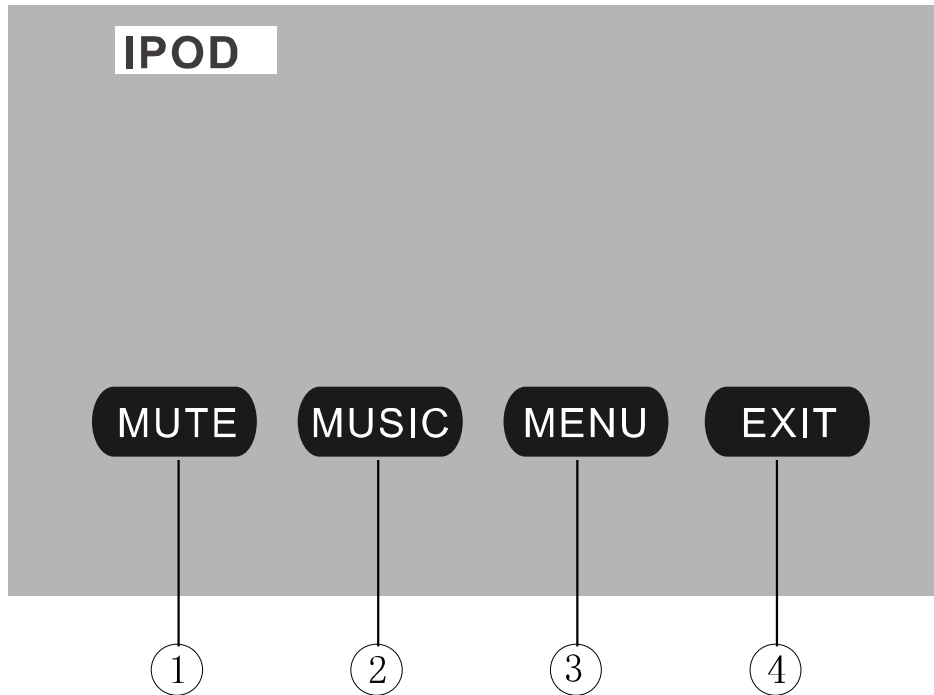

1. MUTE

Touch the icon to switch off the sound; touch it again to resume to the previous volume level.

2. MUSIC

Touch the icon to switch to the MUSIC operation.

3. MENU

Touch the icon to return the main menu.

4. EXIT

Touch the icon to exit the TOUCH ICONS display.

AV IN 1 OPERATIONS

Touch the icon "AV IN 1" to enter the AV IN 1 Mode:

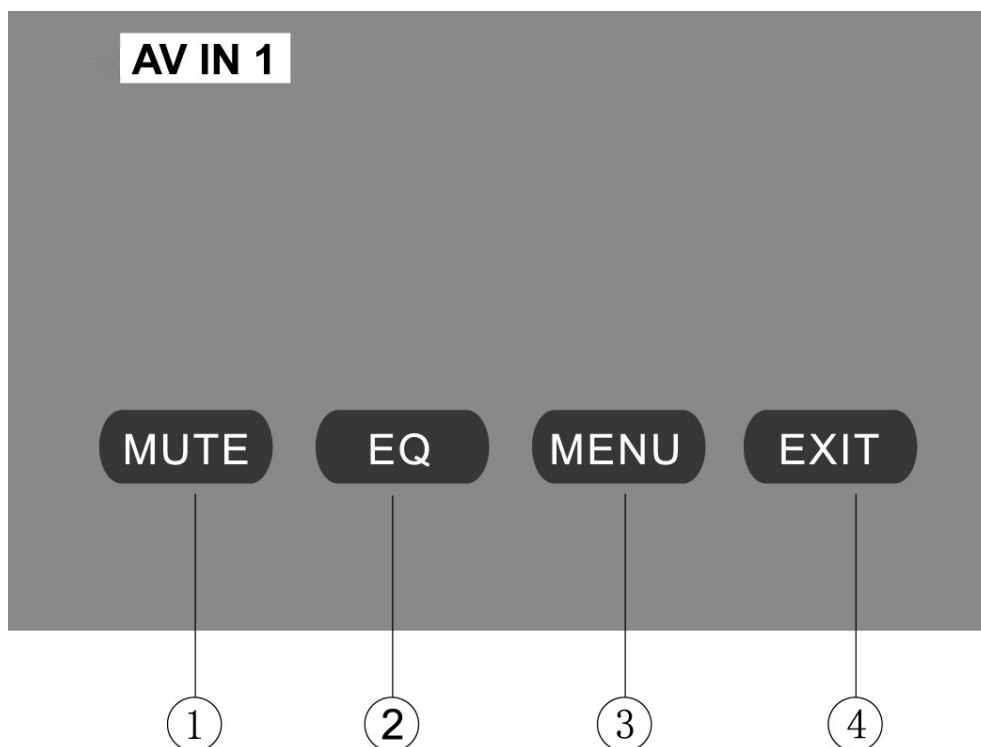

1. MUTE

Touch the icon to switch off the sound; touch it again to resume to the previous volume level.

2. EQ

The user can set to adjust the audio output to your preference:
USER – POP – CLASSIC – ROCK – JAZZ – USER

3. MENU

Touch the icon to return the main menu.

4. EXIT

Touch the icon to exit the TOUCH ICONS display.

NOTE:

AV IN 1 is for the RCA audio (L/R) & video input on rear panel of unit.

AV IN 2 OPERATIONS

Touch the icon “AV IN 2” to enter the AV IN 2 Mode:

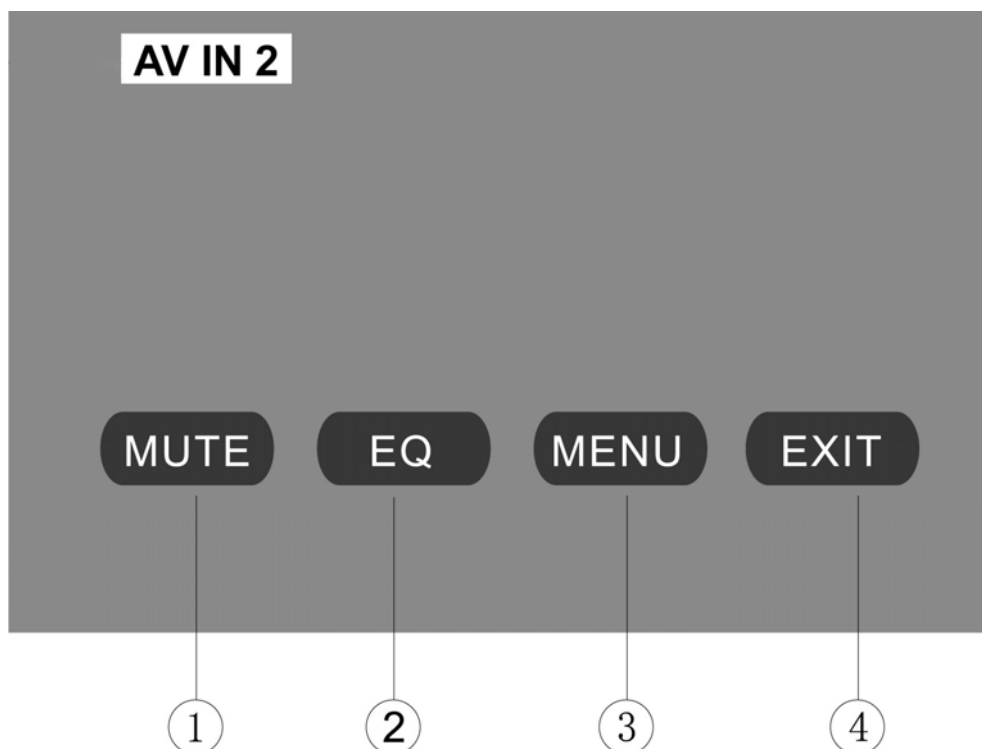

1. MUTE

Touch the icon to switch off the sound; touch it again to resume to the previous volume level.

2. EQ

The user can set to adjust the audio output to your preference:
USER – POP – CLASSIC – ROCK – JAZZ – USER

3. MENU

Touch the icon to return the main menu.

4. EXIT

Touch the icon to exit the TOUCH ICONS display.

NOTE:

AV IN 2 is for the audio (L/R) & video input jack on the right side of front panel (see item 11 in page 9). Connect an external audio/video device to AV IN 2 jack to listen to the device through your car speakers.

CDC OPERATIONS

Touch the icon "CDC" to enter the CDC Mode if CD/DVD changer connected:

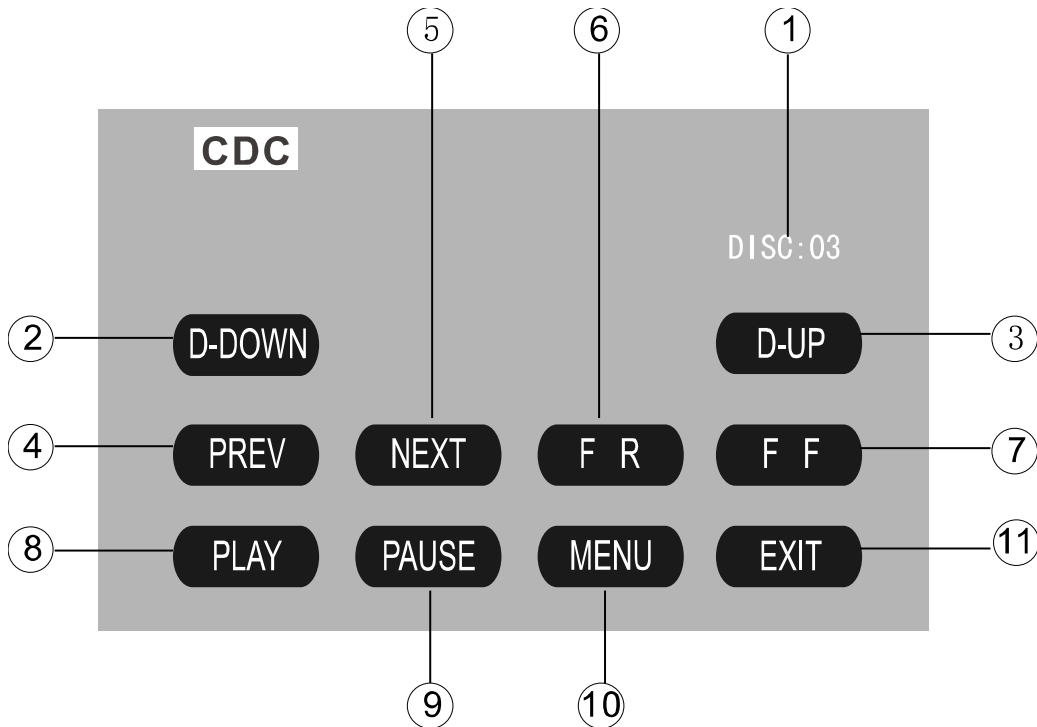

1. The playing DISC number

2. D-DOWN / **3.** D-UP

Touch the icon to change the next / previous disc to play.

4. PREV / **5.** NEXT

Touch the icon to go to the pervious / next chapter, track or song.

To press the [PREVIOUS] / [NEXT] buttons of panel or remote control performs same operation.

6. F.REV / **7.** F.FWD

Touch the icon to select fast reverse / forward search. Touch the [PLAY] icon to resume to normal playback.

To press the [F.REV] / [F.FWD] buttons of panel or remote control performs the same operation.

8. PLAY / **9.** PAUSE

Touch the icon to play or pause the disc.

To press the [PLAY/PAUSE] button of panel or remote control performs the same operation.

10. MENU

Touch the icon to return the main menu.

11. EXIT

Touch the icon to exit the TOUCH ICONS display.

NOTE:

Touch the “CDC” icon to enter the following page if the CD/DVD changer not connected.

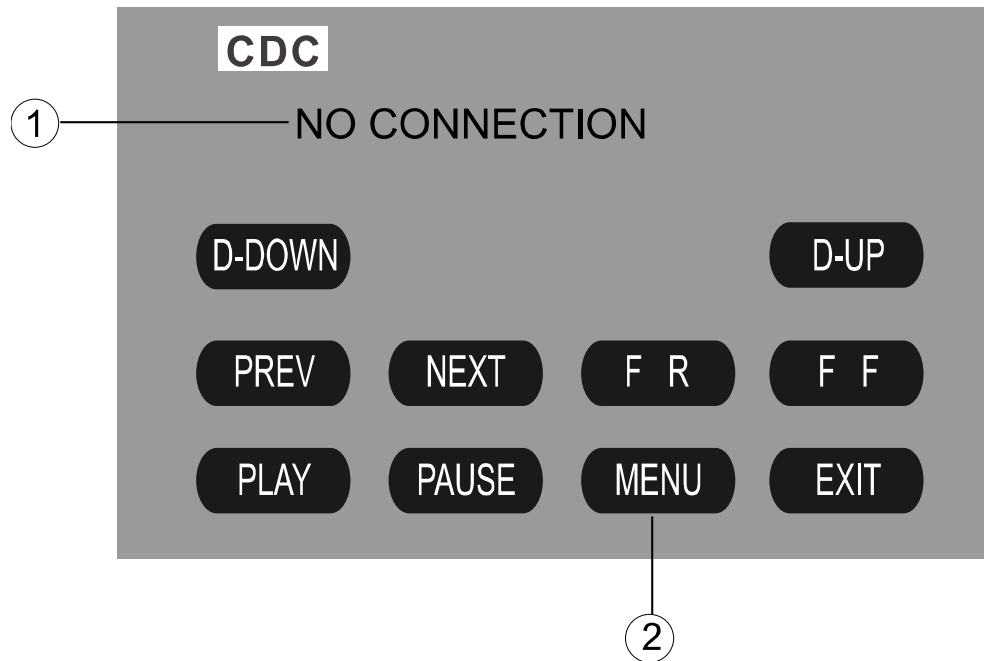

1, INFORMATION

It indicates that the unit does not connect the CD/DVD changer.

2, MENU

Touch the icon to return the main menu.

SYSTEM SETUP

Touch the icon "SETUP" or press the [SYSTEM] button of panel to enter the SETUP of system parameters:

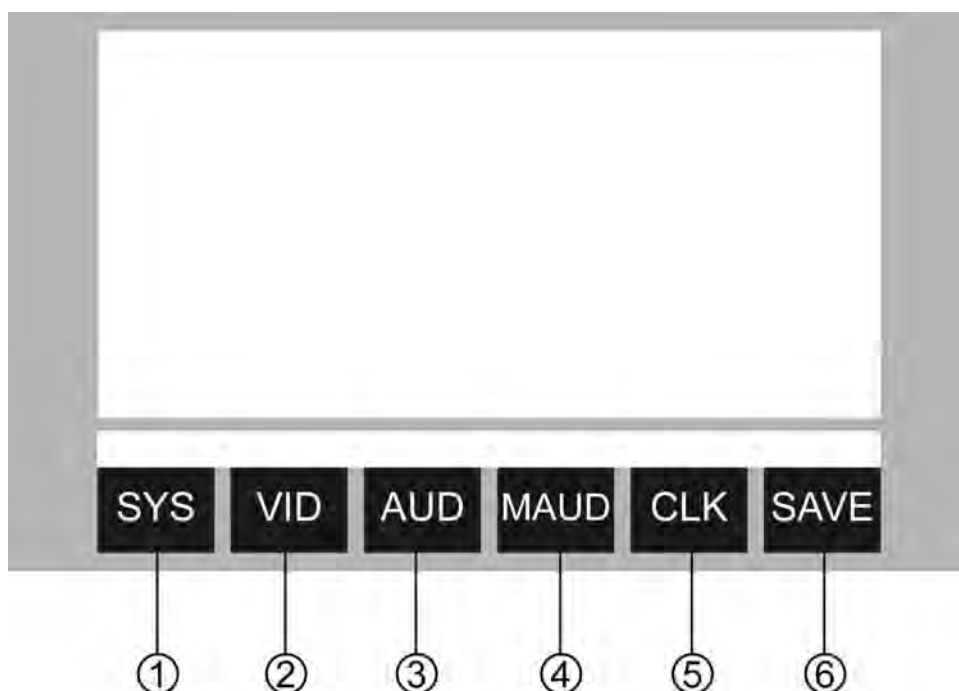

- 1. SYSTEM SETUP**
- 2. VIDEO SETUP**
- 3. AUDIO SETUP**
- 4. MORE AUDIO SETUP**
- 5. CLOCK SETUP**

Touch the icon 1~5 to select the main menus directly.

6. SAVE SETTINGS

Touch the icon 5 to save all settings and exit SETUP.

SETUP MENU OPERATION

Press the [ENTER / BAND] button of remote control to switch the main menus as following:

SYSTEM – VIDEO – AUDIO – MORE AUDIO – CLOCK – SYSTEM

Press the [v] / [^] buttons of remote control to select the item you want to change.
Press the [<] / [>] buttons of remote control to change the value of item.
Holding on pressing the [SYSTEM] button of panel to exit SETUP of system parameters.

SYSTEM SETUP

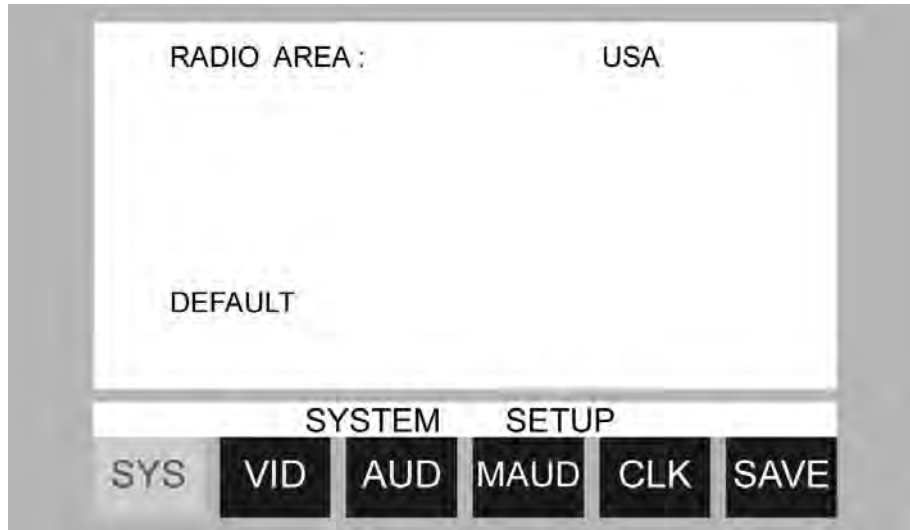

RADIO AREA: USA – JAPAN – OIRT – EUROPE – ASIA – USA

DEFAULT: the unit will restore all default settings of Sound Parameter, Picture Parameter & Tuner Parameter.

VIDEO SETUP

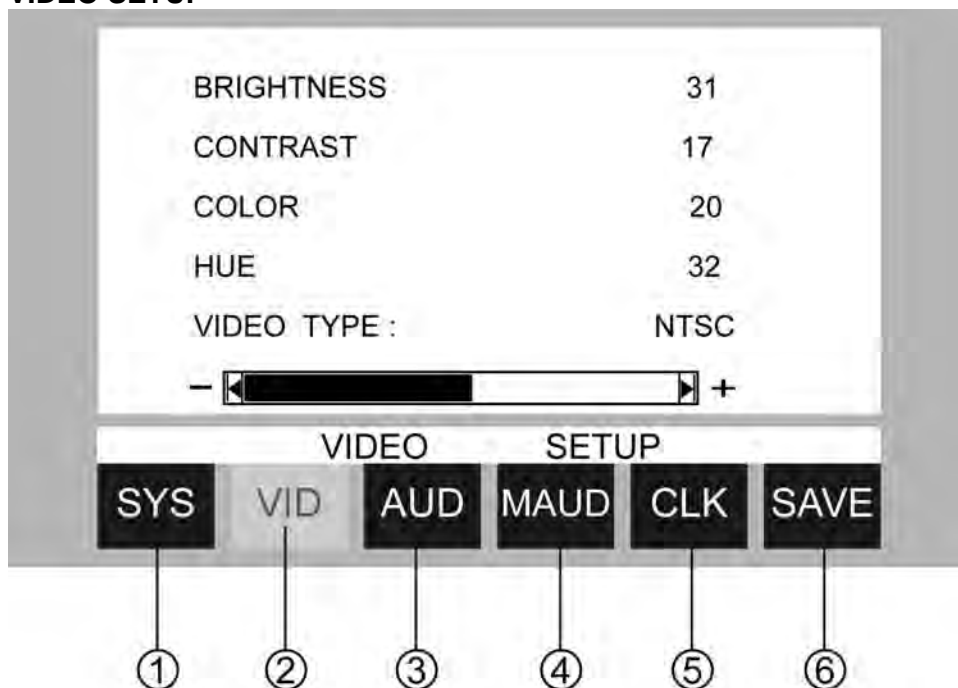

BRIGHTNESS: 0 ~ 64

CONTRAST: 0 ~ 64

COLOR: 0 ~ 64

HUE: 0 ~ 64

VIDEO TYPE: NTSC – PAL – AUTO – NTSC

NOTE:

It is available to setup of HUE under NTSC VIDEO TYPE only.

AUDIO SETUP

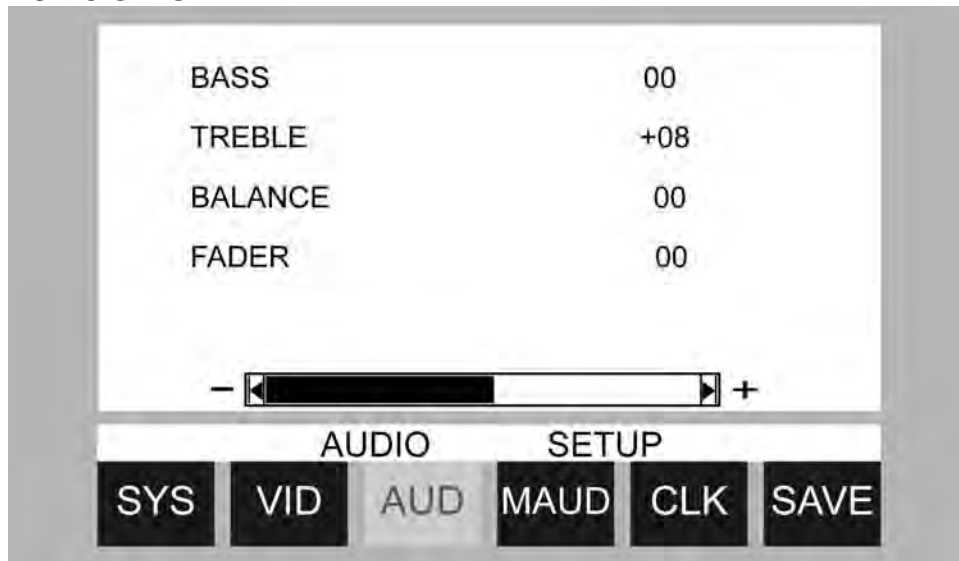

BASS: - 15 ~ + 15
TREBLE: - 15 ~ + 15
BALANCE: L 15 ~ R 15
FADER: F 15 ~ R 15

MORE AUDIO SETUP

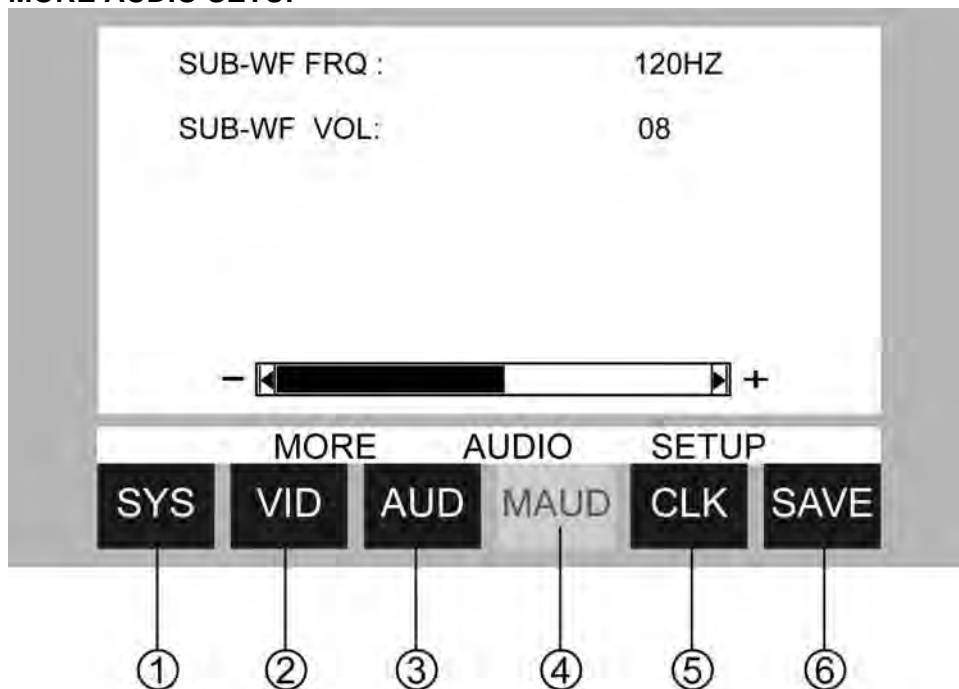

SUB-WOOFER FRQ: 80HZ – 120HZ – 160HZ – OFF – 80HZ
SUB-WOOFER VOL: 0 ~ 15

CLOCK SETUP

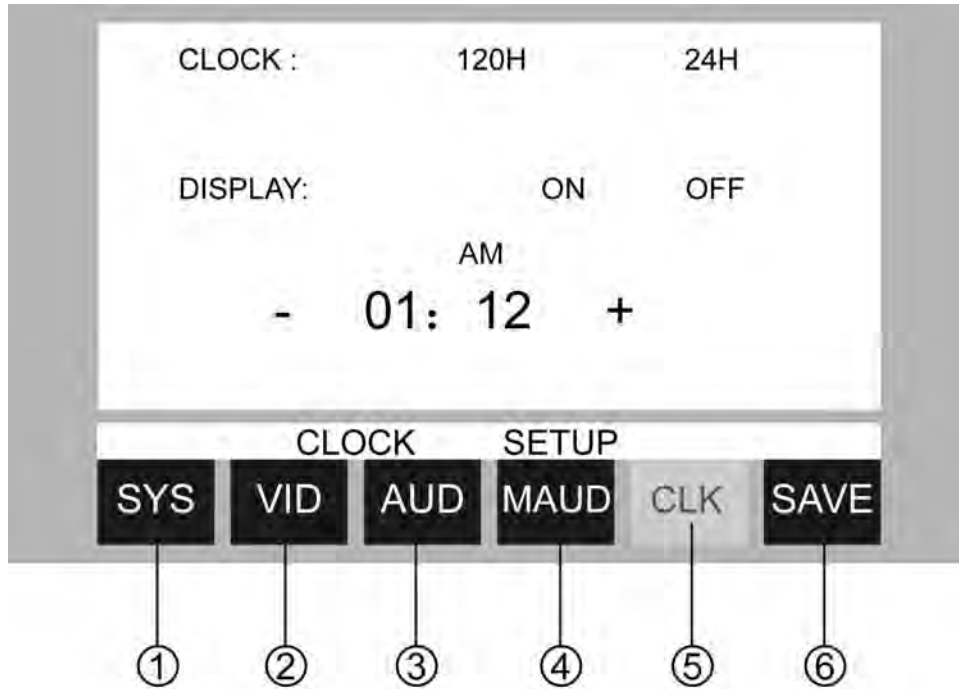

CLOCK: 12H / 24H
DISPLAY: ON / OFF
HOUR: 00 ~ 23
MINUTE: 00 ~ 59

DVD SETUP MENU

SETUP MENU OPERATION

Press the [SETUP] button of remote control to enter the DVD SETUP Menu.

Press the [<] / [>] buttons to switch the main menus as following:

SYSTEM – LANGUAGE – AUDIO – VIDEO – SPEAKER – DIGITAL

Press the [^] / [v] buttons to enter the submenus from main menus.

Press the [^] button on the top submenu or press the [v] button on the bottom of submenu to exit the submenus to main menus.

Press the [^] / [v] buttons to select the submenus as your need.

Press the [>] or [ENTER] buttons to enter the items of submenus.

Press the [<] button to exit the items of submenus.

Press the [v] / [^] buttons to select the item you want to change.

Press the [ENTER] button to confirm the item you have selected and exit to the submenus.

Press the [SETUP] button of remote control or press the [ENTER] button on the submenu EXIT SETUP to exit the DVD SETUP Menu and save all settings.

NOTE

Effective only DVD, SD & USB Mode.

SYSTEM SETUP

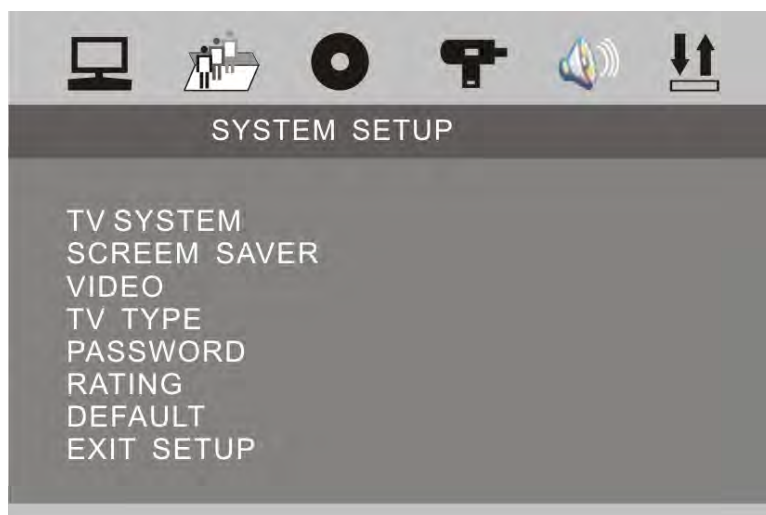

TV SYSTEM

Following options are available for the TV Display:
NTSC

SCREEN SAVER

Select ON or OFF.

VIDEO

Following options are available for the TV Display:

INTERLACE-YUV TV-RGB P-SCAN YPBPR S-VIDEO

TV TYPE

Following options are available for the TV Display:

4 : 3 PS 4 : 3 LB 16 : 9

PASSWORD

Setup the password for Parental Ratings change. The default password is 0000.

RATING

Following options are available for the Parental Ratings:

1 KID SAFE 2 G 3 PG 4 PG 13
5 PG - R 6 R 7 NC - 17 8 ADULT

The Parental Ratings could be changed after the correct password input.

DEFAULT

The unit will restore all default settings by selecting this option.

LANGUAGE SETUP

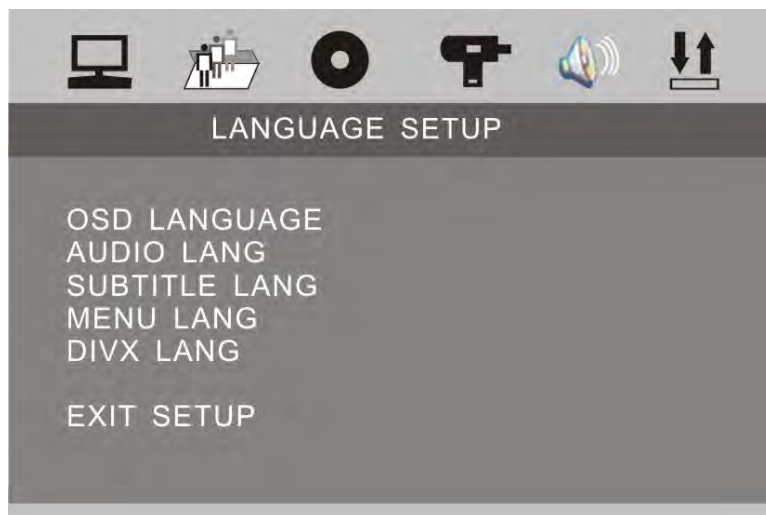

OSD LANGUAGE

Following options are available for the OSD LANGUAGE:

ENGLISH GERMAN SPANISH FRENCH PORTUGUESE
ITALIAN RUSSIAN DUTCH SWEDISH KOREAN
DANISH NORWEGIAN POLISH HUNGARIAN

AUDIO LANGUAGE

Following options are available for the AUDIO LANGUAGE:

ENGLISH GERMAN SPANISH FRENCH PORTUGUESE
ITALIAN RUSSIAN DUTCH SWEDISH KOREAN
DANISH NORWEGIAN POLISH HUNGARIAN

SUBTITLE LANGUAGE

Following options are available for the SUBTITLE LANGUAGE:

ENGLISH	GERMAN	SPANISH	FRENCH	PORTUGUESE
ITALIAN	RUSSIAN	DUTCH	SWEDISH	KOREAN
DANISH	NORWEGIAN	POLISH	HUNGARIAN	

MENU LANGUAGE

Following options are available for the MENU LANGUAGE:

ENGLISH	GERMAN	SPANISH	FRENCH	PORTUGUESE
ITALIAN	RUSSIAN	DUTCH	SWEDISH	KOREAN
DANISH	NORWEGIAN	POLISH	HUNGARIAN	

DIVX LANGUAGE

Following options are available for the DIVX LANGUAGE:

CENTRAL	EU
WESTERN	EU
KOREAN	

AUDIO SETUP



AUDIO OUT

Following options are available for the AUDIO OUT:

SPDIF / OFF	SPDIF / RAW	SPDIF / PCM
-------------	-------------	-------------

KEY

Following options are available for the KEY:

b	-4	-2	0	+2	+4	#
---	----	----	---	----	----	---

VIDEO SETUP

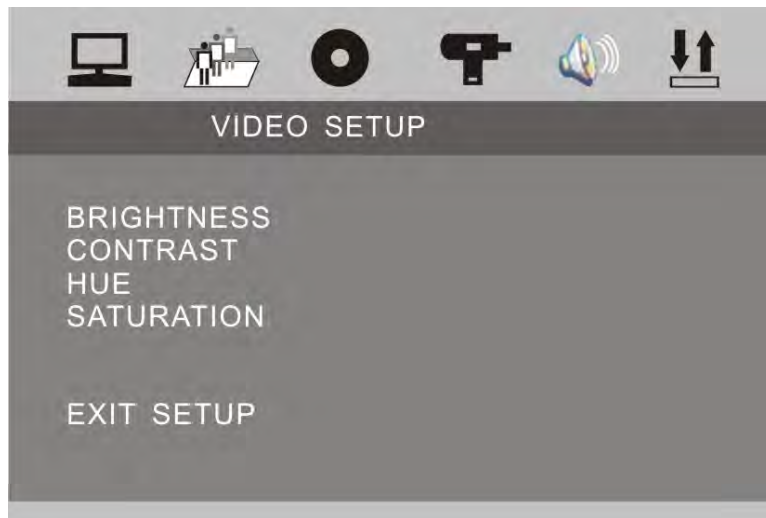

BRIGHTNESS

Following options are available for the BRIGHTNESS:

0 2 4 6 8 10 12

CONTRAST

Following options are available for the CONTRAST:

0 2 4 6 8 10 12

HUE

Following options are available for the HUE:

-6 -4 -2 0 +2 +4 +6

SATURATION

Following options are available for the SATURATION:

0 2 4 6 8 10 12

SPEAKER SETUP



DOWNMIX

Following options are available for the DOWNMIX:
LT / RT Stereo VSS

BASS MODE

Following options are available for the BASS MODE:
ALL LG SPK ALL SM SPK MIXED SPK

DIGITAL SETUP



OP MODE

Following options are available for the OP MODE:
LINE OUT RF REMOD

DYNAMIC RANGE

Following options are available for the DYNAMIC RANGE:
FULL 6 / 8 4 / 8 2 / 8 OFF

DUAL MONO

Following options are available for the DUAL MONO:
STEREO MONO L MONO R MIX MONO

TROUBLE SHOOTING

If any of problem persists after checking the below list, Please consult your nearest service dealer.

Never attempt to disassemble and repair unit personally.

Problem	Cause	Corrective Action
GENERAL		
Unit will not power on	ACC Fuse blown Car battery fuse blown illegal operation	Install new fuse with correct rating Install new fuse with correct rating Press the RESET button located in the bottom right corner of the front panel
Remote control does not work	Battery depleted Battery installed incorrectly	Replace battery with new one Remove battery and install correctly
No/low audio output	Improper audio output connection Volume set too low Speakers damaged Heavily biased volume balance Speakers wiring is in contact with metal Part or car	Check wiring and correct Increase volume level Review wiring diagram and check MUTE connection Replace speakers Adjust the channel balance to the center position Insulate all speaker wiring connections
Poor sound quality or distortion	Pirate disc is in use Speaker power rating not compatible with unit Speaker is shorted	Use original copy Connect proper speakers Check speaker contact
Unit resets itself when engine is off	Incorrect connection between ACC and Positive battery wire	Check wiring and correct
TUNER		
Weak station searching	Auto antenna is not fully extended Auto antenna not properly connected LOCAL function is activated	Connect the auto antenna control cable properly Connect the auto antenna control cable properly Turn LOCAL function off
TFT MONITOR		
No image	Incorrect connection to parking brake wire PARKING is activated and parking brake is not engaged	Check wiring and correct Stop vehicle in safe place and apply parking brake
Flashing image or interference appears on screen	DVD is not compatible with current TV system settings Image blurred, distorted, or dark	Change setup to accommodate disc
Prolonged image or improper height/width ratio display	Improper video signal connections Improper aspect ratio setup	Check wiring and correct Use correct aspect ratio setting

Problem	Cause	Corrective Action
VCD		
Cannot insert disc	Disc already inside unit	Eject current disc and insert new one
Disc does not play back	Disc is warped or scratched Disc is dirty or wet Incompatible disc is used Disc rating exceeds Parental Lock rating limit Disc region code is not compatible with unit Disc is inserted upside down	Use disc in good condition Clean disc with soft cloth Use compatible disc Change parental Lock settings to lower restriction Use compatible disc Change Parental Lock settings to lower restriction Use disc with proper region cod Insert disc with label side up
Image blurred , distorted, or dark	Disc is illegally copied	Use original disc
PBC cannot be used during VCD playback	PBC is not available on the disc	
No repeat or searching while playing VCD	PBC is on	Turn PBC off
MP3		
Interruption occurred during playback	Disc is dirty or scratched	Clean disc or replace
	File is damaged/bad recording	Recreate disc with good files
Incorrect playback message displayed	Message is longer than LCD can display	

Error Messages

Message Displayed	Cause	Corrective Action
Loading	Disc is being read	
No disc	Disc is dirty	Clean disc with soft cloth
	Disc is upside down	Insert disc with label side up
	Disc not present in loading compartment	Insert disc
Bad Disc	Disc is dirty	Clean disc with soft cloth
	Disc is upside down	Insert disc with label side up
Unknown disc	Disc format is not compatible with this unit	
Region Error	DVD is not compatible with region code of unit	
Error	illegal mechanism operation	Press EJECT key for 5 seconds to reset loading mechanism

SPECIFICATIONS

GENERAL

Supply Voltage	: 14.4 V DC (10.8-16 V DC Allowable)
Load Impedance	: 4 Ω
Max Power Output	: 50 W x 4
Bass 100Hz	: \geq 10dB
Treble 10KHz	: \geq 10dB
Dimension (approx)	: 187 x 188 x 110 mm (d/w/h)
Mounting (approx)	: 160 x 178 x 100 mm (d/w/h)

FM TUNER

Frequency Range	: 87.5-107.9 MHz (USA) : 87.5-108.0 MHz (Europe/China)
IF	: 10.7 MHz
Usable Sensitivity	: \leq 15 dB μ V
Stereo Separation	: \geq 27 dB(1KHz)
Frequency Response	: 20-10000 Hz

AM TUNER

Frequency Range	: 530-1710 KHz (USA) : 522-1620 KHz (Europe) : 531-1602 KHz (China)
IF	: 450 KHz
Usable Sensitivity	: \leq 34 dB μ V

DVD PLAYER

Signal System	: PAL/NTSC
Signal-to-noise Ratio	: \geq 80 dB(1KHz)
Distortion	: \leq 0.5%

MONITOR

Resolution	: 1440 (w) x 234 (H) (RGB)
Brightness	: 350 cd/m ²
Contrast	: 300:1

NOTE:

Specifications and design are subject to modification without notice due to improvements in technology.

DISC NOTES

- Disc formats supported by this player



Handling and Cleaning

- Dirty, dusty, scratched or warped discs will cause misoperation.
- Do not place stickers or make scratches on discs.
- Do not warp discs.
- A disc should always be kept in its case when not in use to prevent from damage.
- Do not place discs in the following places:
 1. Direct sunlight.
 2. Dirty, dusty and damp areas.
 3. High temperature places.
 4. On the seats or dashboard.

Disc Cleaning

Use a dry soft cloth to wipe the surface. If the disc is quite dirty, use a soft cloth slightly moist with isopropyl (rubbing) alcohol. Never use solvent such as benzene, thinner or conventional record cleaners which may mar the surface of the disc.

NOTE:

A disc may become somewhat scratched (although not enough to make it unusable) depending on your handling it in the condition of the usage environment. These scratches are not an indication of any problem with the player.

Repairing New Discs with Rough Spots

A new disc may have rough edges on its inside and outside edges. If a disc with rough edges is used, the proper setting will not be performed and the player will not play the disc. Therefore, remove the rough edges in advance by using a ballpoint pen or pencil. To remove the rough edges, press the side of the pen or pencil against the inside and outside edges of the disc.

