

**7" Wide Touch Screen**

**EXACT Double-Din In-Dash Motorized TFT Monitor/DVD/AM/FM**

**Bluetooth Function**

# Operating Manual

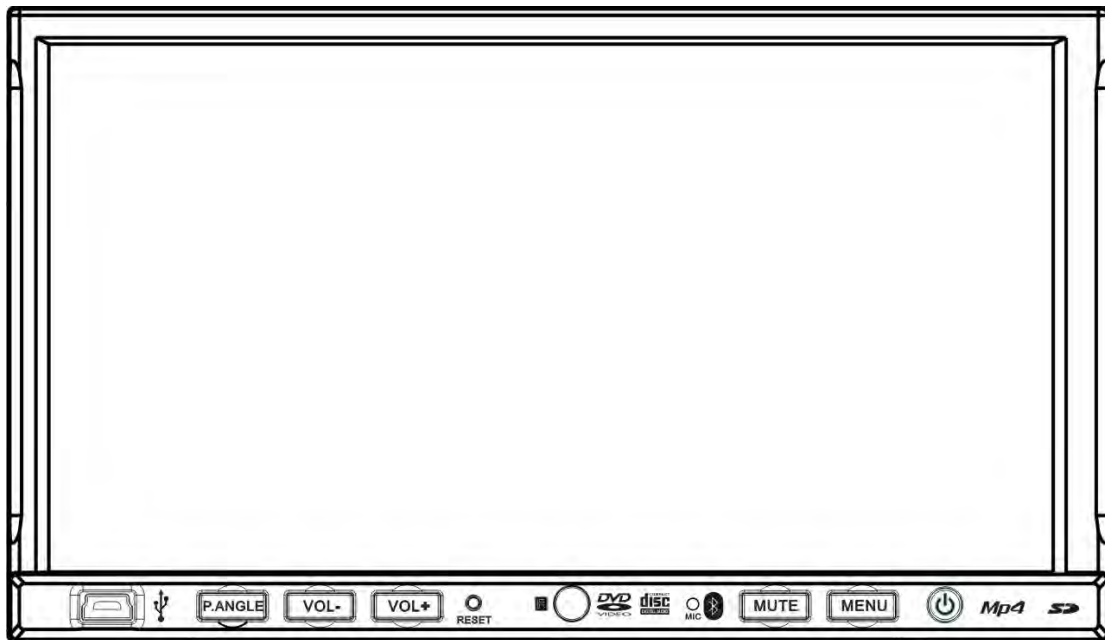

## **TABLE OF CONTENTS**

Safety Information .....	2
Features .....	3
Accessories.....	4
Unit Installation.....	5
Unit Removal .....	7
Wire Connection .....	8
Front Panel .....	10
Rear Panel .....	12
Remote Control .....	13
Touch Screen Operations. ....	17
Touch Screen Calibrate .....	17
Main Menu .....	18
Radio Operations .....	19
DVD Operations .....	22
USB Operations .....	24
SD CARD Operations .....	24
Bluetooth Operations .....	25
iPod Operations .....	33
AV IN 1 Operations .....	35
AV IN 2 Operations .....	36
CDC Operations .....	37
System Setup .....	39
DVD Setup Menu.....	43
Trouble Shooting.....	48
Specifications .....	50
Disc Notes .....	51

## **SAFETY INFORMATION**

**Please read the manual carefully before operating this unit and keep it for future reference.**

**CAUTION:** This unit is a class 1 laser product. To prevent direct exposure to the laser system, do not open the unit. The laser beam may hurt your eyes. If the unit requires adjustments, contact an authorized service centre.

### **USE THIS PRODUCT SAFELY**

Be sure you fully understand the following safety information:

#### **When driving**

Keep the unit at an appropriate sound level. Driving with the sound at a level preventing you from hearing sounds outside and around the car may cause an accident.

#### **When cleaning**

Do not expose the product to water or excessive moisture. This could cause short circuit, fire or other severe damage.

#### **When parked**

Parking in direct sunlight can result in very high temperature levels inside your car. Let the interior and unit cool down before switching the unit on.

#### **NOTE:**

*Do not use and store the player in dusty, hot or humid environment.*

#### **FUSE REPLACEMENT – WARNING!**



**Never replace any fuse with one of a higher value than the fuse supplied with your unit. Using a higher current rated fuse may cause damage to your unit and/or electrical wiring.**

## **FEATURES**

- Fully Motorized 4 Position Drop Screen With Last Angle Memory
- Electronic Touch Screen Functions Include DVD, Radio, USB, & MP-3/4
- DVD/DVD-RW/CD/CD-R/CD-RW/MP-3/MP-4/Divx
- All Functions Are Displayed On Screen Via OSD (Fourteen Languages)
- 30-Second Electronic Anti-shock Mechanism
- Accessory iPod Input Connection (Cable Not Included)
- USB Mini Input For MP-3 Music, Divx, Xvid & MP-4 Movies
- SD Card Slot For MP-3 Music Or MP-4 Movies (Memory Not Included)
- Front Panel A/V Input For Audio/Video MP-3/MP-4 Players
- IR Repeater Function For External Remote Eye
- Antenna Trigger Wire
- Amplifier Trigger Wire
- Brake Screen Safety Trigger
- AM/FM With 30 Pre-sets (18/FM – 12/AM)
- Auto Store Pre-set Scan
- 4-Channel High Power 50 x 4 Channels (Mosfet Power)
- Dual RCA Outputs (Front & Rear)
- Sub Woofer Selectable Frequency Outputs (80, 120, 160Hz)
- Variable Sub Woofer Volume Control
- 1-Auxiliary Video Input For Back-up Camera
- 1-RCA Video Output
- LO/DX And Stereo Mono Selector Switch
- Electronic (Bass, Treble, Volume, Balance, Fader)
- Pre-set EQ Functions (Rock, Pop, Classic Jazz, User)
- Digital Clock
- DVD, PAL/NTSC Selectable
- USA/Europe Frequency Stepping
- Resolution: 1440 x 234
- Panel Brightness: 450NIT
- ISO/ Double DIN
- Full Function Remote Control
- Last Position DVD Memory
- Bluetooth Function
- Improved Graphic User Interface

### **NOTE:**

*This user's manual is only for reference.*

*Modifying rights are reserved.*

*Specifications are subject to change without notice.*

**ACCESSORIES**

1

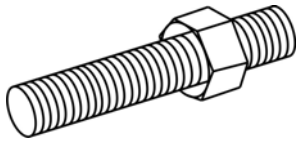

Bolt

2

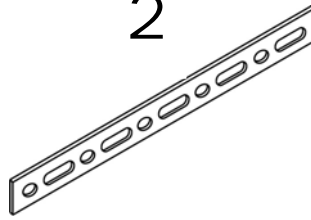

Steel Bar x 1

3



M5X5 Screws x 8

4

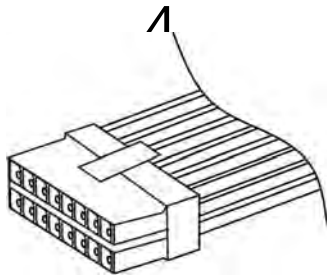

Connector Wire x 1

5

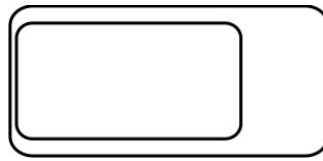

Remote Control x 1

6



Keys x 2

7

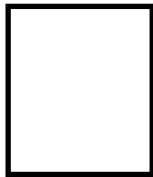

Operational Manual x 1

8

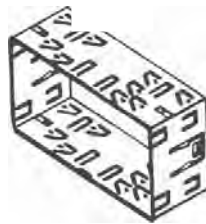

Mounting Sleeve x 1

9



USB Cable x 1

10



iPod Cable x 1  
(option)

11

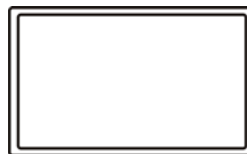

Trim Bezel x 1

12

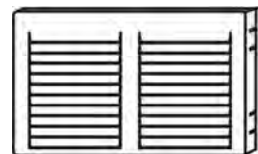

Air Vent Cover x 1

13

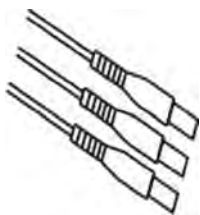

AV Cable x 1

14



External Microphone x 1

## UNIT INSTALLATION

1, connect the power cable with unit.

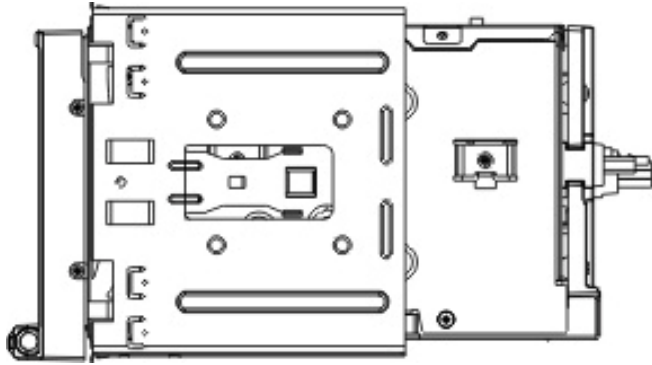

2, press the [P.ANGLE] button to slide down the front panel.

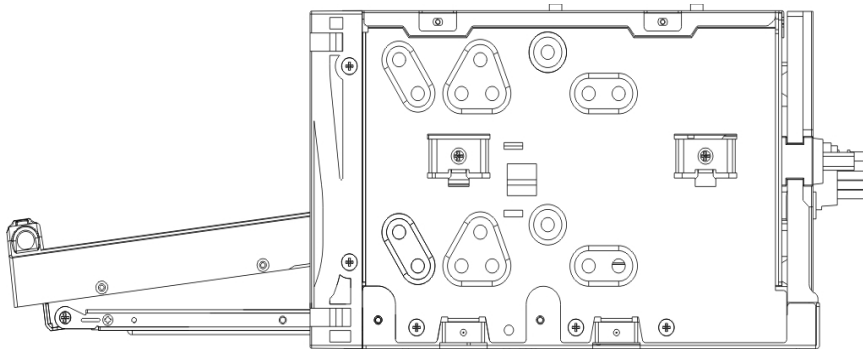

3, turn over the unit, loose the screws.

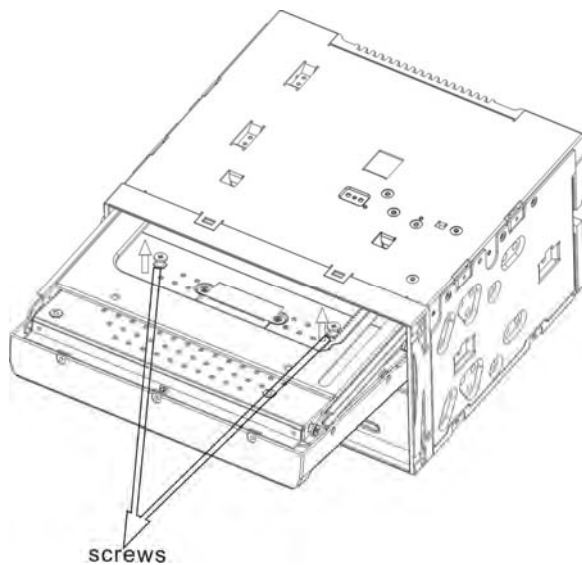

4, press the [P.ANGLE] button to close the front panel.

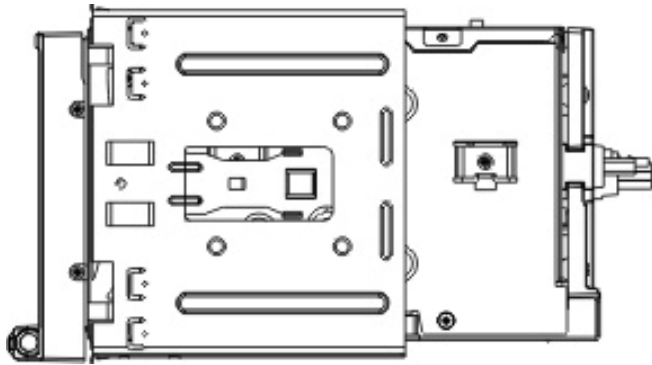

5, install the Mounting sleeve into the dashboard.

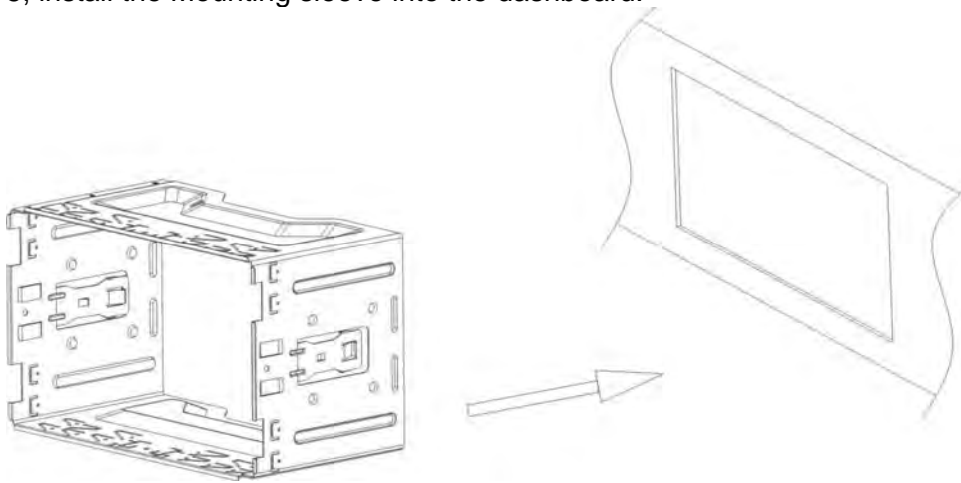

6, install the unit into the mounting sleeve.

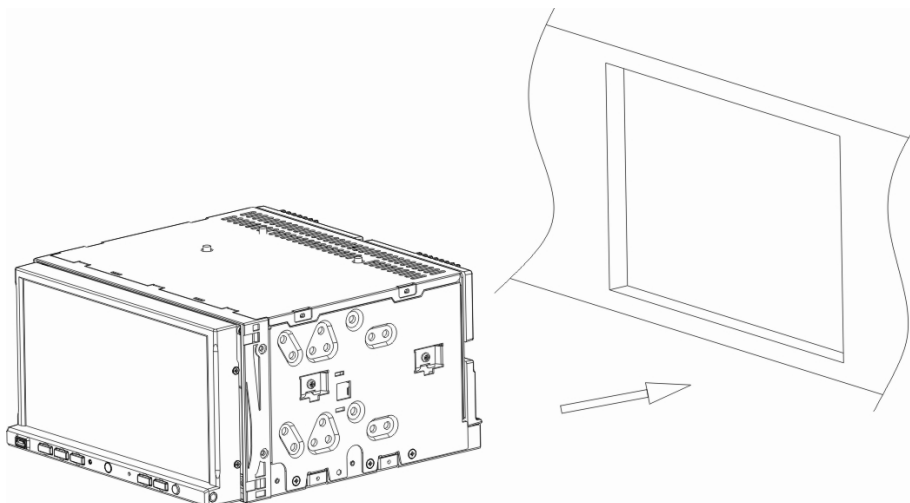

**NOTE:**  
Screws are useful to protection during shipment.

## UNIT REMOVAL

Insert the keys supplied with the unit on both sides (as illustrated) as this will release the internal locks so you can slide the unit out.

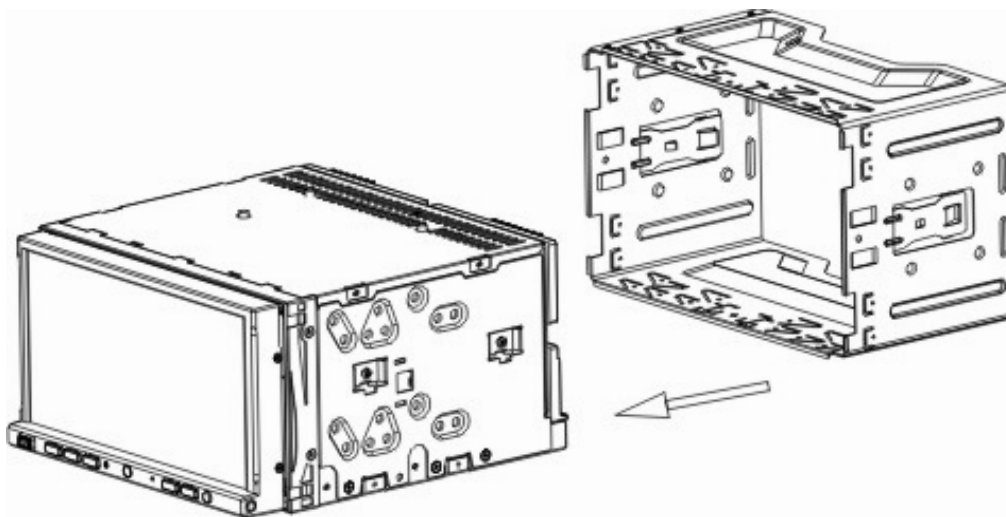
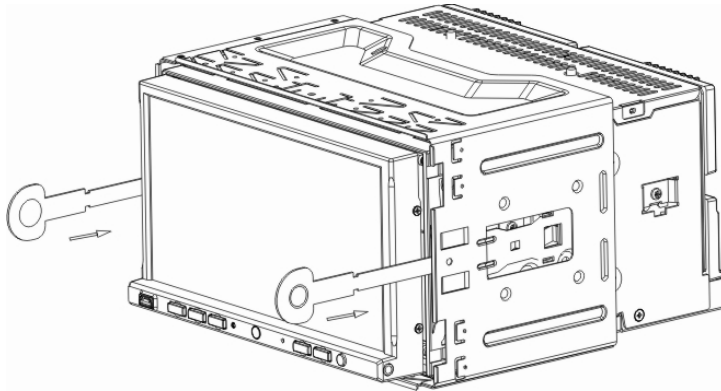

## WIRE CONNECTION

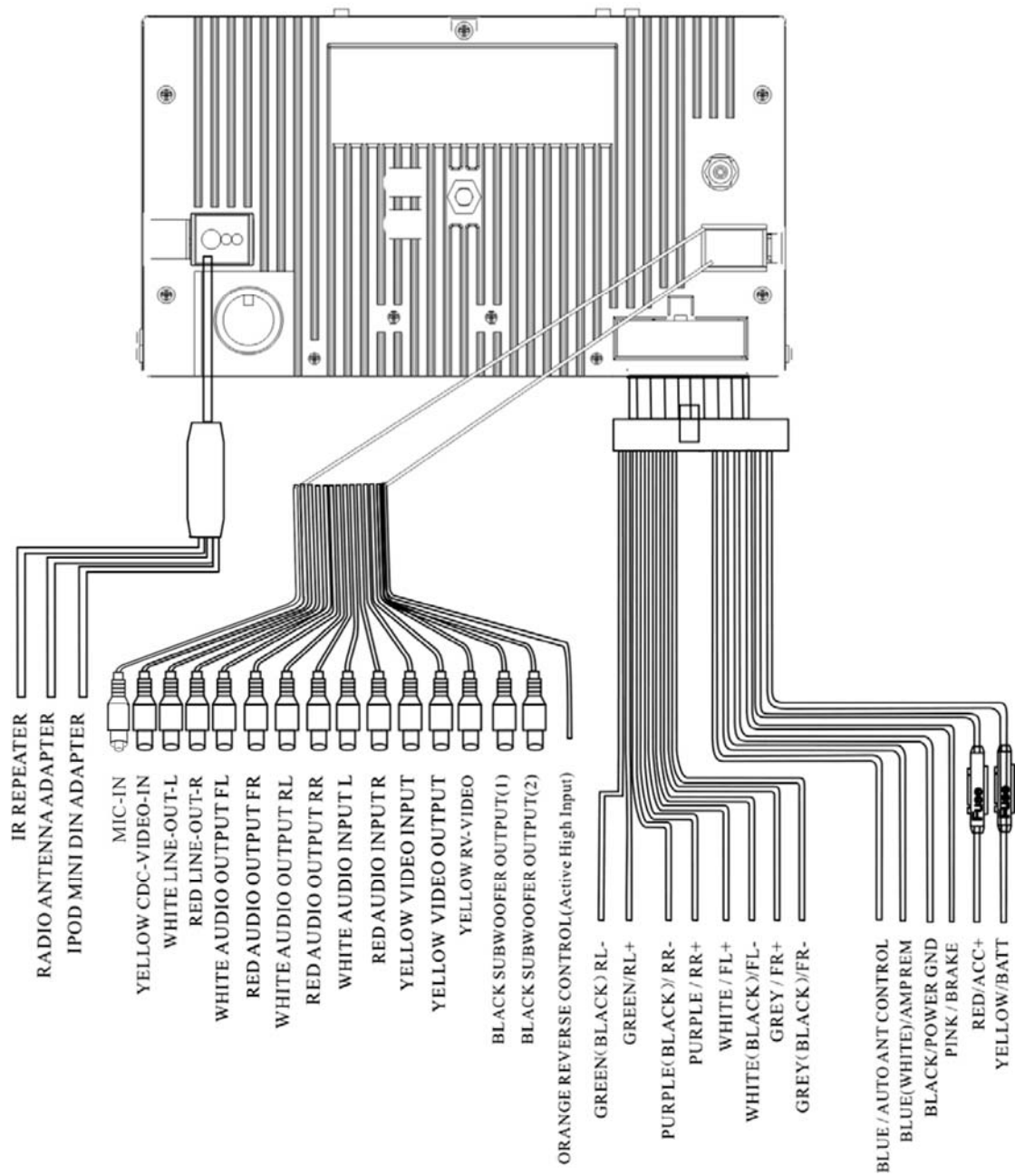

### **NOTE:**

Plug the external microphone input into the MIC-IN jack for Bluetooth.

### **Brake Control**

It is necessary to connect the Brake Control wire to the Hand-brake switch of the car. While driving, the TFT monitor will display the alarm picture (see as follows) in order to ensure the safety.

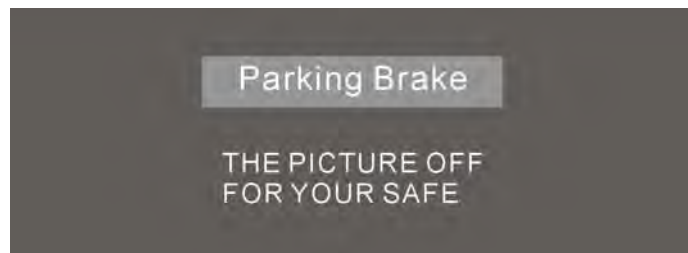

Under the Rear View Mode, the Brake Control function is no effective.

### **Auto Antenna Control**

Connect the auto antenna control wire AUTO\_ANT (see Wiring Diagram); the antenna will lift when the unit startup; it will descend when the unit turnoff.

## FRONT PANEL

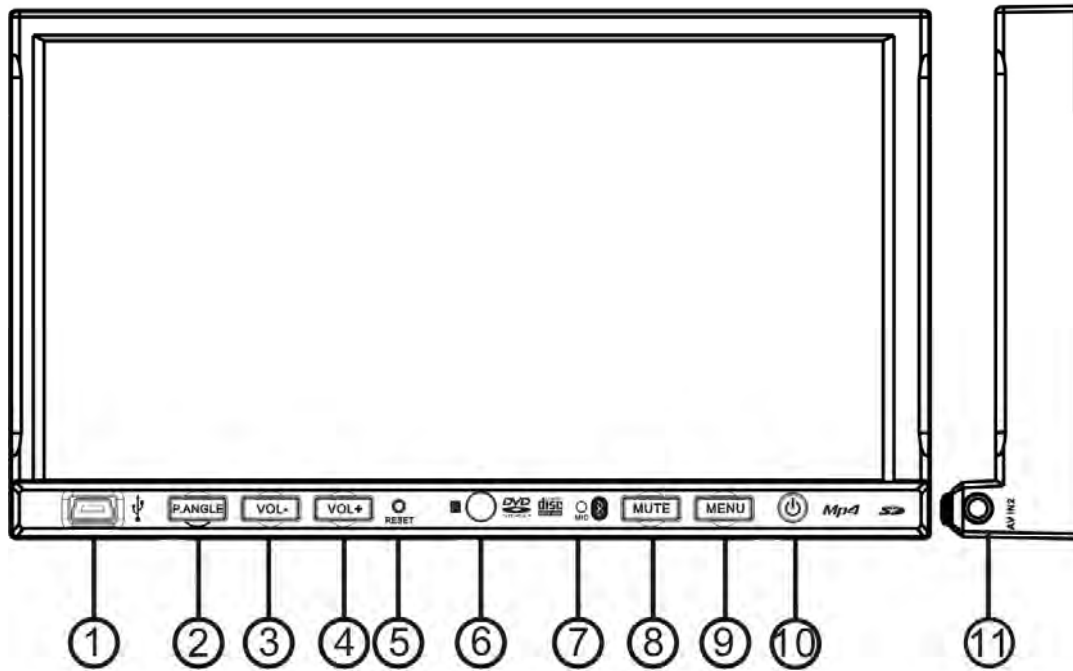

- |                           |           |                    |
|---------------------------|-----------|--------------------|
| 1. MINI USB               | 5. RESET  | 9. MENU            |
| 2. OPEN / CLOSE / P.ANGLE | 6. REMOTE | 10. POWER / SOURCE |
| 3. VOLUME -               | 7. MIC    | 11. AV IN 2        |
| 4. VOLUME +               | 8. MUTE   |                    |

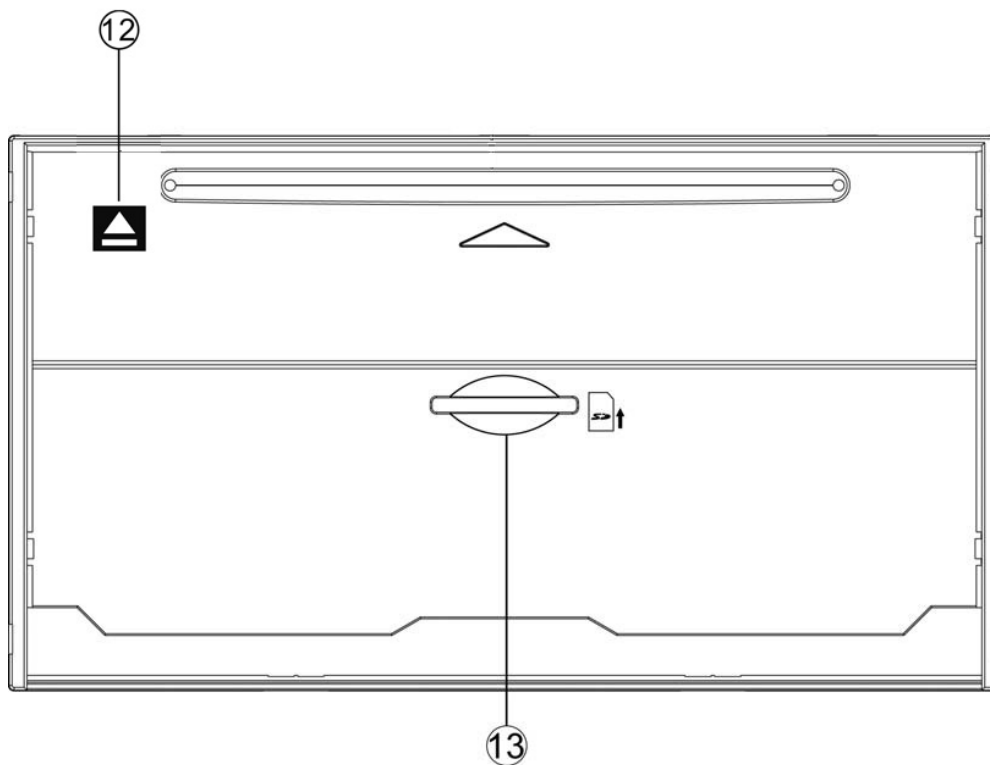

12. EJECT

13. SD CARD SLOT

## 1. MINI USB

The unit will be switched to DVD Mode automatically when USB connected, and play the songs, pictures, videos in USB.

## 2. [P.ANGLE/OPEN/CLOSE]

Press the button to open/close the monitor.

Hold pressing the button to adjust the angle of the front panel as following:

Angle 1 - Angle 2 - Angle 3 - Angle 4 - Angle 1

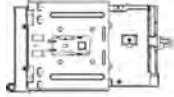

Angle 1

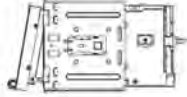

Angle 2



Angle 3

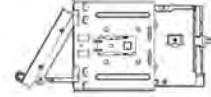

Angle 4

## TFT Viewing Angle Calibrate

When "Power Off", press the buttons 1, 2, 3, [BAND/ENTER] of remote control;

Then the monitor should display 'TFT ANGLE CALIBRATE';

The motor and gear drives are now back to their factory positions.

## 3. [VOLUME-] / 4. [VOLUME+]

Press to increase / decrease the volume.

## 5. [RESET]

Press the button to switch back to all the original factory settings.

Keep in mind this will erase all your preset radio stations and any EQ settings you may have made and saved.

## 6. REMOTE

Infrared Remote Receiver

## 7. [MIC]

Microphone.

## 8. [MUTE]

Press the button to switch off the sound; press it again to resume to the previous volume level.

## 9. [MENU]

Press to return to the main menu.

## 10. [POWER/SOURCE]

Press the button to turn the unit ON;

Hold on pressing the button to turn the unit OFF.

When the unit in turned ON, press the button to toggle between the different modes as following:

**RADIO – DVD – USB – SD – IPOD – CDC – AV IN 1 – AV IN 2 – BLUETOOTH – RADIO**

## NOTE:

*The unit could be switched to DVD Mode if disc inside;*

*The unit could be switched to USB Mode if Mini USB connected;*

*The unit could be switched to SD Mode if SD / MMC Card connected;*

*The unit could be switched to IPOD Mode if iPod connected;*

### **11. AV IN 2**

Connect an external audio/video device to this jack to watch to the device through your car video system.

### **12. [EJECT]**

When flip down the front panel, press to eject / load a disc.

### **13. SD CARD SLOT**

The unit will be switched to SD Mode automatically when SD card inserted, and play the songs, pictures, videos in SD card.

## **REAR PANEL**

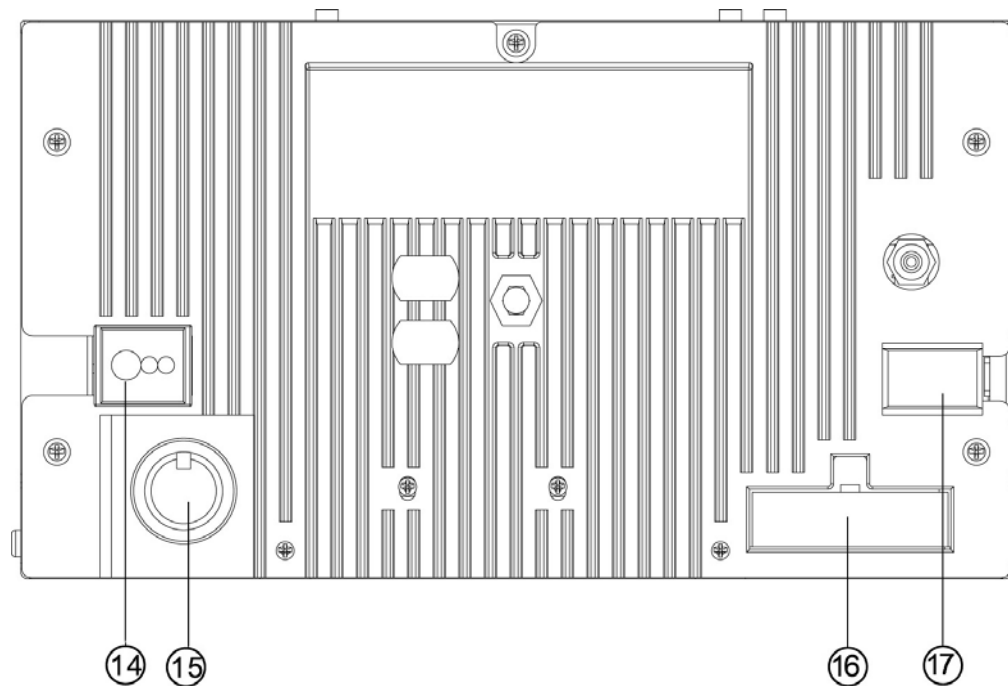

**14. RADIO ANTENNA, IPOD MINI DIN & IR REPEATER ADAPTER**

**15. CDC ADAPTER**

**16. 16PIN SOCKET**

**17. VIDEO AUDIO OUTPUT & INPUT**

## REMOTE CONTROL

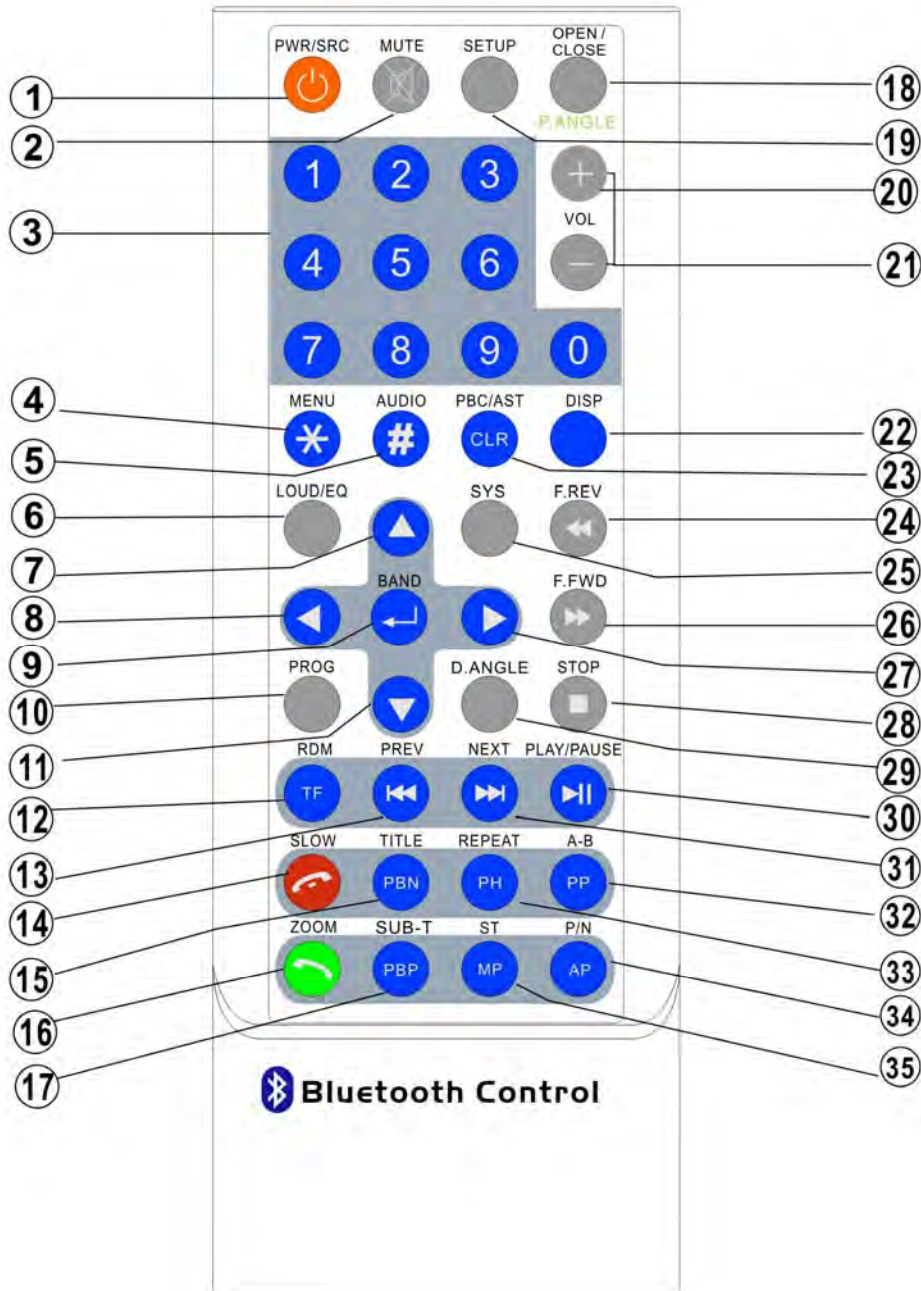

- |                       |                            |                      |
|-----------------------|----------------------------|----------------------|
| 1. POWER/SOURCE       | 13. PREVIOUS               | 25. SYSTEM           |
| 2. MUTE               | 14. SLOW / END CALL        | 26. F.FWD            |
| 3. NUMBER BUTTONS     | 15. TITLE / PBN            | 27. RIGHT(Seek up)   |
| 4. MENU / *           | 16. ZOOM / CALL            | 28. STOP             |
| 5. AUDIO / #          | 17. SUBTITLE / PBP         | 29. D.ANGLE          |
| 6. LOUD / EQ          | 18. OPEN / CLOSE / P.ANGLE | 30. PLAY / PAUSE     |
| 7. UP (Tune up)       | 19. SETUP                  | 31. NEXT             |
| 8. LEFT (Seek Down)   | 20. VOLUME+                | 32. A-B / PHONE PAIR |
| 9. ENTER / BAND       | 21. VOLUME-                | 33. REPEAT / PHONE   |
| 10. PROGRAM           | 22. DISPLAY                | 34. PAL / NTSC / AP  |
| 11. DOWN(Tune Down)   | 23. PBC / AST / CLEAR      | 35. STEREO / MP      |
| 12. RANDOM / TRANSFER | 24. F.REV                  |                      |

### **1. [POWER/SOURCE]**

Same functions as key on front panel.

### **2. [MUTE]**

Press the [MUTE] button to switch off the sound; press it again to resume to the previous volume level.

### **3. [NUMBERS 0~9]**

For 1~6, press these buttons to store the current radio station or recall the stored station under the Radio Mode.

For 0~9, press these buttons to select the tracks, and input the number code.

### **4. [MENU]**

Press to return to the boot menu when playing DVD disc.

### **5. [AUDIO]**

Press to select dialogue language when playing DVD disc.

Press to select left audio channel, right audio channel or stereo when playing VCD disc.

### **6. [LOUD/EQ]**

Press to adjust the EQ setting as following:

**USER – POP – CLASSIC – ROCK – JAZZ – USER**

Hold on pressing to turn the LOUD function on / off.

### **7. [^] / 8. [<] / 11. [v] / 27. [>] Direction Key**

Under the DVD Setup menu:

Press the [v] / [^] buttons to move the cursor upward / downward to select item.

Press the [<] / [>] buttons to move the cursor leftward / rightward to select item.

Under RADIO Mode:

Press the [<] / [>] buttons to switch the stored stations.

Hold on pressing the [<] / [>] buttons to fast seeking the next available channel by decreasing / increasing the tuning frequency; seeking will stop by pressing any button.

Press the [v] / [^] buttons to decrease / increase the frequency step by step.

Hold on pressing the [v] / [^] buttons to fast seeking by decreasing / increasing the tuning frequency; seeking will stop when loose the button.

### **9. [BAND/ENTER]**

In RADIO mode, press the [BAND] button to switch the wave band as following:

FM1 – FM2 - FM3 - AM1- AM2 - FM1

In DVD mode, press the [ENTER] button to confirm the Setup Menu.

### **10. [PROGRAM]**

Press to enter / exit the PROGRAM Function when playing the VCD, CD, MP3 disc.

### **12. [RANDOM/TRANSFER]**

Press to turn RAMDOM function on / off when playing CD / VCD disc (PBC OFF).

When talking the phone, press to transfer the call between the unit and your cell phone.

**13. [PREVIOUS]**

Press to skip to play the pervious track.

**14. [SLOW/END CALL]**

Press to activate slow motion playback. (DVD Mode only)

Press to reject or hang up a call.

**15. [TITLE/PBN]**

Press to enter the title menu when playing DVD disc.

Press to enter the next page of phone number list in phonebook.

**16. [ZOOM/CALL]**

Press to magnify the picture display when play DVD, VCD disc.

Press to call a number or to receive a cell phone call.

**17. [SUB-T/PBP]**

Press to select the subtitle language when playing DVD disc.

Press to enter the previous page of phone number list in phonebook.

**18. [OPEN/CLOSE/P.ANGLE]**

Same functions as key on front panel.

**19. [SETUP]**

Press to enter the DVD SETUP menu.

**20. [VOL+] / 21. [VOL-]**

Press to increase / decrease the volume.

**22. [DISPLAY]**

Press to display current playback information when playing DVD disc.

**23. [PBC/AST/CLEAR]**

Press to select the PBC function on / off when playing VCD disc.

Hold on pressing to seek radio station / TV channel automatically under RADIO / TV Modes.

Press to cancel or clear the numbers you have input.

**24. [F.REW]**

Press to select fast reverse with different speed.

**25. [SYSTEM]**

Press to enter / exit the System Parameter Setup menu.

**26. [F.FWD]**

Press to select fast forward with different speed.

**28. [STOP]**

Press to stop the playback.

**29. [ANGLE]**

Press the [ANGLE] button during playback to select different viewing angles with interactive DVD media.

**30. [PLAY/PAUSE]**

Press to pause the playback when playing; press again to continue playing.

**31. [NEXT]**

Press to skip to play the next track.

**32. [A-B/PHONE PAIR]**

Press to setup A-B repeat playing.

**33. [REPEAT/PHONE]**

Press to select the chapter / title / disc to repeat playing.

**34. [P/N/AUDIO PLAYER]**

Press the button to switch the video output (PAL/NTSC) when playing DVD disc.

**35. [STEREO/MUSIC PAIR]**

Press to turn the stereo on / off under Radio Mode.

**REPLACING THE BATTERIES**

If the remote control has no function or if the operating range reduced, replace the old battery with new one.

1. Pull out the battery holder. Follow the arrow 1 slide it to the right toward the battery while at the same time pull the battery holder away from the remote control.

2. Place the new battery. Place the new lithium battery with the (+) side up.

3. Push the holder back. Using the finger to push in the holder back until the locking sound is heard.

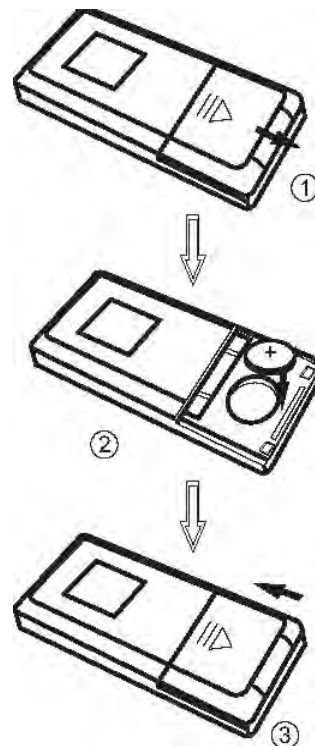

## TOUCH SCREEN OPERATIONS

### TOUCH SCREEN CALIBRATE

When "Power Off", press the buttons 1, 2, 3, 4, 5, [BAND] of remote control to enter the CALIBRATE page:

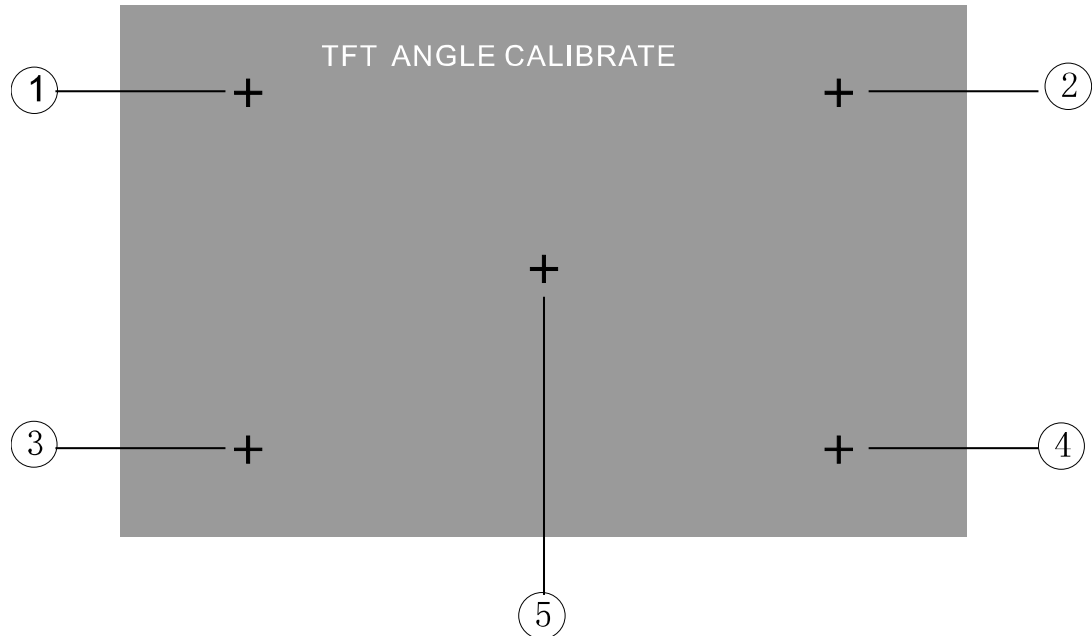

To touch the points from 1 to 5 until the points change to brighter by using a ballpoint pen or pencil.

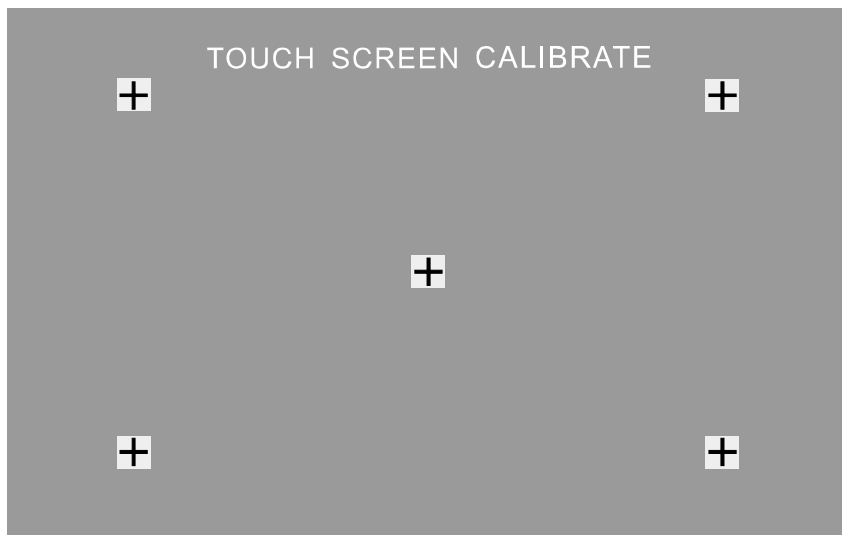

After all 5 points change to brighter, the unit would finish the CALIBRATE and power off again. Then the Touch Screen is restored to their default positions.

## MAIN MENU

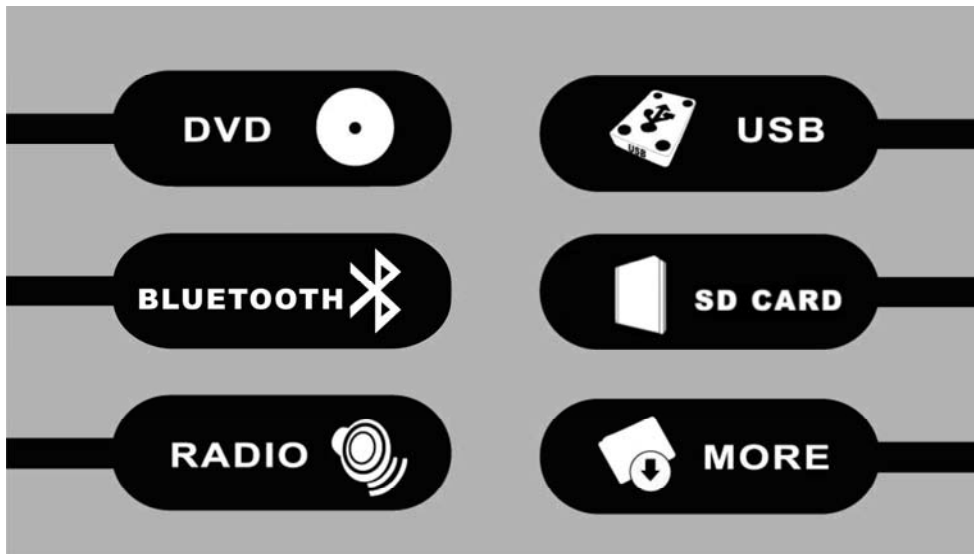

Touch the icon "MORE" to enter the 2<sup>nd</sup> page of main menu:

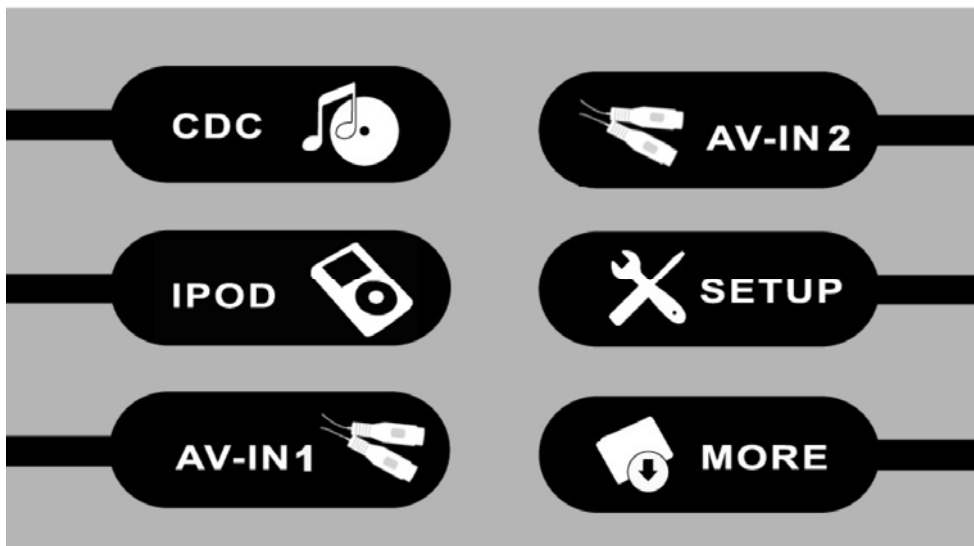

## RADIO OPERATIONS

Touch the icon "RADIO" to enter the **1st operation page of RADIO Mode:**

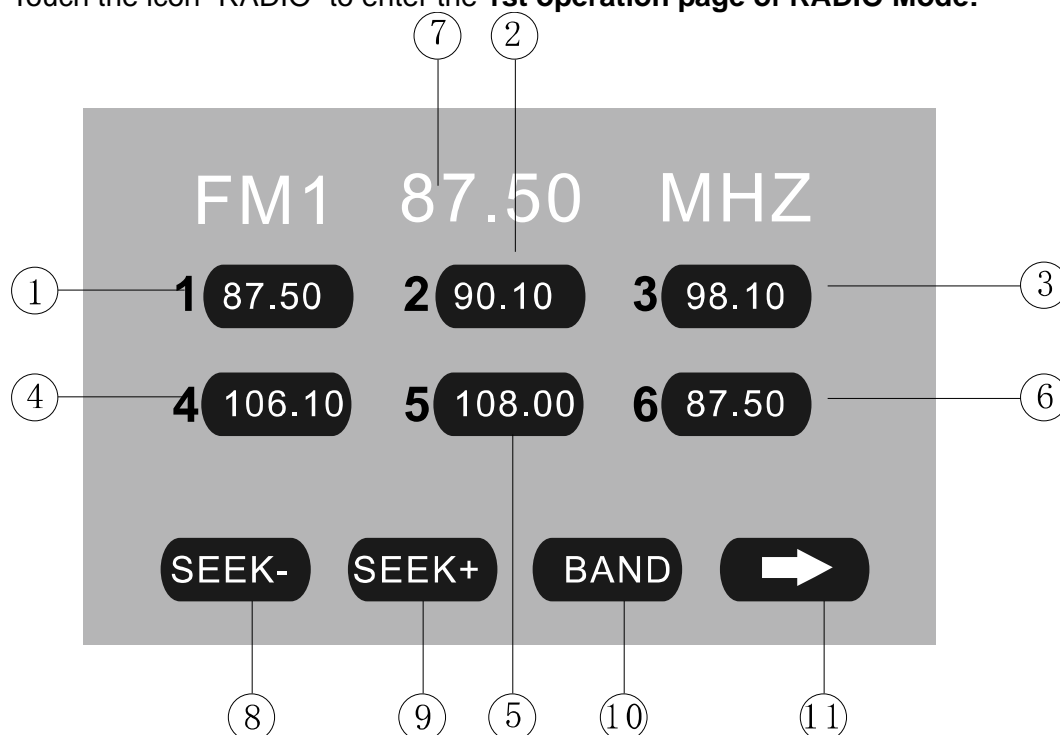

### **1~6. STORED CHANNEL**

#### **Manual Store Radio Station**

Hold on touching the icon, you can store current radio frequency to the stored channel. For example, the current frequency is 98.5MHZ, by hold on touching the icon 1, you can store the radio station of 98.5MHZ to the channel 1.

After manual store radio station, the former stored stations will be instead.

In each wave band, the number icons 1 to 6 represent the stored radio stations.

To hold on pressing the number buttons 1~6 of remote control performs same operation.

#### **Recall a Preset Station**

Touch the icon 1~6 to recall the corresponding stored station in M1~M6 channels. To press the number buttons 1~6 of remote control performs same operation.

### **7. FREQUENCY**

#### **8. SEEK - / 9. SEEK +**

Touch the icon to seek the next available channel by increasing / decreasing the tuning frequency.

Press any button to stop seeking.

Seeking will stop automatically when seek an available channel then play this station. The unit will stop on the beginning frequency if no available station after seeking one cycle.

To hold on pressing [>] / [<] buttons of remote control performs same operation.

#### **10. BAND**

Touch the icon to switch the FM/AM wave band as following:

FM1 - FM2 - FM3 - AM1- AM2 - FM1

To press the [BAND] button of panel or remote control performs same operation.

## 11. NEXT PAGE

Touch the icon to enter the 2<sup>nd</sup> page of RADIO Mode:

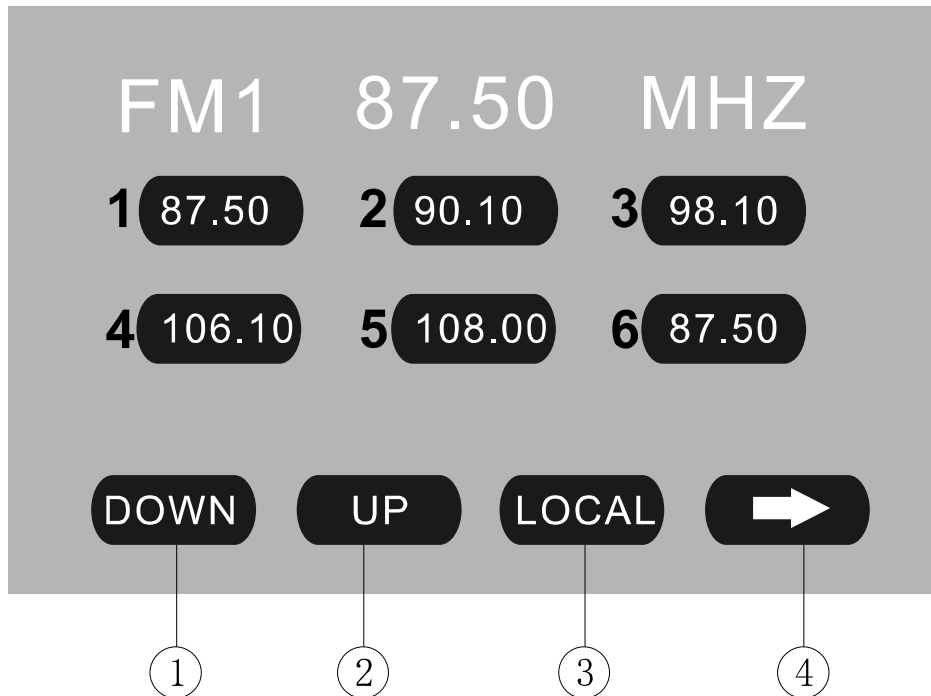

### 1. DOWN / 2. UP

Touch the icons to adjust the frequency downward / upward by step decreasing / increasing.

Hold on touching the icons has same function with [SEEK-] / [SEEK+].

To press the [∇] / [∧] buttons of remote control performs same operation.

### 3. LOCAL: ON / OFF

When you are using the local searching function of LOCAL, you can only receive the radio station with strong enough signals and fine state.

### 4. NEXT PAGE

Touch the icon to enter the 3<sup>rd</sup> page of RADIO Mode:

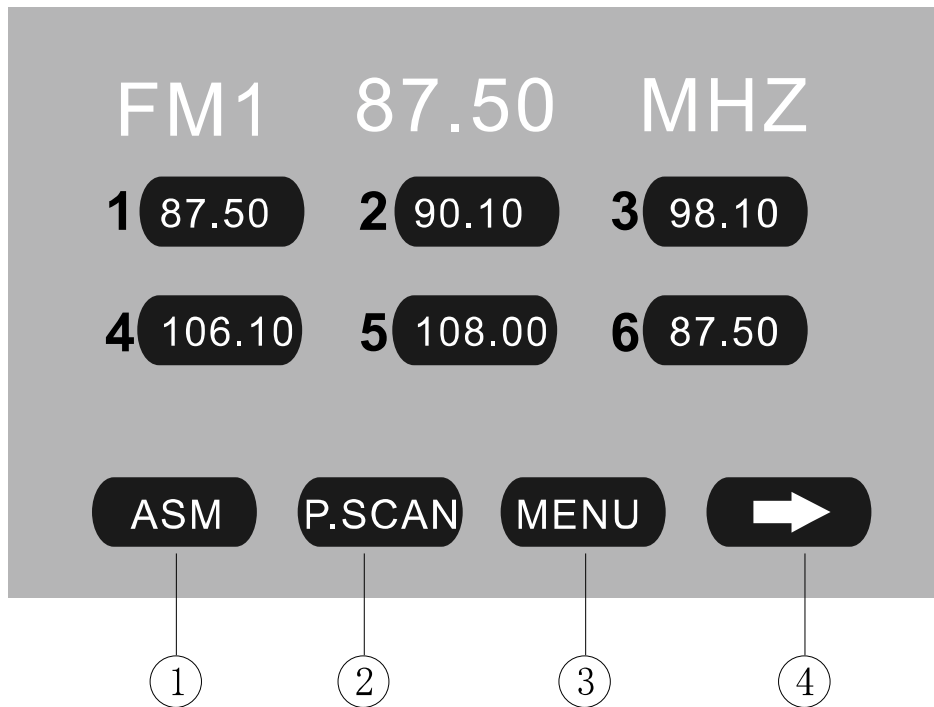

### 1. ASM

Seeking and store the stations

1. Hold on touching the icon to seek stations with the strongest signal from the lowest frequency point in the entire wave bands; press any button to stop seeking. After seeking, the former stored stations will be instead.
2. Store the received effective radio frequency to the six stored channels M1~M6.
3. The unit will play the stations one by one for few seconds; press any button to stop playing.
4. It is independent for FM & AM frequency. There are 3 wave bands of FM1、FM2、FM3 & 2 wave bands of AM1、AM2, each can store 6 radio stations, totally 30 radio stations.
5. The unit will stop on the beginning frequency if no available station after seeking one cycle.
6. To press the [AST] button of panel or hold on pressing the [PBC/AST] button of remote control performs same operation.

### 2. P.SCAN

The unit will play the stored stations one by one for few seconds from FM1, FM2, FM3, AM1, AM2; press any button to stop playing.

### 3. MENU

Touch the icon to return the main menu.

### 4. NEXT PAGE

Touch the icon to enter the 1<sup>st</sup> page of RADIO Mode.

## **DVD OPERATIONS**

Touch the icon “DVD” to enter the DVD Mode if disc inside.

The unit will switch to DVD Mode automatically if loading disc.

The unit will switch to RADIO Mode automatically if ejecting disc.

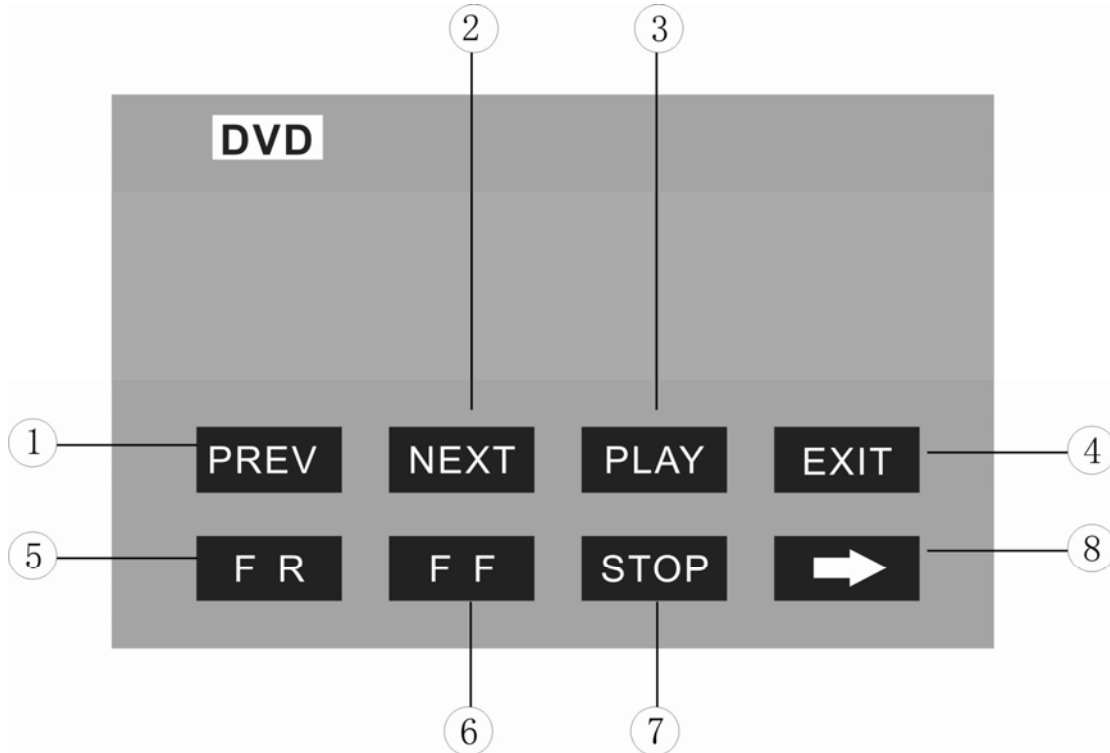

### **1. PREV / 2. NEXT**

Touch the icon to go to the pervious / next chapter, track or song.

To press the [Previous] / [Next] buttons of panel or remote control performs same operation.

### **3. PLAY**

Touch the icon to play or pause the disc.

To press the [PLAY/PAUSE] button of remote control performs the same operation.

### **4. EXIT**

Touch the icon to exit the TOUCH ICONS display.

### **5. F.REV / 6. F.FWD**

Touch the icon to select fast reverse / forward search. Touch the [PLAY] icon to resume to normal playback.

To press the [F.REV] / [F.FWD] buttons of remote control performs the same operation.

### **7. STOP**

During movie playback, touch the icon once; the DVD player memorizes the location where you stopped (touch the [PLAY] icon to resume playing from the memorized location). If you touch the icon twice, the playback will start from the beginning of the disc when you touch the [PLAY] icon.

To press the [STOP] button of remote control performs the same operation.

## 8. NEXT PAGE

Touch the icon to enter the 2<sup>nd</sup> page of DVD Mode:

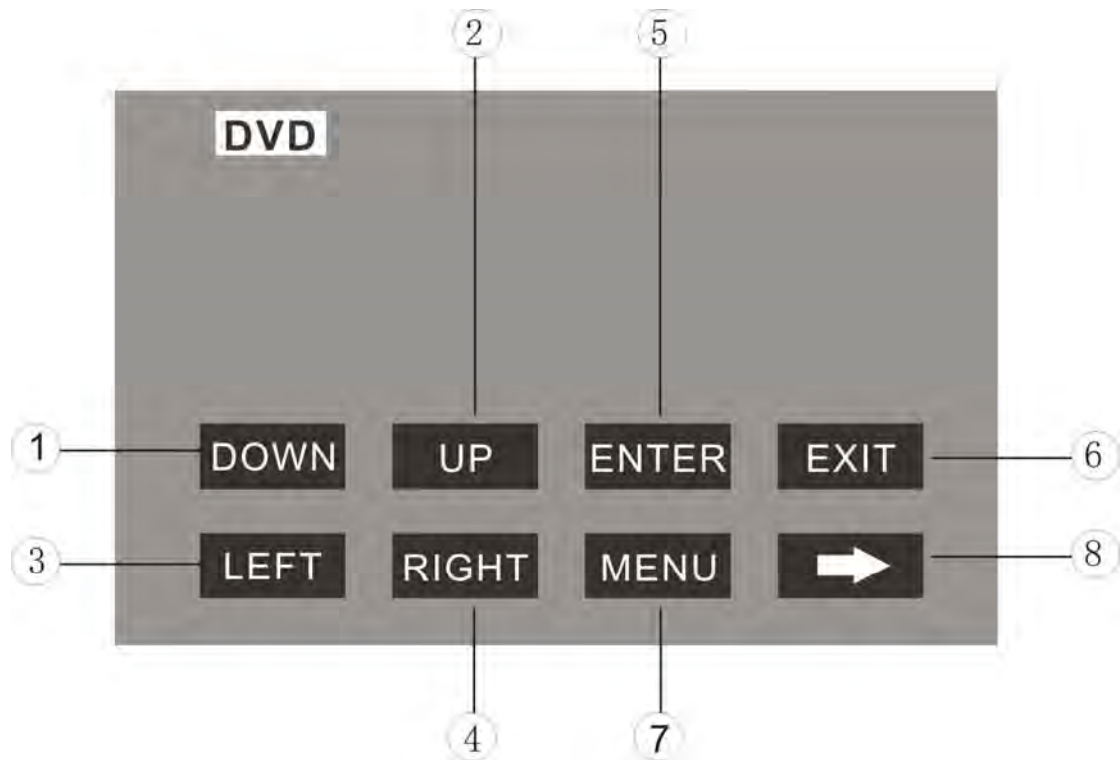

### 1~4. DOWN / UP / LEFT / RIGHT

Touch the direction icons (UP / DOWN / LEFT / RIGHT) to move the cursor to the selected item.

To press the direction buttons (UP / DOWN / LEFT / RIGHT arrow) of remote control performs same operation.

### 5. ENTER

Touch the icon to confirm the selection.

To press the [ENTER] button of remote control performs same operation.

### 6. EXIT

Touch the icon to exit the TOUCH ICONS display.

### 7. MENU

Touch the icon to return the main menu.

## 8. NEXT PAGE

Touch the icon to enter the 1<sup>st</sup> page of DVD Mode.

## **USB OPERATIONS**

Touch the icon “USB” to enter the USB Mode if USB connected.

The unit will switch to USB Mode automatically if connecting USB.

When disconnecting USB, the unit will switch to RADIO Mode automatically if there is no disc in the unit; and the unit will switch to DVD Mode automatically if there is a disc inside.

Under USB Mode, all operations are same as DVD operations.

## **SD CARD OPERATIONS**

Touch the icon “SD CARD” to enter the SD CARD Mode if SD card connected.

The unit will switch to SD CARD Mode automatically if connecting SD card.

When disconnecting SD card, the unit will switch to RADIO Mode automatically if there is no disc in the unit; and the unit will switch to DVD Mode automatically if there is a disc inside.

Under SD CARD Mode, all operations are same as DVD operations.

## **BLUETOOTH OPERATIONS**

Touch the BLUETOOTH icon to enter the Bluetooth mode:

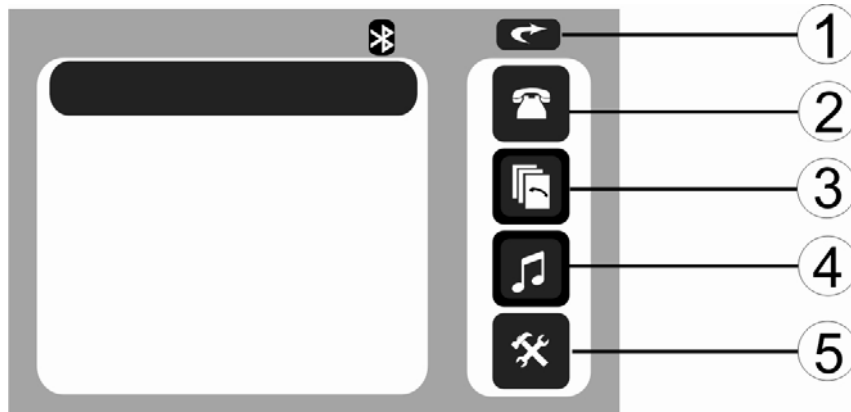

1, RETURN  
4, AUDIO

2, PHONE CALL  
5, SETTINGS

3, PHONEBOOK

### 1, RETURN

Touch the icon to return the MAIN MENU.

To press the [DISPLAY] button of remote control performs same operation.

### 2, PHONE CALL

Touch the icon to enter the phone calling.

### 3, PHONE BOOK

Touch the icon to enter the phone book lookup.

### 4, AUDIO

Touch the icon to enter the audio device operation.

### 5, SETTINGS

Touch the icon to enter the Bluetooth settings.

### **NOTE:**

To press the [BAND] button of remote control to toggle between the different working pages as following:

**PHONE CALL – PHONE BOOK – AUDIO – SETTINGS – PHONE CALL**

## **SETTINGS**



1, INFORMATION DISPLAY 2, AUTO ANSWER  
4, PHONE PAIRING 5, AUDIO PAIRING

3, PHONEC CONNECT  
6, PIN CODE

### **NOTE:**

Touch the icon 2~6, when item is changed to blue color, the item is selected. And touch it again and the item is changed to red color, the operation is active.

To press the [∨] / [∧] buttons of remote control to select the item, and the item would be changed to blue color; To press the [<] / [>] buttons of remote control to activate the operation, and the item would be changed to red color.

1, INFORMATION DISPLAY

2, AUTO ANSWER

Touch the icon to select auto / manual answer when call is coming.

3, PHONEC CONNECT

Touch the icon to select auto / manual phone connect when return back the car.

4, PHONE PAIRING

Touch the icon, then see the below words on information display:

**PHONE PAIR WAITING**

Then set the phone to pair with unit.

Touch the icon again to cancel the pairing, and see the below words on information display:

**PHONE PAIR FAIL**

When paring finished, set the phone connect with unit, then you can see the phone name on information display.

To press the [PHONE PAIR] button of remote control under SETTINGS page performs same operation.

## 5, AUDIO PARING

Touch the icon, then see the below words on information display:

**AUDIO PAIR WAITING**

Then set the audio device to pair with unit.

Touch the icon again to cancel the pairing, and see the below words on information display:

**AUDIO PAIR FAIL**

When paring finished, set the audio device connect with unit, then you can see the audio device name on information display.

To press the [MUSIC PAIR] button of remote control under SETTINGS page performs same operation.

## 6, PIN CODE

You can change the PIN code by remote control. Press the [CLR] key of remote control to clear the PIN code, and input the new 4 digitals number, press the [SETUP] of remote control to save the new code.

### **NOTE:**

The unit can pair with totally 5 different devices including cell phones and audio players.

- 1, When you want to connect another paired cell phone with unit, to press the [PHONE] button of remote control to disconnect the current connecting cell phone; use the another cell phone to connect with the unit without paring operations.
- 2, When you disconnected the current connecting cell phone, also you can press the [PHONE] button of remote control to connect the cell phone with the unit again.
- 3, When you want to connect another paired audio player with unit, to press the [AUDIO PLAYER] button of remote control to disconnect the current connecting audio player; use the another audio player to connect with the unit without paring operations.
- 4, When you disconnected the current connecting audio player, also you can press the [AUDIO PLAYER] button of remote control to connect the audio player with the unit again.

## PHONE CALL

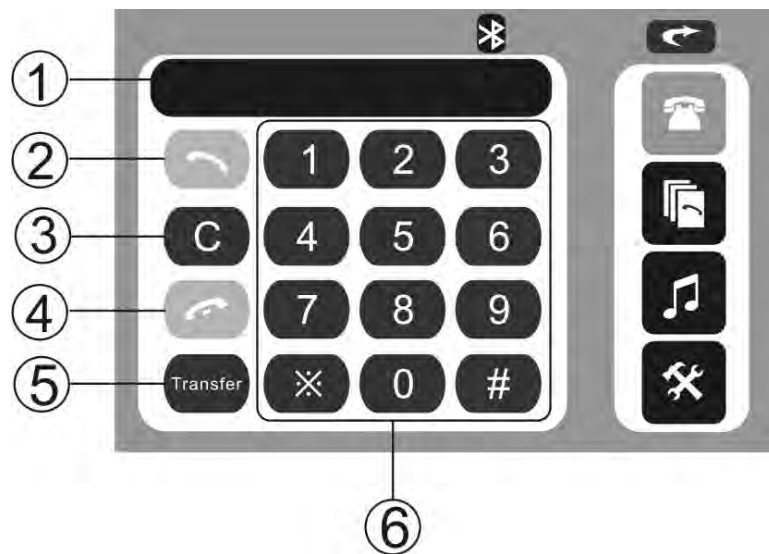

1, INFORMATION DISPLAY  
4, END CALL

2, CALL  
5, TRANSFER

3, CLEAR  
6, NUMBER KEYS

1, INFORMATION DISPLAY

2, CALL

To touch the icon to call a number or to receive a cell phone call.

To press the [CALL] button of remote control performs same operation.

3, CLEAR

To touch the icon to cancel or clear the numbers you have input.

To press the [CLEAR] button of remote control performs same operation.

4, END CALL

To touch the icon to reject or hang up a call.

To press the [END CALL] button of remote control performs same operation.

5, TRANSFER

When talking the phone, touch the icon to transfer the call between the unit and your cell phone.

To press the [TRANSFER] button of remote control performs same operation.

6, NUMBER KEYS

To touch the icon to enter a phone number.

To press the number buttons of remote control performs same operation.

## CALLING OUT

When call out, you will see the below information:

**CALL OUT.\*\*\*\*\***

Then when talking, you will see the below information:

**TALKING.\*\*\*\*\***

And end the call, you will see the below information:

**END CALL.\*\*\*\*\***

## CALLING IN

When call in, you will see the below image:



Then when talking, you will see the below image:



And when end the call, you will see the below image:



## PHONEBOOK

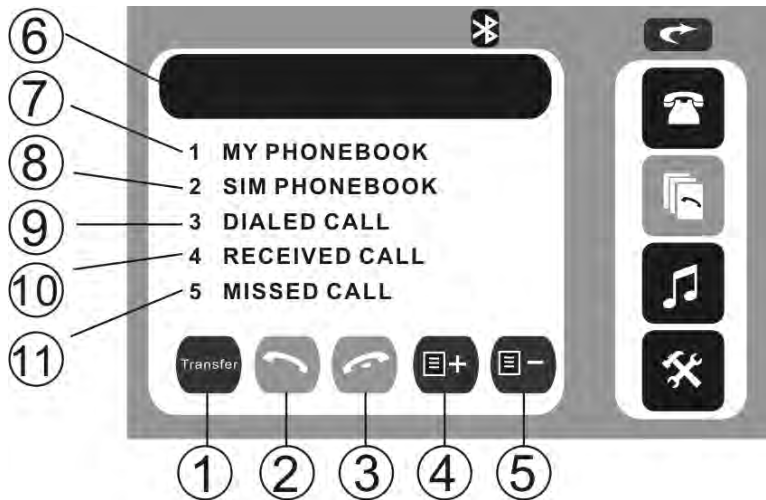

- |                   |                  |                        |
|-------------------|------------------|------------------------|
| 1, TRANSFER       | 2, CALL          | 3, END CALL            |
| 4, PREVIOUS PAGE  | 5, NEXT PAGE     | 6, INFORMATION DISPLAY |
| 7, MY PHONEBOOK   | 8, SIM PHONEBOOK | 9, DIALED CALL         |
| 10, RECEIVED CALL | 11, MISSED CALL  |                        |

### **NOTE:**

Touch the icon 7~11, when item is changed to blue color, the item is selected. And touch it again and the item is changed to red color, the operation is active.

To press the [V] / [^] buttons of remote control to select the item, and the item would be changed to blue color; To press the [<] / [>] buttons of remote control to activate the operation, and the item would be changed to red color.

### 1, TRANSFER

When talking the phone, touch the icon to transfer the call between the unit and your cell phone.

To press the [TRANSFER] button of remote control performs same operation.

### 2, CALL

To touch the icon to call a number or to receive a cell phone call.

To press the [CALL] button of remote control performs same operation.

### 3, END CALL

To touch the icon to reject or hang up a call.

To press the [END CALL] button of remote control performs same operation.

### 4~5, PREVIOUS PAGE / NEXT PAGE

There are 5 numbers in each page, touch the icon to see previous / next page.

To press the [PBP] / [PBN] buttons of remote control performs same operation.

### 6, INFORMATION DISPLAY

### 7, MY PHONEBOOK

The phone numbers are stored in phone.

### 8, SIM PHONEBOOK

The phone numbers are stored in SIM card.

### 9, DIALED CALL

The phone numbers are dialed in phone.

### 10, RECEIVED CALL

The phone numbers are received in phone.

### 11, MISSED CALL

The phone numbers are missed in phone.

Touch the icon to enter the phonebook, you will see the below image:

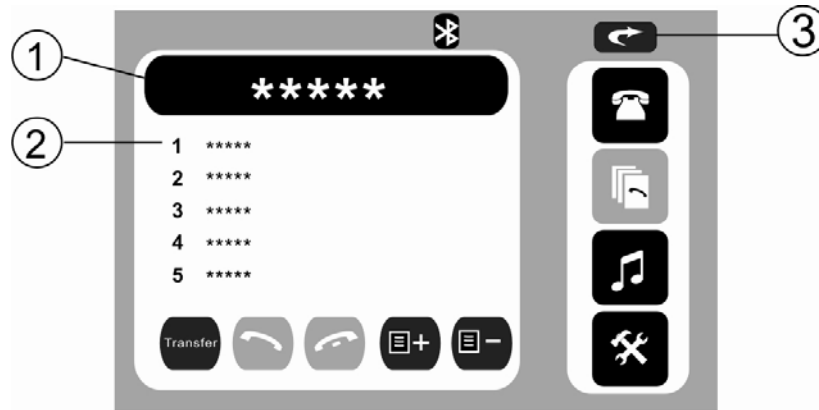

1, INFORMATION DISPLAY

2, CURRENT PHONE NUMBER

3, RETURN

#### **NOTE:**

Touch the icon 2, when item is changed to blue color, the item is selected.

To press the [V] / [^] buttons of remote control to select the item and the item would be changed to blue color.

1, INFORMATION DISPLAY

You will see the phone number of the item in blue color.

2, CURRENT PHONE NUMBER

If this number is stored, you will see the name; if not, you will see the phone number.

3, RETURN

Touch the icon to return to PHONE BOOK page.

To press the [DISPLAY] button of remote control performs same operation.

## AUDIO

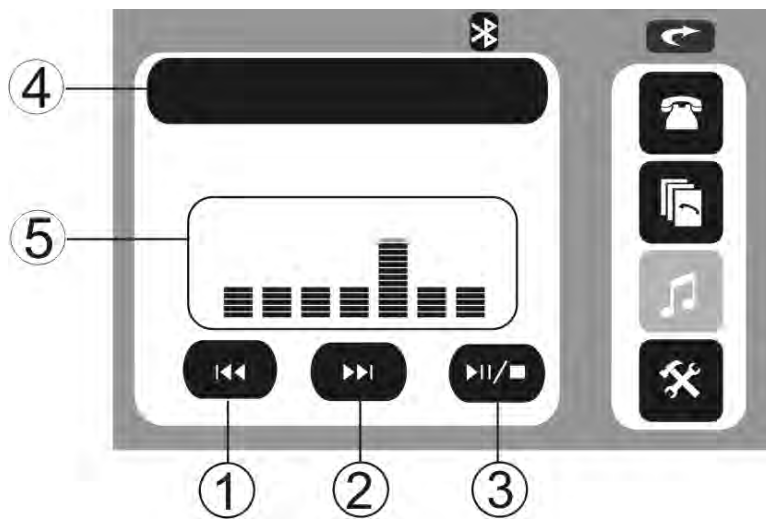

- 1, PREVIOUS                      2, NEXT                      3, PLAY / PAUSE  
4, INFORMATION DISPLAY        5, EQUALIZER DISPLAY

### 1, PREVIOUS

Touch the icon to select the previous track.

To press the [PREVIOUS] button of remote control performs same operation.

### 2, NEXT

Touch the icon to select the next track.

To press the [NEXT] button of remote control performs same operation.

### 3, PLAY / PAUSE

Touch the icon to pause playback when playing; touch it again to continue playing.

To press the [PLAY / PAUSE] button of remote control performs same operation.

### 4, INFORMATION DISPLAY

It could be displayed the name of connecting audio device.

## **IPOD OPERATIONS**

Touch the icon "IPOD" to enter the IPOD Mode if iPod connected.  
The unit will switch to IPOD Mode automatically if connecting iPod.  
The unit will switch to RADIO Mode automatically if disconnecting iPod.

### **NOTE:**

***It is available for iPod operations with an additional iPod cable which is optional accessory.***

### **Music Operation**

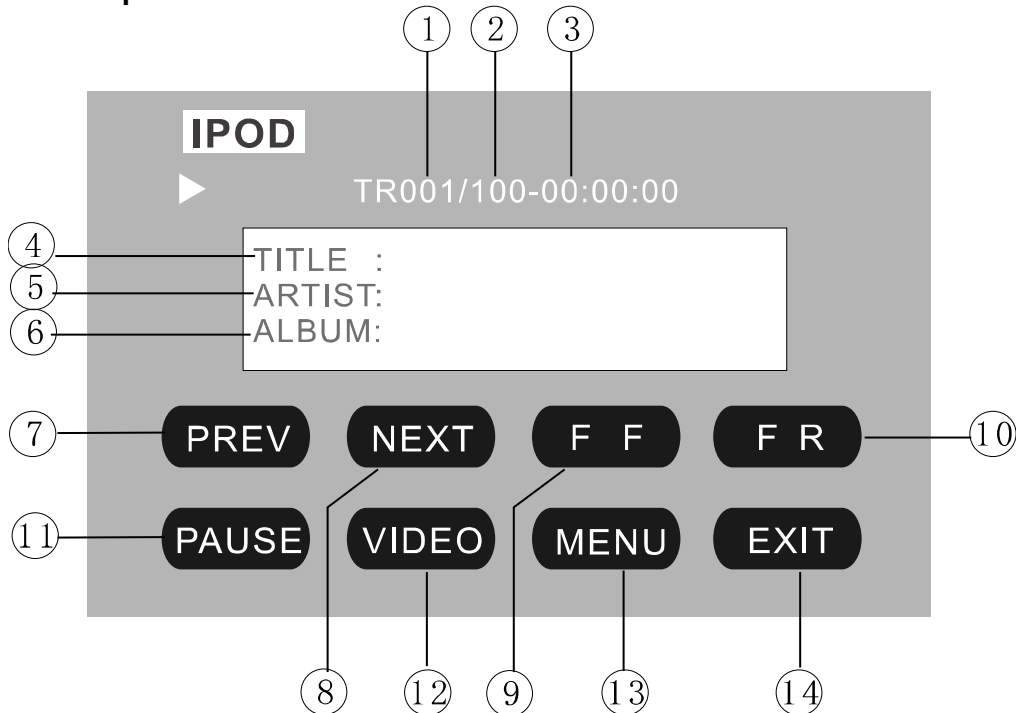

1. The Number of Playing Song
2. The Total Songs in Play List
3. The Playing Time
4. The Name of Playing Song
5. The Name of Artist
6. The Name of Album
7. PREV / 8. NEXT

Touch the icon to go to the pervious / next chapter, track or song.

To press the [PREVIOUS] / [NEXT] buttons of panel or remote control performs same operation.

9. F.REV / 10. F.FWD

Touch the icon to select fast reverse / forward search. Touch the [PLAY] to resume to normal playback.

To press the [F.REV] / [F.FWD] buttons of remote control performs the same operation.

11. PLAY / PAUSE

Touch the icon to play or pause the disc.

To press the [PLAY/PAUSE] button of panel or remote control performs the same operation.

## 12. VIDEO

Touch the icon to switch to the VIDEO operation.

## 13. MENU

Touch the icon to return the main menu.

## 14. EXIT

Touch the icon to exit the TOUCH ICONS display.

### Video Operation

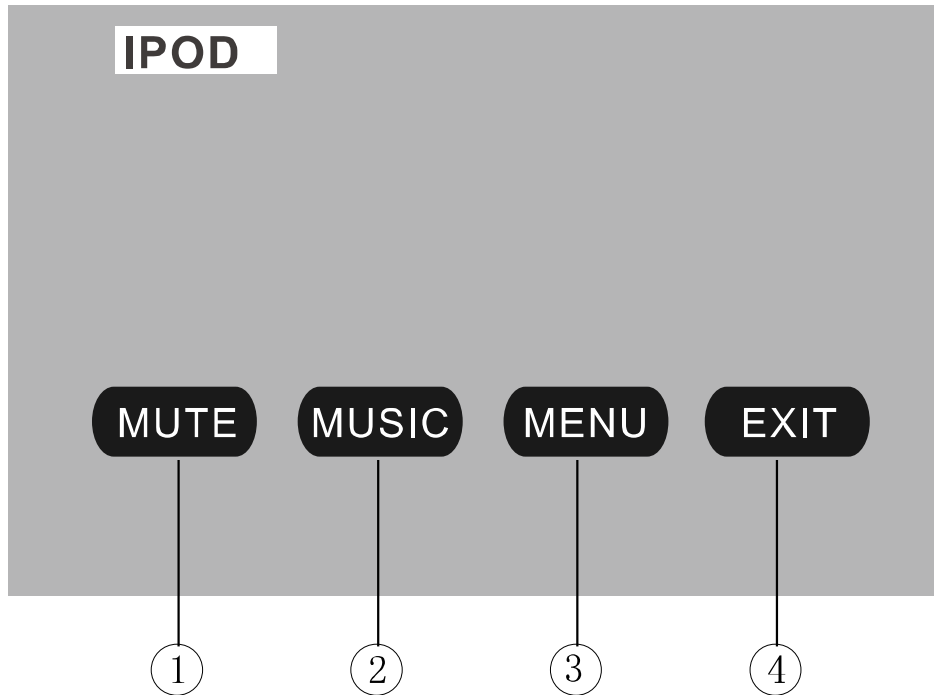

### 1. MUTE

Touch the icon to switch off the sound; touch it again to resume to the previous volume level.

### 2. MUSIC

Touch the icon to switch to the MUSIC operation.

### 3. MENU

Touch the icon to return the main menu.

### 4. EXIT

Touch the icon to exit the TOUCH ICONS display.

## **AV IN 1 OPERATIONS**

Touch the icon “AV IN 1” to enter the AV IN 1 Mode:

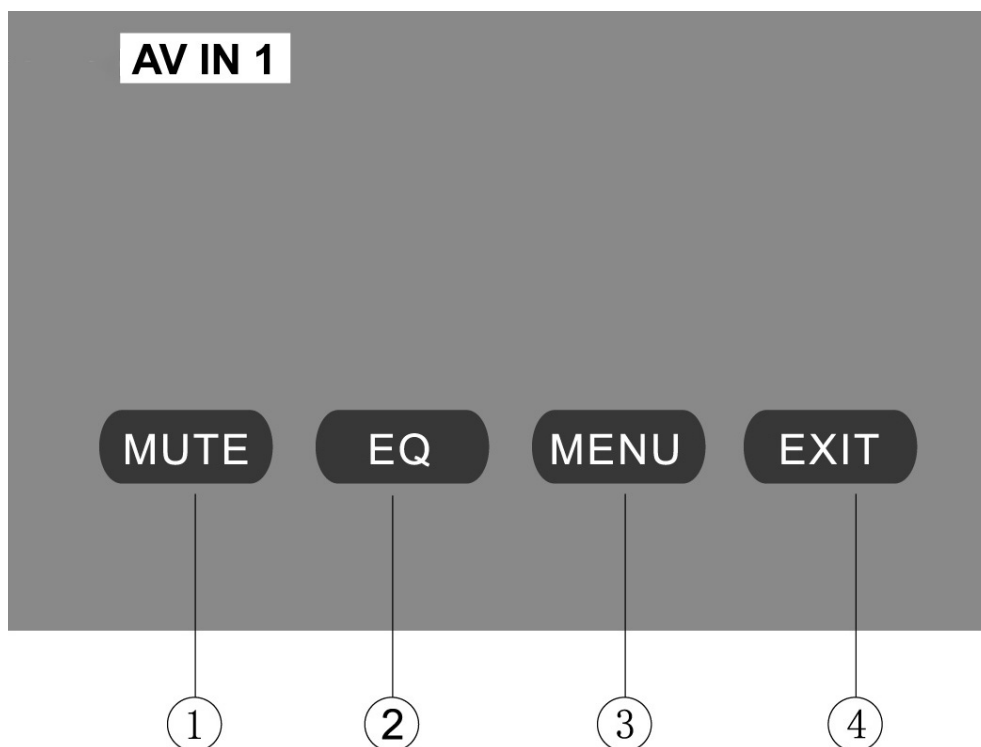

### **1. MUTE**

Touch the icon to switch off the sound; touch it again to resume to the previous volume level.

### **2. EQ**

The user can set to adjust the audio output to your preference:

**USER – POP – CLASSIC – ROCK – JAZZ – USER**

### **3. MENU**

Touch the icon to return the main menu.

### **4. EXIT**

Touch the icon to exit the TOUCH ICONS display.

### **NOTE:**

***AV IN 1 is for the RCA audio (L/R) & video input on rear panel of unit.***

## **AV IN 2 OPERATIONS**

Touch the icon "AV IN 2" to enter the AV IN 2 Mode:

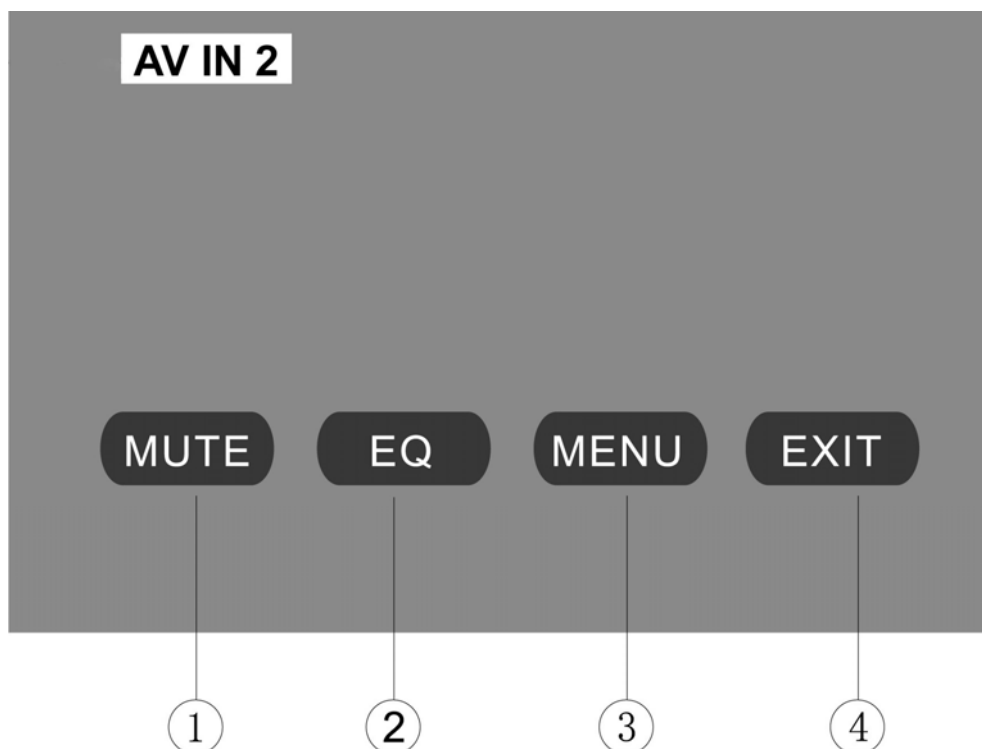

### **1. MUTE**

Touch the icon to switch off the sound; touch it again to resume to the previous volume level.

### **2. EQ**

The user can set to adjust the audio output to your preference:

**USER – POP – CLASSIC – ROCK – JAZZ – USER**

### **3. MENU**

Touch the icon to return the main menu.

### **4. EXIT**

Touch the icon to exit the TOUCH ICONS display.

### **NOTE:**

***AV IN 2 is for the audio (L/R) & video input jack on the right side of front panel (see item 11 in page 10). Connect an external audio/video device to AV IN 2 jack to listen to the device through your car speakers.***

## **CDC OPERATIONS**

Touch the icon "CDC" to enter the CDC Mode if CD/DVD changer connected:

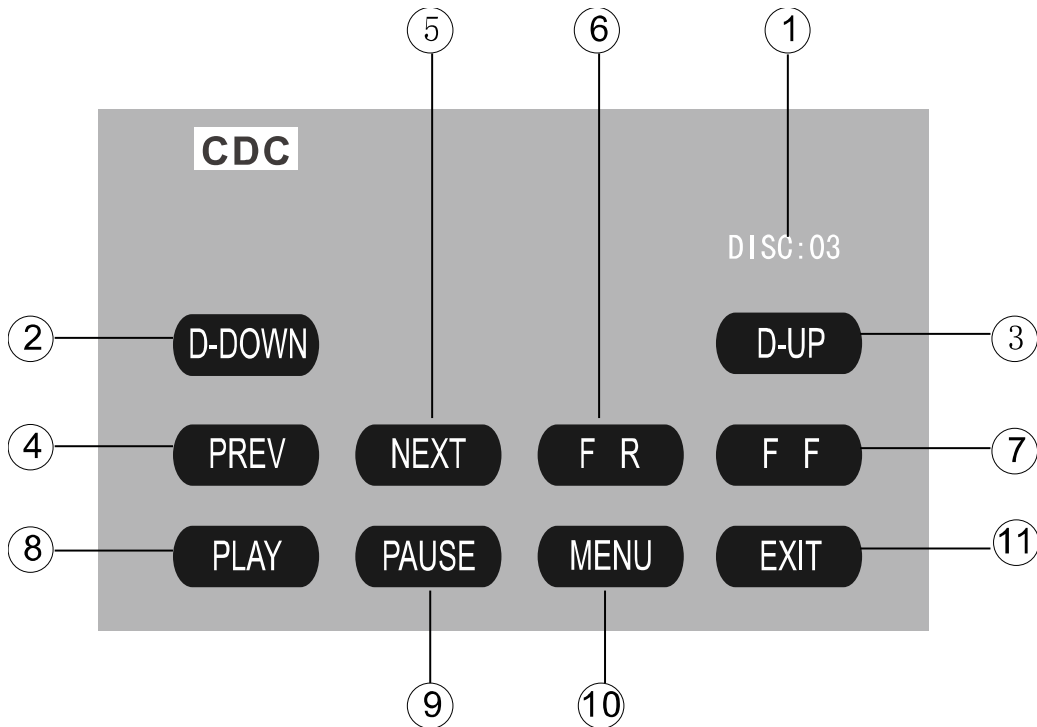

**1.** The playing DISC number

**2.** D-DOWN / **3.** D-UP

Touch the icon to change the next / previous disc to play.

**4.** PREV / **5.** NEXT

Touch the icon to go to the pervious / next chapter, track or song.

To press the [PREVIOUS] / [NEXT] buttons of panel or remote control performs same operation.

**6.** F.REV / **7.** F.FWD

Touch the icon to select fast reverse / forward search. Touch the [PLAY] icon to resume to normal playback.

To press the [F.REV] / [F.FWD] buttons of panel or remote control performs the same operation.

**8.** PLAY / **9.** PAUSE

Touch the icon to play or pause the disc.

To press the [PLAY/PAUSE] button of panel or remote control performs the same operation.

**10.** MENU

Touch the icon to return the main menu.

**11.** EXIT

Touch the icon to exit the TOUCH ICONS display.

**NOTE:**

Touch the “CDC” icon to enter the following page if the CD/DVD changer not connected.

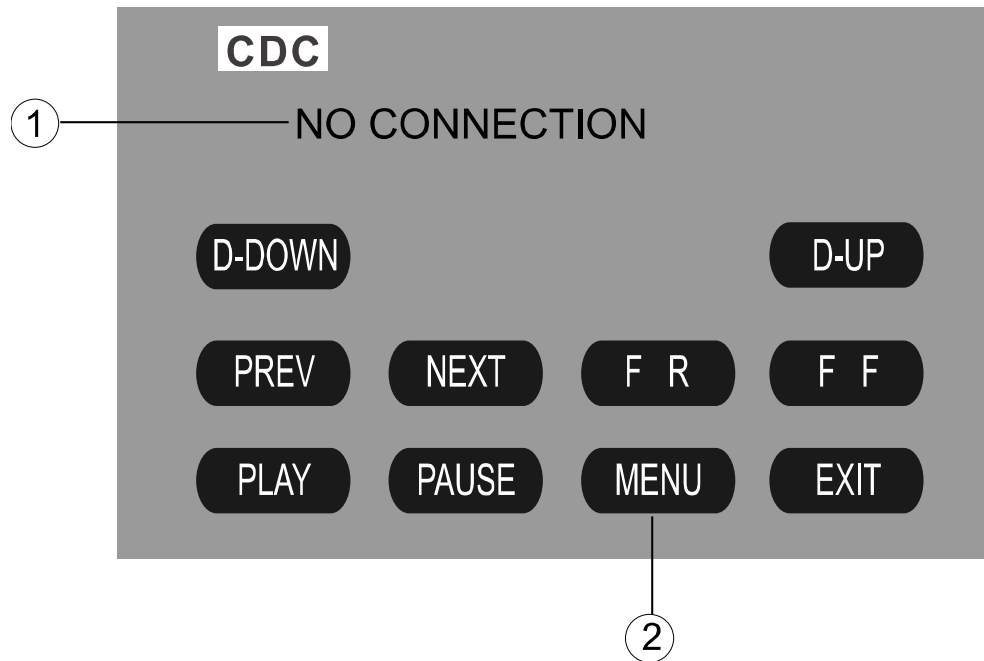

**1, INFORMATION**

It indicates that the unit does not connect the CD/DVD changer.

**2, MENU**

Touch the icon to return the main menu.

## **SYSTEM SETUP**

Touch the icon "SETUP" or press the [SYSTEM] button of panel to enter the SETUP of system parameters:

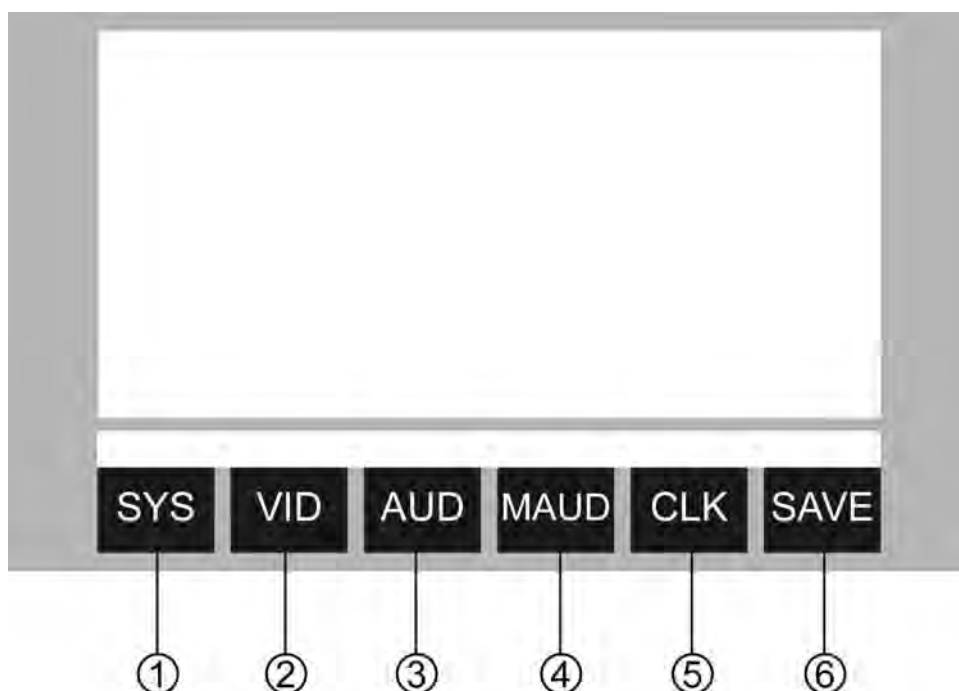

- 1. SYSTEM SETUP**
- 2. VIDEO SETUP**
- 3. AUDIO SETUP**
- 4. MORE AUDIO SETUP**
- 5. CLOCK SETUP**

Touch the icon 1~5 to select the main menus directly.

### **6. SAVE SETTINGS**

Touch the icon 5 to save all settings and exit SETUP.

## **SETUP MENU OPERATION**

Press the [ENTER / BAND] button of remote control to switch the main menus as following:

### **SYSTEM – VIDEO – AUDIO – MORE AUDIO – CLOCK – SYSTEM**

Press the [v] / [^] buttons of remote control to select the item you want to change.  
Press the [<] / [>] buttons of remote control to change the value of item.  
Holding on pressing the [SYSTEM] button of panel to exit SETUP of system parameters.

## SYSTEM SETUP

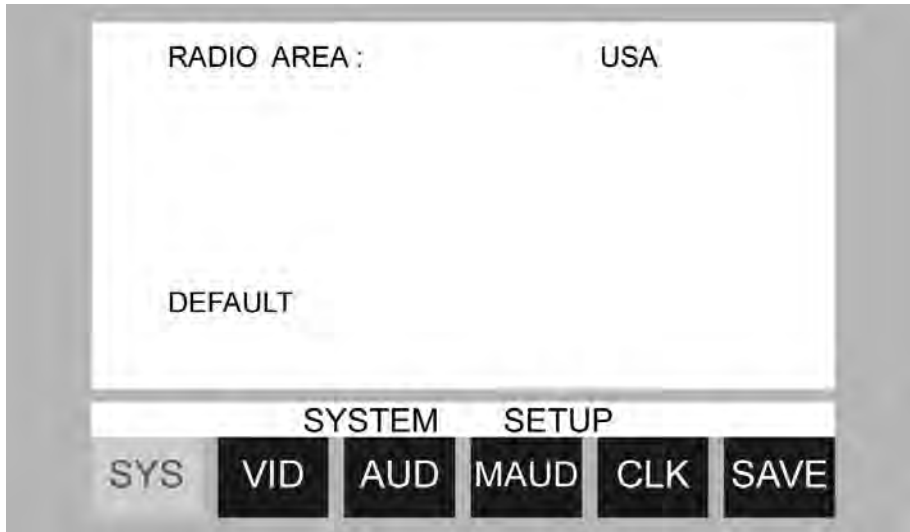

**RADIO AREA:** USA – JAPAN – OIRT – EUROPE – ASIA – USA

**DEFAULT:** the unit will restore all default settings of Sound Parameter, Picture Parameter & Tuner Parameter.

## VIDEO SETUP

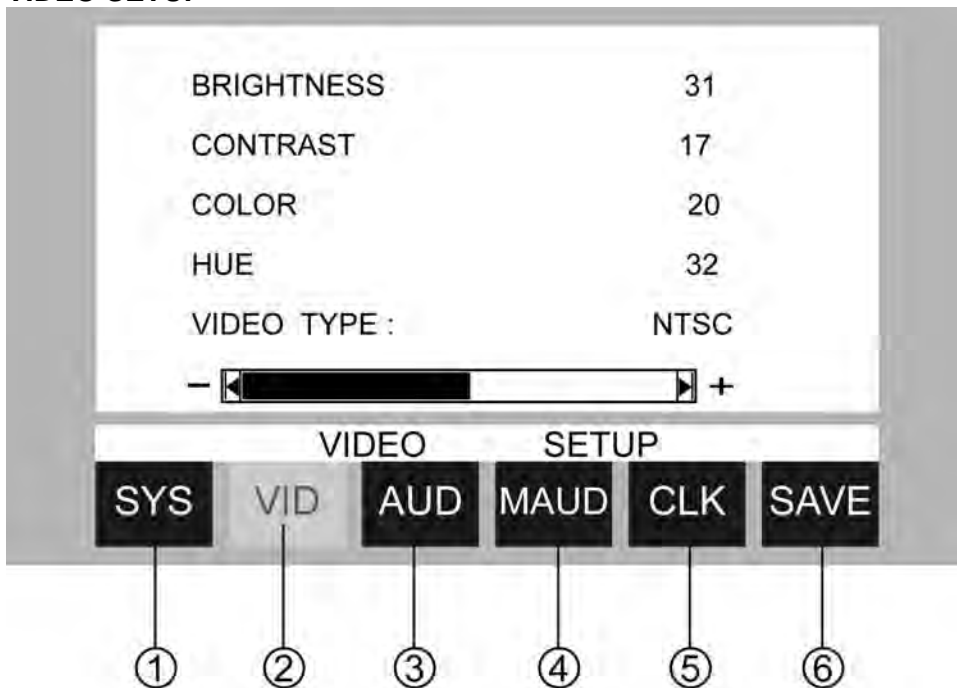

**BRIGHTNESS:** 0 ~ 64

**CONTRAST:** 0 ~ 64

**COLOR:** 0 ~ 64

**HUE:** 0 ~ 64

**VIDEO TYPE:** NTSC – PAL – AUTO – NTSC

### NOTE:

It is available to setup of HUE under NTSC VIDEO TYPE only.

## AUDIO SETUP

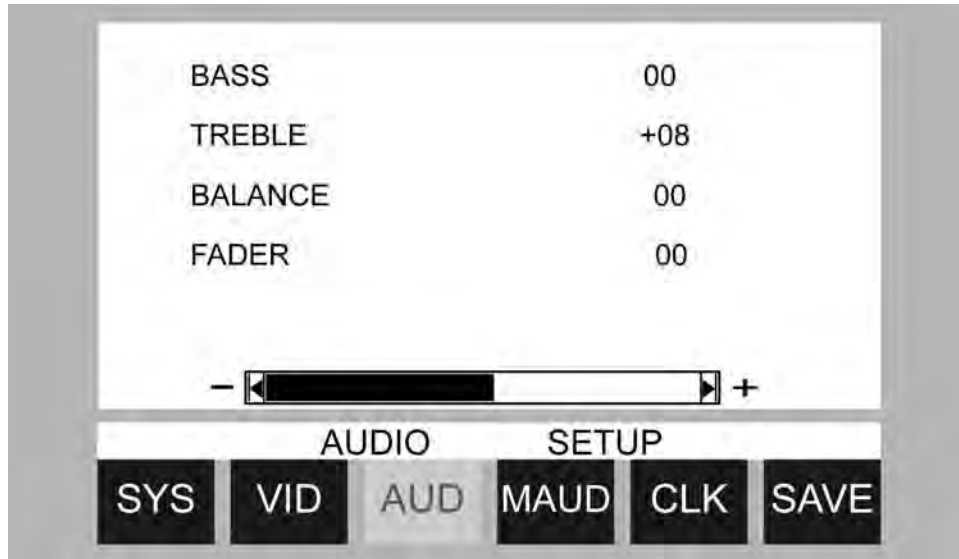

**BASS:** - 15 ~ + 15  
**TREBLE:** - 15 ~ + 15  
**BALANCE:** L 15 ~ R 15  
**FADER:** F 15 ~ R 15

## MORE AUDIO SETUP

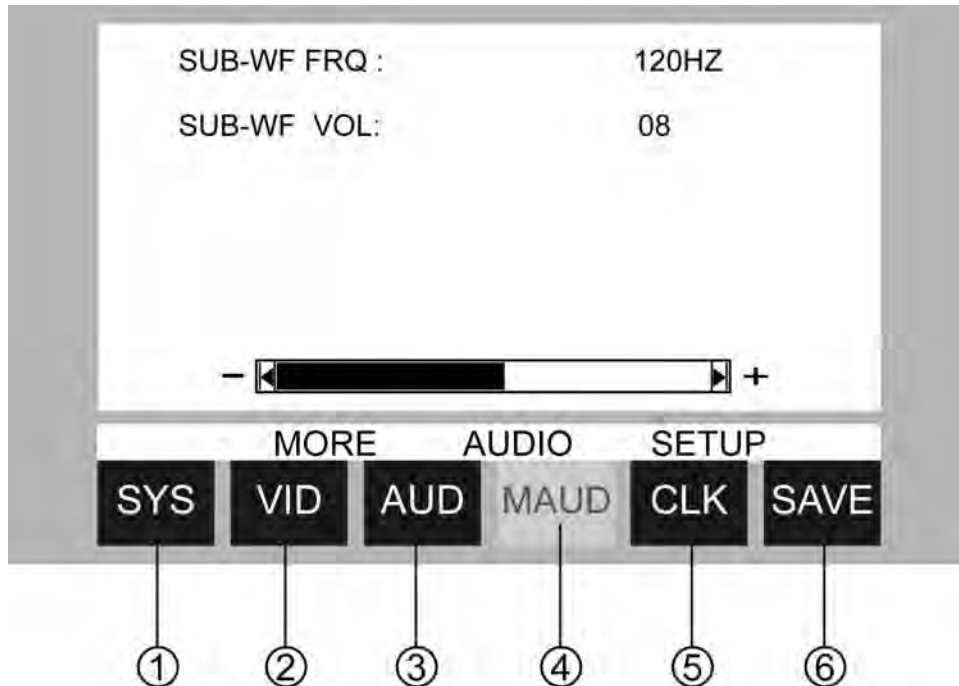

**SUB-WOOFER FRQ:** 80HZ – 120HZ – 160HZ – OFF – 80HZ  
**SUB-WOOFER VOL:** 0 ~ 15

## CLOCK SETUP

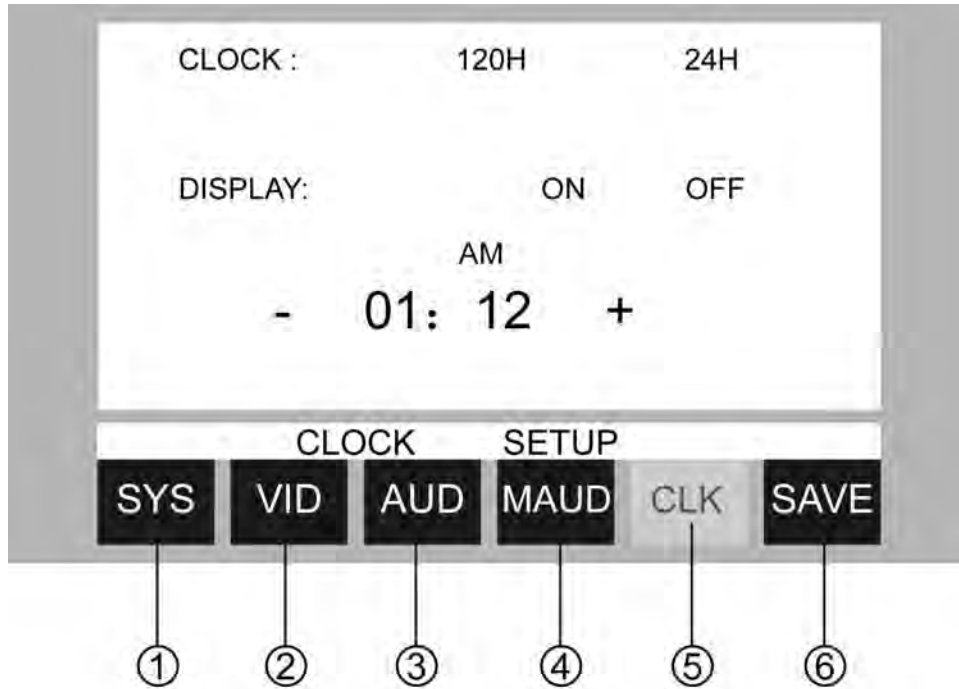

**CLOCK:** 12H / 24H  
**DISPLAY:** ON / OFF  
**HOUR:** 00 ~ 23  
**MINUTE:** 00 ~ 59

## DVD SETUP MENU

### SETUP MENU OPERATION

Press the [SETUP] button of remote control to enter the DVD SETUP Menu.

Press the [<] / [>] buttons to switch the main menus as following:

**SYSTEM – LANGUAGE – AUDIO – VIDEO – SPEAKER – DIGITAL**

Press the [^] / [v] buttons to enter the submenus from main menus.

Press the [^] button on the top submenu or press the [v] button on the bottom of submenu to exit the submenus to main menus.

Press the [^] / [v] buttons to select the submenus as your need.

Press the [>] or [ENTER] buttons to enter the items of submenus.

Press the [<] button to exit the items of submenus.

Press the [v] / [^] buttons to select the item you want to change.

Press the [ENTER] button to confirm the item you have selected and exit to the submenus.

Press the [SETUP] button of remote control or press the [ENTER] button on the submenu EXIT SETUP to exit the DVD SETUP Menu and save all settings.

### NOTE

*Effective only DVD, SD & USB Mode.*

## SYSTEM SETUP

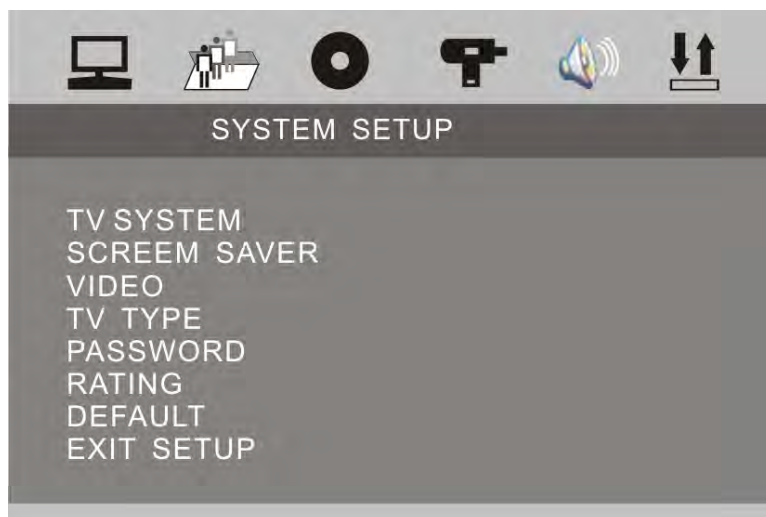

### TV SYSTEM

Following options are available for the TV Display:  
NTSC

### SCREEN SAVER

Select ON or OFF.

## VIDEO

Following options are available for the TV Display:

INTERLACE-YUV      TV-RGB      P-SCAN YPBPR      S-VIDEO

## TV TYPE

Following options are available for the TV Display:

4 : 3 PS      4 : 3 LB      16 : 9

## PASSWORD

Setup the password for Parental Ratings change. The default password is 0000.

## RATING

Following options are available for the Parental Ratings:

1 KID SAFE      2 G      3 PG      4 PG 13  
5 PG - R      6 R      7 NC - 17      8 ADULT

The Parental Ratings could be changed after the correct password input.

## DEFAULT

The unit will restore all default settings by selecting this option.

## LANGUAGE SETUP

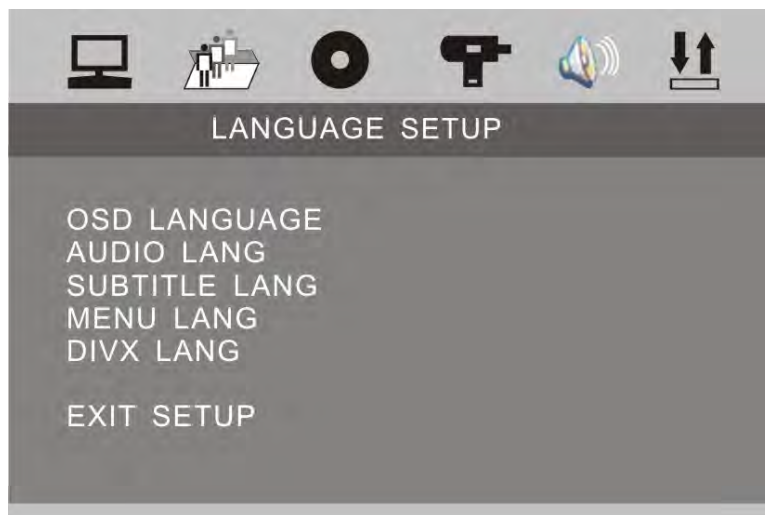

## OSD LANGUAGE

Following options are available for the OSD LANGUAGE:

ENGLISH      GERMAN      SPANISH      FRENCH      PORTUGUESE  
ITALIAN      RUSSIAN      DUTCH      SWEDISH      KOREAN  
DANISH      NORWEGIAN      POLISH      HUNGARIAN

## AUDIO LANGUAGE

Following options are available for the AUDIO LANGUAGE:

ENGLISH      GERMAN      SPANISH      FRENCH      PORTUGUESE  
ITALIAN      RUSSIAN      DUTCH      SWEDISH      KOREAN  
DANISH      NORWEGIAN      POLISH      HUNGARIAN

### **SUBTITLE LANGUAGE**

Following options are available for the SUBTITLE LANGUAGE:

ENGLISH	GERMAN	SPANISH	FRENCH	PORTUGUESE
ITALIAN	RUSSIAN	DUTCH	SWEDISH	KOREAN
DANISH	NORWEGIAN	POLISH	HUNGARIAN	

### **MENU LANGUAGE**

Following options are available for the MENU LANGUAGE:

ENGLISH	GERMAN	SPANISH	FRENCH	PORTUGUESE
ITALIAN	RUSSIAN	DUTCH	SWEDISH	KOREAN
DANISH	NORWEGIAN	POLISH	HUNGARIAN	

### **DIVX LANGUAGE**

Following options are available for the DIVX LANGUAGE:

CENTRAL	EU
WESTERN	EU
KOREAN	

### **AUDIO SETUP**



### **AUDIO OUT**

Following options are available for the AUDIO OUT:

SPDIF / OFF	SPDIF / RAW	SPDIF / PCM
-------------	-------------	-------------

### **KEY**

Following options are available for the KEY:

b	-4	-2	0	+2	+4	#
---	----	----	---	----	----	---

## VIDEO SETUP

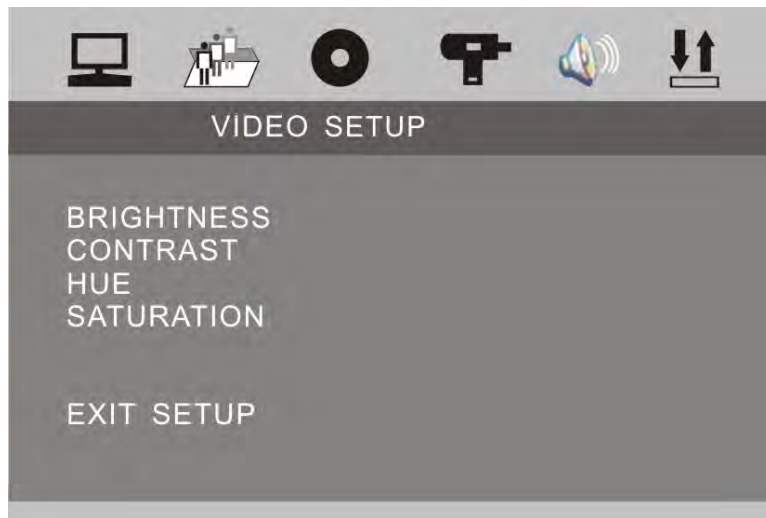

### **BRIGHTNESS**

Following options are available for the BRIGHTNESS:

0 2 4 6 8 10 12

### **CONTRAST**

Following options are available for the CONTRAST:

0 2 4 6 8 10 12

### **HUE**

Following options are available for the HUE:

-6 -4 -2 0 +2 +4 +6

### **SATURATION**

Following options are available for the SATURATION:

0 2 4 6 8 10 12

## SPEAKER SETUP

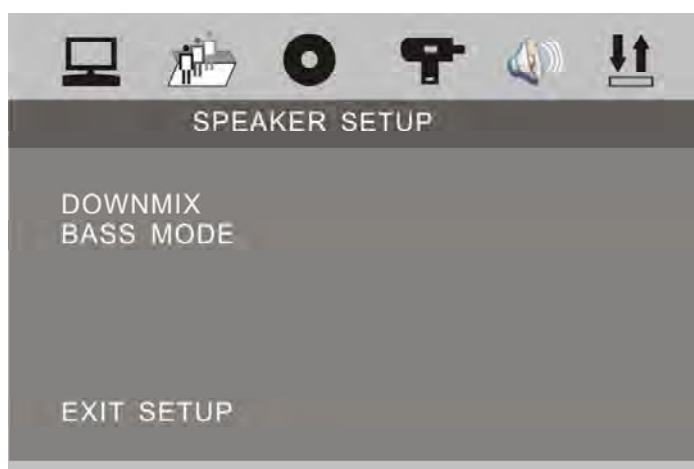

**DOWNMIX**

Following options are available for the DOWNMIX:  
LT / RT      Stereo      VSS

**BASS MODE**

Following options are available for the BASS MODE:  
ALL LG SPK      ALL SM SPK      MIXED SPK

**DIGITAL SETUP**



**OP MODE**

Following options are available for the OP MODE:  
LINE OUT      RF REMOD

**DYNAMIC RANGE**

Following options are available for the DYNAMIC RANGE:  
FULL      6 / 8      4 / 8      2 / 8      OFF

**DUAL MONO**

Following options are available for the DUAL MONO:  
STEREO      MONO L      MONO R      MIX MONO

## TROUBLE SHOOTING

If any of problem persists after checking the below list, Please consult your nearest service dealer.

Never attempt to disassemble and repair unit personally.

<b>Problem</b>	<b>Cause</b>	<b>Corrective Action</b>
<b>GENERAL</b>		
Unit will not power on	ACC Fuse blown Car battery fuse blown illegal operation	Install new fuse with correct rating Install new fuse with correct rating Press the RESET button located in the bottom right corner of the front panel
Remote control does not work	Battery depleted Battery installed incorrectly	Replace battery with new one Remove battery and install correctly
No/low audio output	Improper audio output connection Volume set too low Speakers damaged Heavily biased volume balance Speakers wiring is in contact with metal Part or car	Check wiring and correct Increase volume level Review wiring diagram and check MUTE connection Replace speakers Adjust the channel balance to the center position Insulate all speaker wiring connections
Poor sound quality or distortion	Pirate disc is in use Speaker power rating not compatible with unit Speaker is shorted	Use original copy Connect proper speakers Check speaker contact
Unit resets itself when engine is off	Incorrect connection between ACC and Positive battery wire	Check wiring and correct
<b>TUNER</b>		
Weak station searching	Auto antenna is not fully extended Auto antenna not properly connected LOCAL function is activated	Connect the auto antenna control cable properly Connect the auto antenna control cable properly Turn LOCAL function off
<b>TFT MONITOR</b>		
No image	Incorrect connection to parking brake wire PARKING is activated and parking brake is not engaged	Check wiring and correct Stop vehicle in safe place and apply parking brake
Flashing image or interference appears on screen	DVD is not compatible with current TV system settings Image blurred, distorted, or dark	Change setup to accommodate disc
Prolonged image or improper height/width ratio display	Improper video signal connections Improper aspect ratio setup	Check wiring and correct Use correct aspect ratio setting

<b>Problem</b>	<b>Cause</b>	<b>Corrective Action</b>
----------------	--------------	--------------------------

<b>VCD</b>		
Cannot insert disc	Disc already inside unit	Eject current disc and insert new one
Disc does not play back	Disc is warped or scratched Disc is dirty or wet Incompatible disc is used Disc rating exceeds Parental Lock rating limit Disc region code is not compatible with unit Disc is inserted upside down	Use disc in good condition Clean disc with soft cloth Use compatible disc Change parental Lock settings to lower restriction Use compatible disc Change Parental Lock settings to lower restriction Use disc with proper region cod Insert disc with label side up
Image blurred , distorted, or dark	Disc is illegally copied	Use original disc
PBC cannot be used during VCD playback	PBC is not available on the disc	
No repeat or searching while playing VCD	PBC is on	Turn PBC off
<b>MP3</b>		
Interruption occurred during playback	Disc is dirty or scratched	Clean disc or replace
Cannot read disc	File is damaged/bad recording	Recreate disc with good files
Incorrect playback message displayed	Message is longer than LCD can display	

### Error Messages

Message Displayed	Cause	Corrective Action
Loading	Disc is being read	
No disc	Disc is dirty	Clean disc with soft cloth
	Disc is upside down	Insert disc with label side up
	Disc not present in loading compartment	Insert disc
Bad Disc	Disc is dirty	Clean disc with soft cloth
	Disc is upside down	Insert disc with label side up
Unknown disc	Disc format is not compatible with this unit	
Region Error	DVD is not compatible with region code of unit	
Error	illegal mechanism operation	Press EJECT key for 5 seconds to reset loading mechanism

## **SPECIFICATIONS**

### **GENERAL**

Supply Voltage	: 14.4 V DC (10.8-16 V DC Allowable)
Load Impedance	: 4 $\Omega$
Max Power Output	: 50 W x 4
Bass 100Hz	: $\geq$ 10dB
Treble 10KHz	: $\geq$ 10dB
Dimension (approx)	: 187 x 188 x 110 mm (d/w/h)
Mounting (approx)	: 160 x 178 x 100 mm (d/w/h)

### **FM TUNER**

Frequency Range	: 87.5-107.9 MHz (USA) : 87.5-108.0 MHz (Europe/China)
IF	: 10.7 MHz
Usable Sensitivity	: $\leq$ 15 dB $\mu$ V
Stereo Separation	: $\geq$ 27 dB(1KHz)
Frequency Response	: 20-10000 Hz

### **AM TUNER**

Frequency Range	: 530-1710 KHz (USA) : 522-1620 KHz (Europe) : 531-1602 KHz (China)
IF	: 450 KHz
Usable Sensitivity	: $\leq$ 34 dB $\mu$ V

### **DVD PLAYER**

Signal System	: PAL/NTSC
Signal-to-noise Ratio	: $\geq$ 80 dB(1KHz)
Distortion	: $\leq$ 0.5%

### **MONITOR**

Resolution	: 1440 (w) x 234 (H) (RGB)
Brightness	: 350 cd/m <sup>2</sup>
Contrast	: 300:1

### **NOTE:**

Specifications and design are subject to modification without notice due to improvements in technology.

## DISC NOTES

- Disc formats supported by this player



### Handling and Cleaning

- Dirty, dusty, scratched or warped discs will cause misoperation.
- Do not place stickers or make scratches on discs.
- Do not warp discs.
- A disc should always be kept in its case when not in use to prevent from damage.
- Do not place discs in the following places:
  1. Direct sunlight.
  2. Dirty, dusty and damp areas.
  3. High temperature places.
  4. On the seats or dashboard.

### Disc Cleaning

Use a dry soft cloth to wipe the surface. If the disc is quite dirty, use a soft cloth slightly moist with isopropyl (rubbing) alcohol. Never use solvent such as benzene, thinner or conventional record cleaners which may mar the surface of the disc.

### NOTE:

A disc may become somewhat scratched (although not enough to make it unusable) depending on your handling it in the condition of the usage environment. These scratches are not an indication of any problem with the player.

### Repairing New Discs with Rough Spots

A new disc may have rough edges on its inside and outside edges. If a disc with rough edges is used, the proper setting will not be performed and the player will not play the disc. Therefore, remove the rough edges in advance by using a ballpoint pen or pencil. To remove the rough edges, press the side of the pen or pencil against the inside and outside edges of the disc.

