

7" Wide Touch Screen

In-Dash Fully Motorized TFT Monitor /DVD/AM/FM

Bluetooth Function

Operating manual

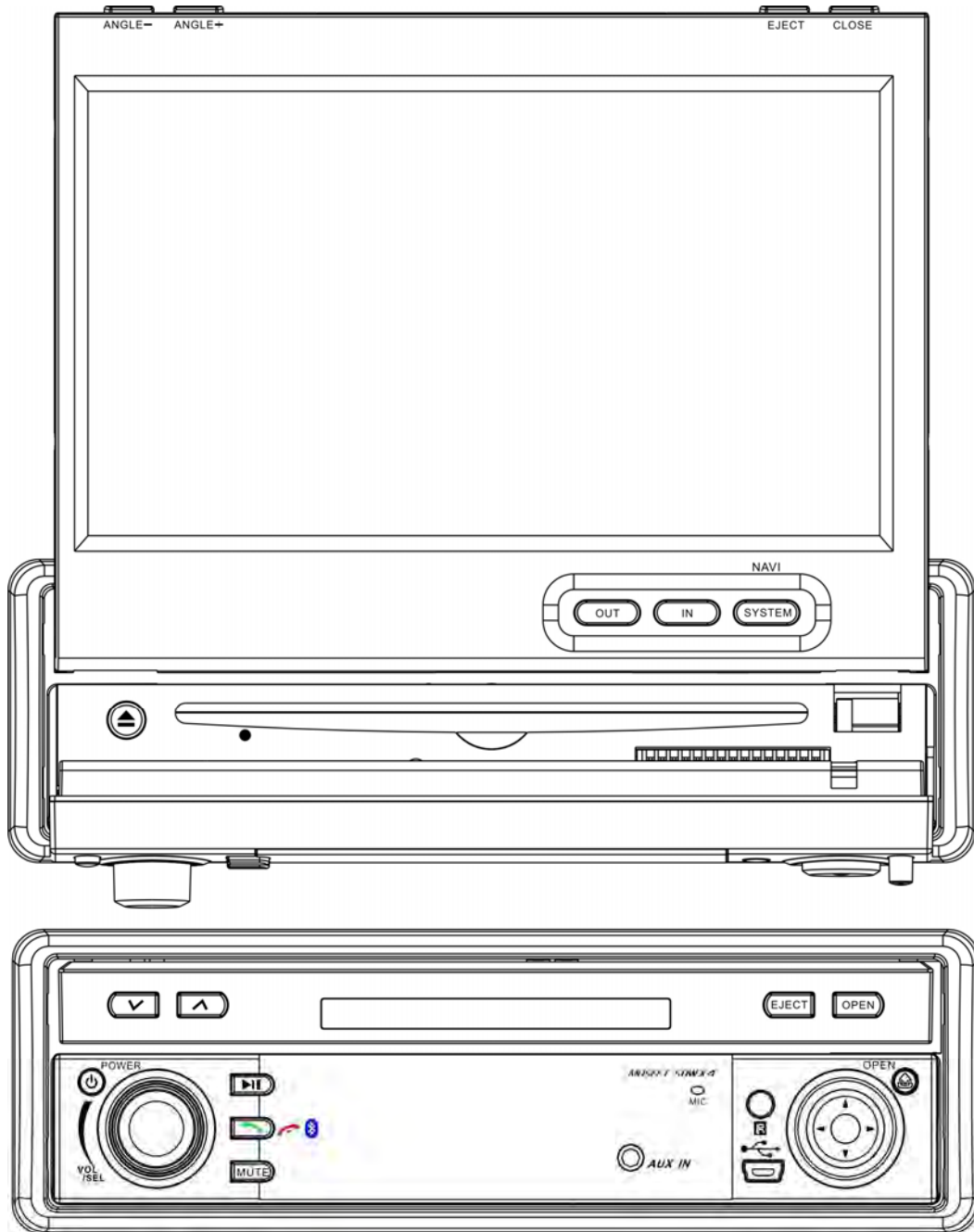

SAFETY INFORMATION

PLEASE READ COMPLETELY AND BECOME FAMILIAR WITH THE CONTENTS OF THIS MANUAL BEFORE INSTALLATION AND OPERATION OF THIS UNIT, AND KEEP IT CAREFULLY FOR FUTURE REFERENCE.

This unit is a class 1 laser product. The laser beam may cause hazardous radiation if exposure to laser system directly. Do not attempt to disassemble the unit personally.

This unit has been designed and manufactured to assure personal safety. Improper use can result in electric shock or fire hazard. The safeguards incorporated in this unit protect you if you observe the following procedures for installation, use and servicing. This unit doesn't contain any parts that can be repaired by the user. If the unit requires maintenance, contact an authorized service center.

Warnings

- Do not expose the product to rain, water or excessive moisture. This could cause electrical shorts, fire or other damage.
- This product is designed to operate with a 12 volt DC, negative ground battery system. Use the proper power supply.
- The monitor is operated automatically. Do not push in or pull out the monitor or try to reverse the monitor manually! Do not attempt to adjust the monitor angle upward or downward manually. It will cause damage to the Monitor Mechanism Structure.
- Do not impact the monitor with a hard object. It may cause permanent damage.
- Do ground all equipments and works in order to avoid causing damage to the unit by electrostatic discharges.
- The user who handles this product takes all necessary precautions to avoid ESD (Electro-Static Discharge) failures.
- Do not attempt to install or service your unit by yourself. Installation or servicing of the unit by persons without training and experience in electronic equipment and automotive accessories may be dangerous and could expose you to the risk of electric shock or other hazards.

Cautions:

- ① To reduce the risk of fire or electric shock, and annoying interference, use only the recommended accessories.
- ① While driving, keep the volume level low enough to be aware of road and traffic conditions.
- ① Parking in direct sunlight can produce very high temperatures inside your vehicle. Give the interior a chance to cool down before starting playback.
- ① Do not use any chemical solvent, cleaning agent or corrosive detergent to clean away dirt on the surface of the TFT monitor screen. It may cause irreversible damage.
- ① Small black and shiny dots inside the liquid crystal panel are normal for liquid crystal product.
- ① In extremely cold temperatures, the movement of the picture may be slow and the picture may be dark, but this is not a malfunction. The unit will work normally once reach its operating temperature.
- ① Do not use and store the unit in dusty, high temperature and high humidity environments.
- ① Do not use the unit immediately when you bring it from cold to warm place. Fast growing temperature, may cause moisture condensing which influence the unit for certain time.

NOTE:

- ① **This user's manual only for reference.**
- ① **Modifying rights are reserved.**
- ① **Modifications are subject to change without notice.**

FEATURES

- Fully Motorized Screen Telescopes Out And Up Including Front To Back Angling
- (Optional) Navigation Black Box Module With Navteq Maps Of North America
- Drop Down Detachable Front Panel For Invisible DVD Insertion Slot
- Electronic Touch Screen Functions Include DVD, Radio, USB, & MP-3/4
- Front Panel Display When The Monitor Is Closed
- Electronic Touch Screen Functions Include OSD Functions
- DVD/DVD-RW/CD/CD-R/CD-RW/MP-3/MP-4/Divx
- Menus Can Be Displayed On Screen Via OSD (Fourteen Languages)
- 30-Second Electronic Anti-shock Mechanism
- Accessory iPod Input Connection (Cable Not Included)
- USB Mini Input For Mp-3 Music, Divx, Xvid & Mp-4 Movies
- IR Repeater For External Remote Eye
- Antenna Trigger Wire
- Amplifier Trigger Wire
- Brake Screen Safety Trigger
- AM/FM With 30 Pre-sets (18/FM - 12AM)
- Auto Store Pre-set Scan
- 4-Channel High Power 50 X 4 Channels (Mosfet Power)
- Dual RCA Outputs (Front & Rear)
- Sub Woofer Selectable Frequency Outputs (80, 120, 160Hz)
- Variable Sub Woofer Volume Control
- 1-Auxiliary Video Input For Back-up Camera
- 1-A/V In For Secondary Source Input
- 1-RCA Video Output
- LO/DX And Stereo Mono Selector Switch
- Electronic (Bass, Treble, Volume, Balance, Fader)
- Pre-set EQ Functions (Rock, Pop, Classic, Jazz, User)
- Digital Clock
- DVD, PAL/NTSC Selectable
- USA/EUROPE Frequency Stepping
- Resolution: 1440 X 234
- Panel Brightness: 350 NIT
- ISO/DIN
- Full Function Remote Control
- Last Position DVD Memory
- Bluetooth Function
- Improved Graphic User Interface

TABLE OF CONTENTS

Safety Information.....	1
Features.....	3
Table of Contents.....	4
Accessories.....	5
Unit Installation.....	6
Unit Removal.....	8
Wiring Connection.....	9
Front Panel.....	12
Remote Control.....	17
Basic Operation.....	22
Touch Screen Operations.....	24
Touch Screen Calibrate.....	24
Main Menu.....	25
Radio Operations.....	26
DVD Operations.....	29
USB Operations.....	31
Bluetooth Operations	32
iPod Operations.....	40
AV IN Operations.....	42
AUX Operations.....	43
NAVI Operations.....	44
System Setup.....	48
DVD Setup Menu.....	52
Trouble shooting.....	58
Specifications.....	61
Disc Notes.....	62

ACCESSORIES

1

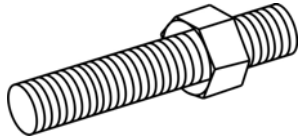

Bolt

2

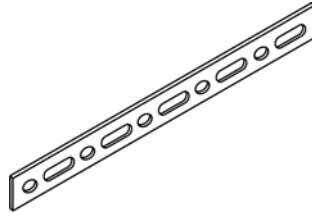

Steel Bar x 1

3

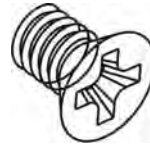

M5X5 Screws x 4

4

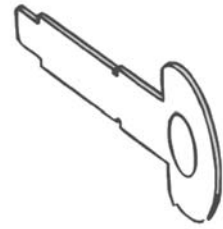

Keys x 2

5

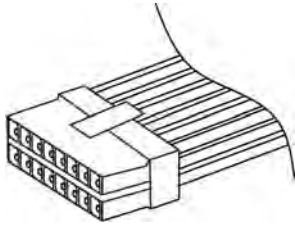

Connector Wire x 1

6

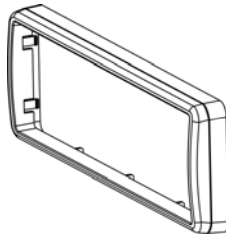

Trim Bezel x 1

7

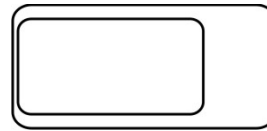

Remote Control x 1

8

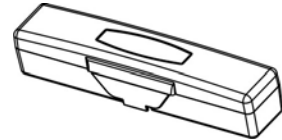

Box x 1

9

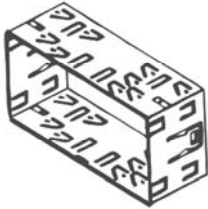

Mounting Sleeve x 1

10

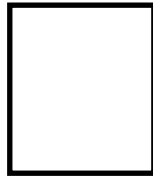

Operational Manual x 1

11



Nut M5 x 1

12



USB Cable x 1

13

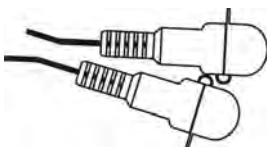

AUX Cable x 1

14



External Microphone x 1

15



SD Card Adapter x 1

16



iPod Cable x 1 (option)

UNIT INSTALLATION

Please read all of the instructions before beginning the installation. Recommend having your unit installed by a professional installation shop.

Tools and Supplies:

You will need these tools and supplies to install your unit:

- Torx type, flat-head and Philips screwdrivers
- Wire cutters and strippers
- Tools to remove existing radio (screwdriver, socket wrench set or other tools)
- Electrical tape
- Crimping tool
- Volt meter/test light
- Crimp connections
- 16 gauge wire for power connections
- 8 gauge speaker wire

Warnings:

Choose the mounting location where the unit will not interfere with the safe driving conditions.

Install the unit where it does not get in the driver's way and can not injure the passenger if there is a sudden stop, like an emergency stop.

Avoid installing the unit where it would be subject to high temperature, such as from direct sunlight, or from hot air, from the heater, or where it would be subject to dust, dirt or excessive vibration.

Cautions:

Before finally installing the unit, connect the wiring temporarily and make sure it is all connected up properly, the unit and the system work properly.

Use only the parts included with the unit to ensure proper installation. The use of unauthorized parts can cause malfunctions.

Consult with your nearest dealer if installation requires the drilling of holes or other modifications of the vehicle.

If installation angle exceeds 30 degrees from horizontal, the unit might not give its optimum performance.

● Securing the Unit to the Mounting Bracket.

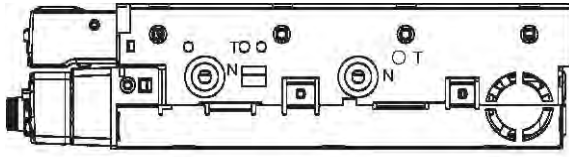

Installation Method

1. Install the front panel into the unit.

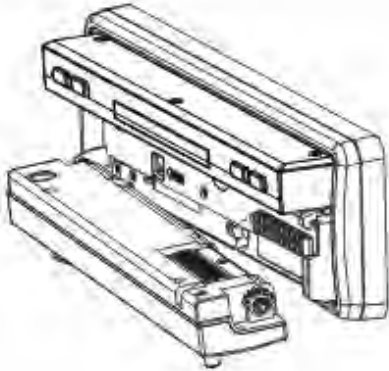

2. Bend the claws outward for tight fit, if necessary. Install the Mounting Box into the dashboard, tighten the unit in place.

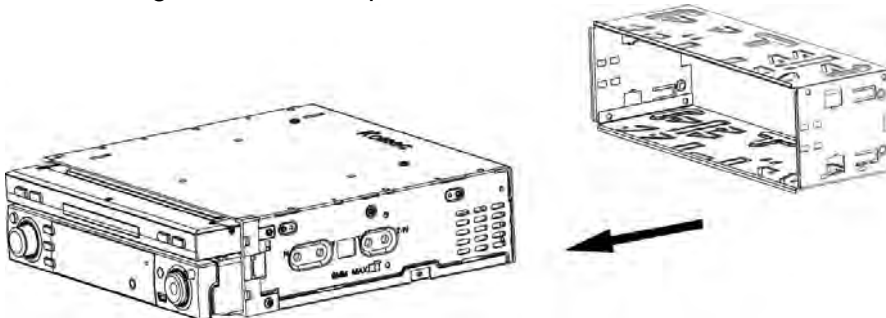

3. Install the Frame to the unit.

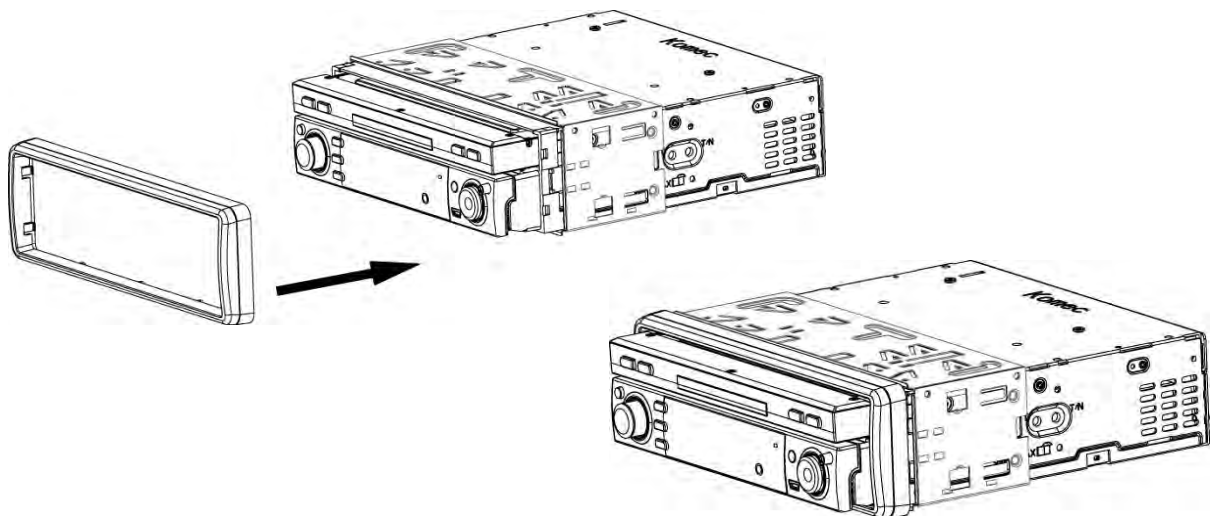

UNIT REMOVAL

1. Detach the front panel.

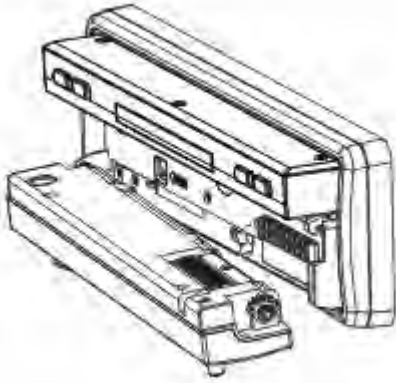

2. Insert the keys that supply to the unit at both sides of the unit (shown as illustrated) until pull the keys to make it possible to remove the unit from the dashboard.

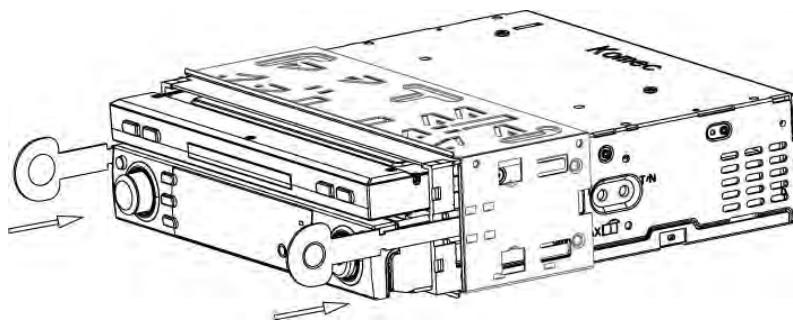
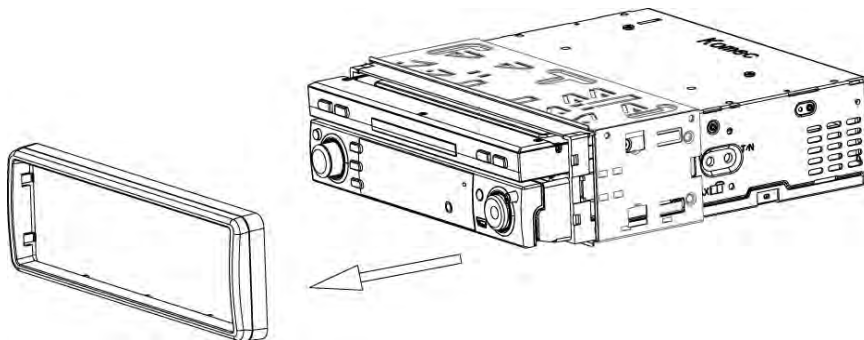

WIRING CONNECTION

Cautions:

- To prevent short circuits, remove the key from the ignition and disconnect the terminal of the battery.
- Make the proper input and output cable connections for each unit.
- Connect the wiring harness cables in the following order: ground wire, battery wire, ignition wire.
- Reconnect the terminal of the battery.
- Do not connect the yellow wire of this product directly to the battery terminal.
- Do remember to connect the red wire of this product to the ACC. of the ignition key switch. Failure to do may result in draining off the battery charge prematurely.
- If the fuse blows, first make sure that the cables have not caused a short circuit, then replace the old fuse with new one with the same rating.
- Do not let unconnected cables or terminals touch the metal on the car or other conductor.
- To prevent short circuits, do not remove the caps from unused terminals or from the ends of the unconnected cables.
- After the monitor unit is installed, check whether the brake lamps, blinkers, wiper, etc. on the vehicle are working properly. If not, please make sure they are proper installed.
- Insulate unconnected wires with vinyl tape or other similar material.

Disconnecting the Battery

To prevent a short circuit, be sure to turn off the ignition and remove the negative (-) battery cable prior to installation.

Reconnecting the Battery

When wiring is complete, reconnect the battery negative terminal.

Warning:

Be sure to use the correct type and amperage Fuse to avoid damaging the unit.

Fuse of the Battery wire in Main Unit: 1 amp;

Fuse of the ACC wire in Main Unit: 1 amp;

Wiring Diagram

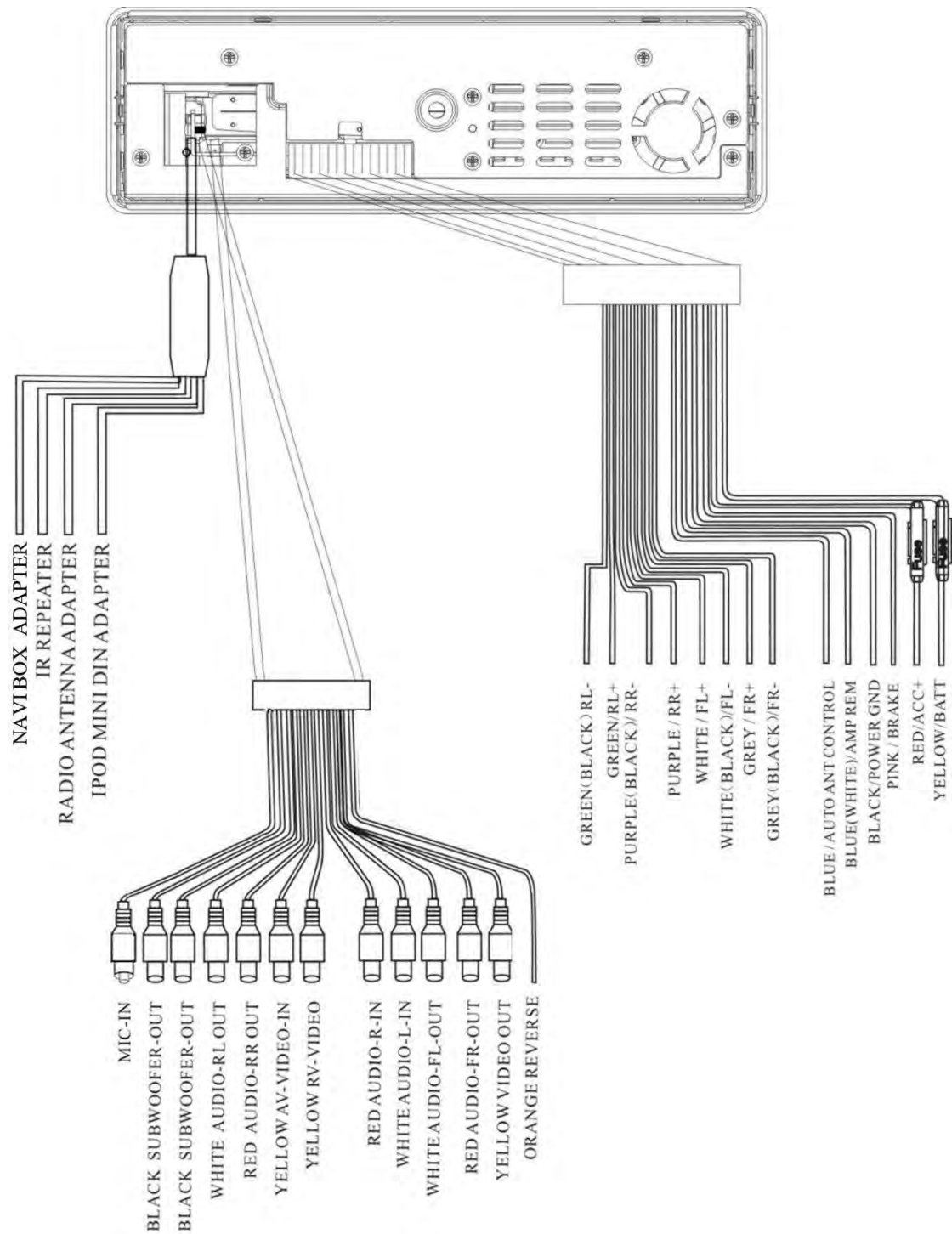

NOTE:

- 1, Plug the external microphone input into the MIC-IN jack for Bluetooth.
- 2, Please separate Battery Units before setting products to prevent from fire and electric shock. Mounting the antenna near to a radio antenna will result in noise. In this case, consult your dealer concerning mounting location.

Wiring Diagram

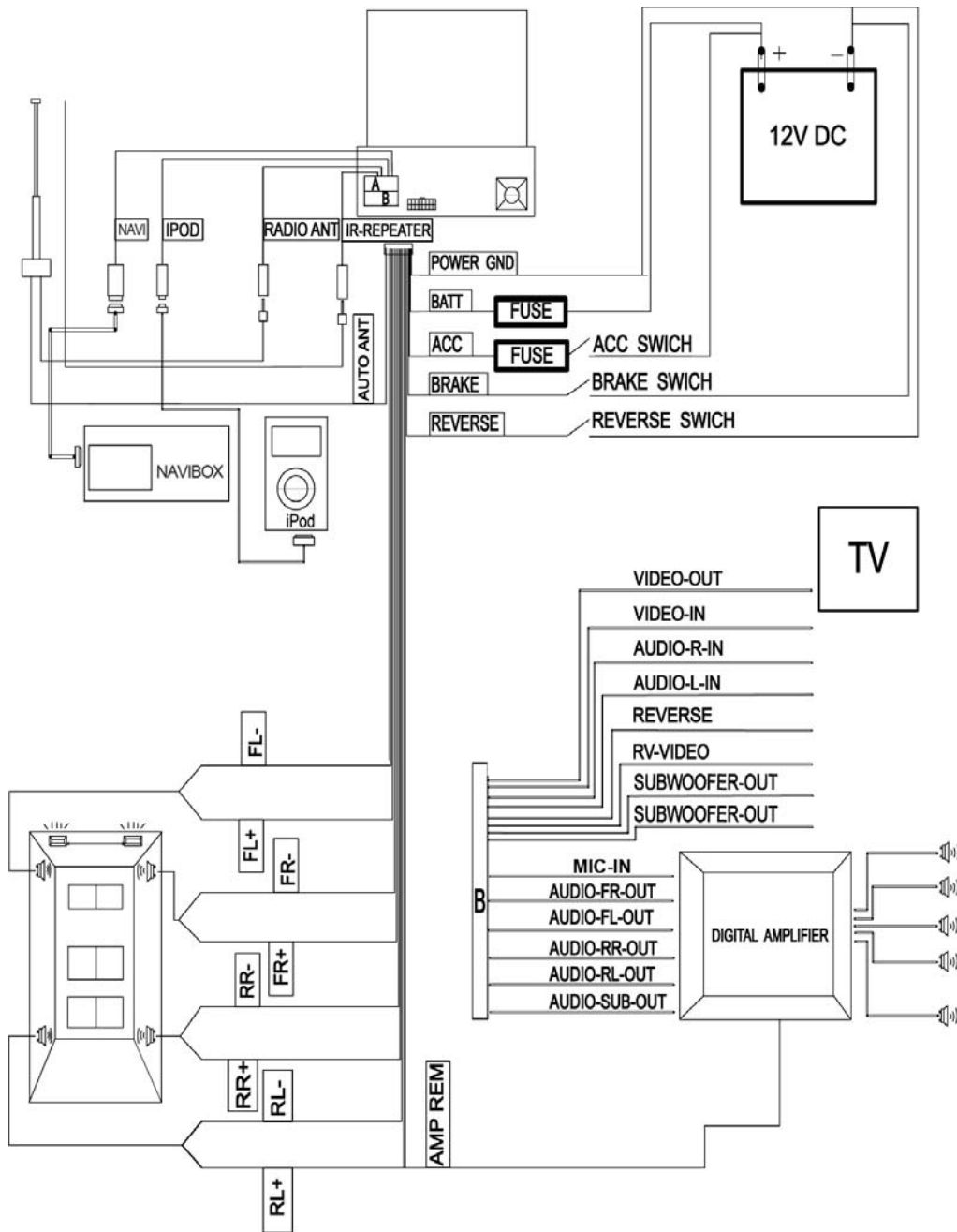

FRONT PANEL

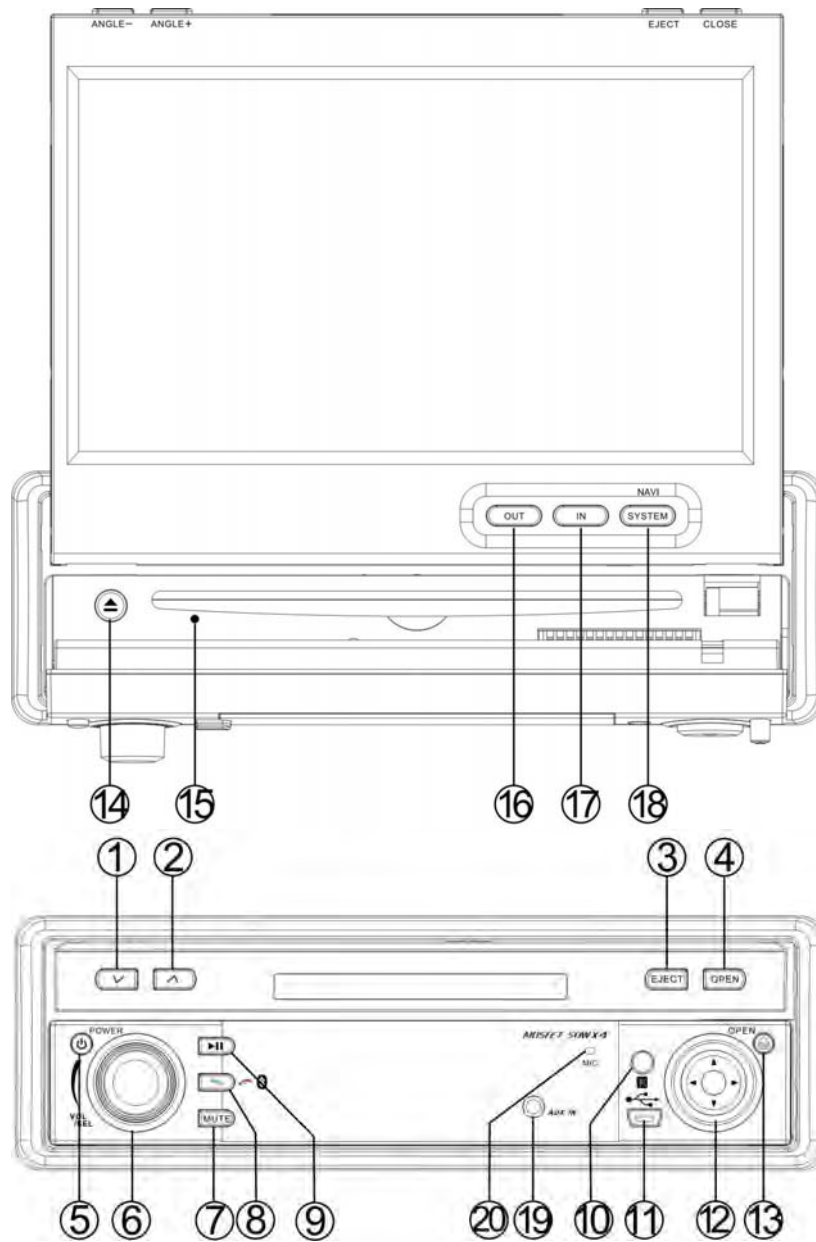

- | | |
|------------------------|---|
| 1. ANGLE - | 11. MINI USB |
| 2. ANGLE + | 12. LEFT / UP / RIGHT / DOWN / ENTER / BAND |
| 3. EJECT | 13. REL |
| 4. OPEN / CLOSE | 14. EJECT |
| 5. POWER / SOURCE | 15. RESET |
| 6. VOLUME / MENU / SEL | 16. OUT |
| 7. MUTE | 17. IN |
| 8. CALL / TRANSFER | 18. SYSTEM/NAVI |
| 9. PLAY / PAUSE | 19. AUX IN |
| 10. REMOTE | 20. MIC |

1. [ANGLE -] / 2. [ANGLE +]

Adjust the view angle of the monitor to choose the best displaying effect.

1- Continual angle adjustment

Hold on pressing the [ANGLE +] / [ANGLE -] buttons to adjust the angle of TFT monitor upward / downward by continual increasing / decreasing.

2- Single step angle adjustment

Press the [ANGLE +] / [ANGLE -] buttons to adjust the angle of TFT monitor upward / downward by singly increasing / decreasing.

3. [EJECT]

When flip down the front panel, press to eject / load a disc.

4. [OPEN] / [CLOSE]

When unit power off, press the [OPEN] button to turn unit on and the monitor will spread out and turn around to the last angle position.

When unit power on, press to open / close the Monitor.

1- Open the TFT Monitor

Press the [OPEN] button, the monitor will spread out and turn around to the last angle position.

2- Close the TFT Monitor

Press the [CLOSE] button, the monitor will turn downward and completely retract in.

5. [POWER/SOURCE]

Press the [POWER/SOURCE] button to turn the unit ON;

Hold on pressing the button to turn the unit OFF.

When the unit in turned ON, press the [POWER/SOURCE] button to toggle between the different modes as following:

RADIO – DVD – USB – IPOD – AV IN – AUX – NAVI – BLUETOOTH – RADIO

NOTE:

The unit could be switched to DVD Mode if disc inside;

The unit could be switched to USB Mode if Mini USB connected;

The unit could be switched to IPOD Mode if iPod connected;

6. [VOL/MENU/SEL]

Rotate the button clockwise / anticlockwise to increase / decrease the volume.

Press the button vertically to return the main menu.

Hold on pressing the button vertically to enter the EQ setting as following:

USER – POP – CLASSIC – ROCK – JAZZ – USER

7. [MUTE]

Press the [MUTE] button to switch off the sound; press it again to resume to the previous volume level.

8. [CALL/TRANSFER]

Press to call a number or to receive a cell phone call.

Hold on pressing to reject or hang up a call.

When talking the phone, touch the icon to transfer the call between the unit and your cell phone.

9. [▶||]

Press to pause playback when playing; press again to continue playing.

10. REMOTE

Infrared Remote Receiver.

11. MINI USB

Connect an USB device to play the songs, pictures, videos in USB.

12. [LEFT] / [UP] / [RIGHT] / [DOWN] / [ENTER] / [BAND]

Under the DVD Setup menu:

Press the [▼] / [▲] buttons to move the cursor upward / downward to select item.

Press the [←] / [→] buttons to move the cursor leftward / rightward to select item.

Press vertically to confirm the operation.

Under RADIO Mode:

Press the [←] / [→] buttons to switch the stored stations.

Hold on pressing the [←] / [→] buttons to fast seeking the next available channel by decreasing / increasing the tuning frequency; seeking will stop by pressing any button.

Press the [▼] / [▲] buttons to decrease / increase the frequency step by step.

Hold on pressing the [▼] / [▲] buttons to fast seeking by decreasing / increasing the tuning frequency; seeking will stop when loose the button.

Press vertically to switch the FM/AM wave band as following:

FM1 - FM2 - FM3 - AM1- AM2 - FM1

13. REL

Press to flip down the front panel.

14. [EJECT]

When flip down the front panel, press to eject / load a disc.

15. [RESET]

Press to reset the unit.

16. [OUT] / 17. [IN]

Press the [OUT] / [IN] buttons to move the monitor forward / backward by singly step.

There are 4 steps to move the monitor forward / backward totally.

18. [SYSTEM/NAVI]

Press to enter / exit the NAVI mode.

Hold on pressing to enter / exit the System Parameter Setup menu.

19. AUX IN

Connect an audio device to this jack to listen to the device through your car speakers.

20. MIC

Microphone.

FRONT PANEL DISPLAY

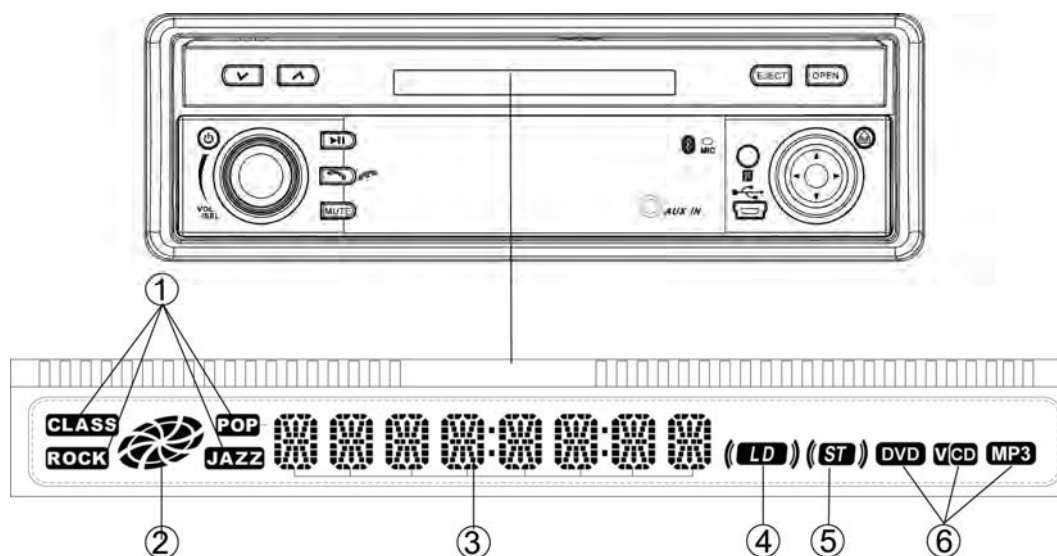

1. EQ Indicator:

It turns on to indicate the POP/CLASSIC/JAZZ/ROCK when corresponding setup. It turns off when custom setup.

2. Disc Icon:

It rotates when playing disc under the DVD Mode.

3. Main Display Area:

Display the information such as working mode, characters, playback time & number of track, radio frequency etc.

4. LOUD Icon:

It displays when the LOUD function on. It disappears when the LOUD function off.

5. ST Icon:

It displays when the STEREO function on. It disappears when the STEREO function off.

6. Disc Type Indicator:

It turns on to indicate DVD, CD, VCD, and MP3 when playing corresponding discs.

REMOTE CONTROL

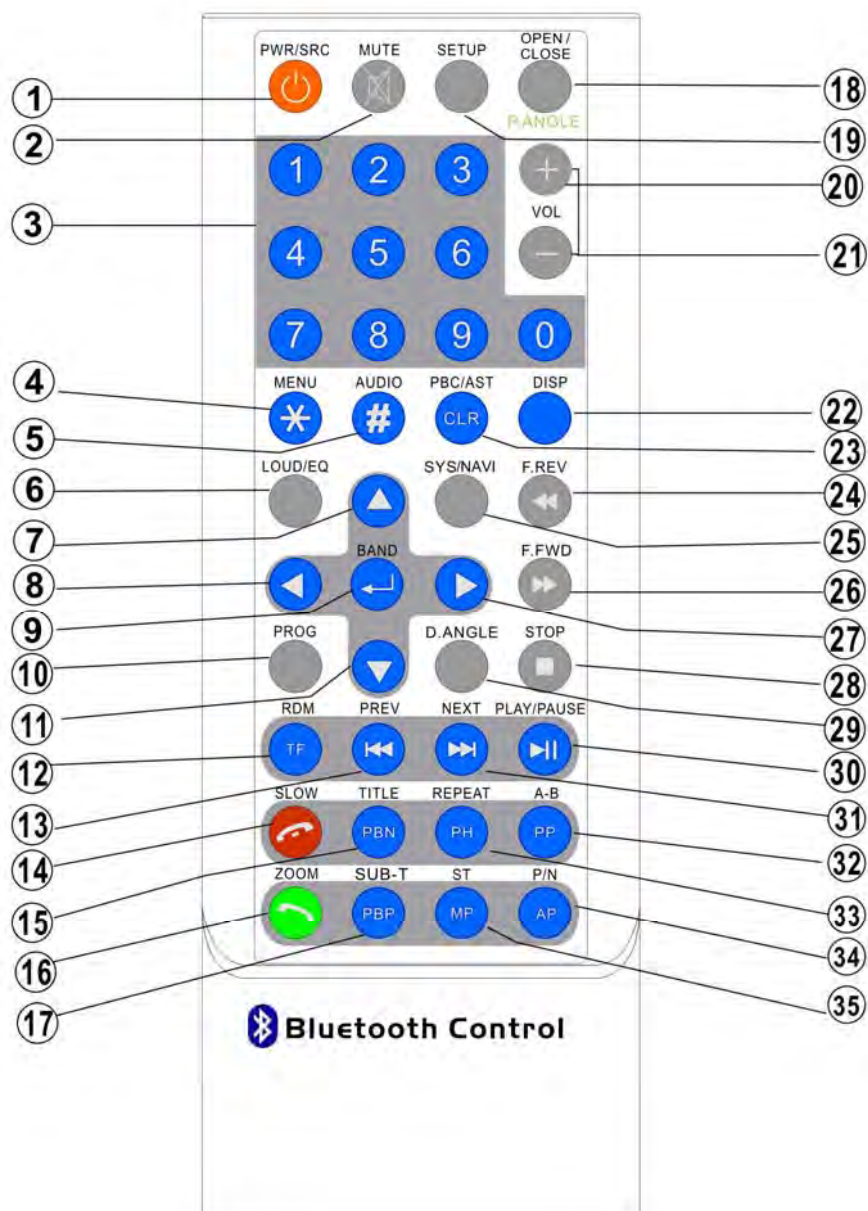

- | | | |
|-----------------------|------------------------|----------------------|
| 1. POWER/SOURCE | 13. PREVIOUS | 25. SYSTEM/NAVI |
| 2. MUTE | 14. SLOW / END CALL | 26. F.FWD |
| 3. NUMBER BUTTONS | 15. TITLE / PBN | 27. RIGHT(Seek up) |
| 4. MENU / * | 16. ZOOM / CALL | 28. STOP |
| 5. AUDIO / # | 17. SUBTITLE / PBP | 29. D.ANGLE |
| 6. LOUD / EQ | 18. OPEN/CLOSE/P.ANGLE | 30. PLAY / PAUSE |
| 7. UP (Tune up) | 19. SETUP | 31. NEXT |
| 8. LEFT (Seek Down) | 20. VOLUME+ | 32. A-B / PHONE PAIR |
| 9. ENTER / BAND | 21. VOLUME- | 33. REPEAT / PHONE |
| 10. PROGRAM | 22. DISPLAY | 34. PAL / NTSC / AP |
| 11. DOWN(Tune Down) | 23. PBC / AST / CLEAR | 35. STEREO / MP |
| 12. RANDOM / TRANSFER | 24. F.REV | |

1. [POWER/SOURCE]

Same functions as key on front panel.

2. [MUTE]

Press the [MUTE] button to switch off the sound; press it again to resume to the previous volume level.

3. [NUMBERS 0~9]

For 1~6, press these buttons to store the current radio station or recall the stored station under the Radio Mode.

For 0~9, press these buttons to select the tracks, and input the number code.

4. [MENU]

Press to return to the boot menu when playing DVD disc.

5. [AUDIO]

Press to select dialogue language when playing DVD disc.

Press to select left audio channel, right audio channel or stereo when playing VCD disc.

6. [LOUD/EQ]

Press to adjust the EQ setting as following:

USER – POP – CLASSIC – ROCK – JAZZ – USER

Hold on pressing to turn the LOUD function on / off.

7. [^] / 8. [<] / 11. [v] / 27. [>] Direction Key

Under the DVD Setup menu:

Press the [v] / [^] buttons to move the cursor upward / downward to select item.

Press the [<] / [>] buttons to move the cursor leftward / rightward to select item.

Under RADIO Mode:

Press the [<] / [>] buttons to switch the stored stations.

Hold on pressing the [<] / [>] buttons to fast seeking the next available channel by decreasing / increasing the tuning frequency; seeking will stop by pressing any button.

Press the [v] / [^] buttons to decrease / increase the frequency step by step.

Hold on pressing the [v] / [^] buttons to fast seeking by decreasing / increasing the tuning frequency; seeking will stop when loose the button.

9. [BAND/ENTER]

In RADIO mode, press the [BAND] button to switch the wave band as following:

FM1 – FM2 - FM3 - AM1- AM2 - FM1

In DVD mode, press the [ENTER] button to confirm the Setup Menu.

10. [PROGRAM]

Press to enter / exit the PROGRAM Function when playing the VCD, CD, MP3 disc.

12. [RANDOM/TRANSFER]

Press to turn RAMDOM function on / off when playing CD / VCD disc (PBC OFF).
When talking the phone, press to transfer the call between the unit and your cell phone.

13. [PREVIOUS]

Press to skip to play the pervious track.

14. [SLOW/END CALL]

Press to activate slow motion playback. (DVD Mode only)
Press to reject or hang up a call.

15. [TITLE/PBN]

Press to enter the title menu when playing DVD disc.
Press to enter the next page of phone number list in phonebook.

16. [ZOOM/CALL]

Press to magnify the picture display when play DVD, VCD disc.
Press to call a number or to receive a cell phone call.

17. [SUB-T/PBP]

Press to select the subtitle language when playing DVD disc.
Press to enter the previous page of phone number list in phonebook.

18. [OPEN/CLOSE/P.ANGLE]

Same functions as key on front panel.

19. [SETUP]

Press to enter the DVD SETUP menu.

20. [VOL+] / 21. [VOL-]

Press to increase / decrease the volume.

22. [DISPLAY]

Press to display current playback information when playing DVD disc.

23. [PBC/AST/CLEAR]

Press to select the PBC function on / off when playing VCD disc.
Hold on pressing to seek radio station automatically under RADIO.
Press to cancel or clear the numbers you have input.

24. [F.REV]

Press to select fast reverse with different speed.

25. [SYSTEM/NAVI]

Same functions as key on front panel.

26. [F.FWD]

Press to select fast forward with different speed.

28. [STOP]

Press to stop the playback.

29. [ANGLE]

Press the [ANGLE] button during playback to select different viewing angles with interactive DVD media.

30. [PLAY/PAUSE]

Press to pause the playback when playing; press again to continue playing.

31. [NEXT]

Press to skip to play the next track.

32. [A-B/PHONE PAIR]

Press to setup A-B repeat playing.

33. [REPEAT/PHONE]

Press to select the chapter / title / disc to repeat playing.

34. [P/N/AUDIO PLAYER]

Press the button to switch the video output (PAL/NTSC) when playing DVD disc.

35. [STEREO/MUSIC PAIR]

Press to turn the stereo on / off under Radio Mode.

REPLACING THE BATTERIES

If the remote control has no function or if the operating range reduced, replace the old battery with new one.

1. Pull out the battery holder. Follow the arrow 1 slide it to the right toward the battery while at the same time pull the battery holder away from the remote control.

2. Place the new battery. Place the new lithium battery with the (+) side up.

3. Push the holder back. Using the finger to push in the holder back until the locking sound is heard.

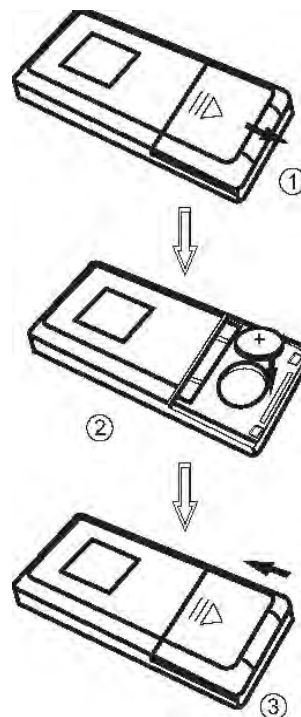

BASIC OPERATIONS

Startup

Press the [POWER/SOURCE] button on the panel or remote control to startup the power, the TFT monitor will spread out automatically and the system return to the working Mode when last turn off.

Turnoff

Hold on pressing the [POWER/SOURCE] button on the panel or remote control to turnoff the power, the TFT monitor will retract automatically.

NOTE:

Close the ACC without turnoff, the unit will turn off automatically; and the TFT monitor will retract within 10 seconds automatically to protect the TFT monitor. Start the ACC again, the unit will startup and return to the last working Mode automatically, but the monitor does not spread out.

Working Mode

When the unit in turned ON, press the [POWER/SOURCE] button to toggle between the different modes as following:

RADIO – DVD – USB – IPOD – AV IN – AUX – NAVI – BLUETOOTH – RADIO

NOTE:

*The unit could be switched to DVD Mode if disc inside;
The unit could be switched to USB Mode if Mini USB connected;
The unit could be switched to IPOD Mode if iPod connected;*

Detachable Front Panel

The front panel is detachable.

Taking out the front panel, the unit will turnoff automatically and the TFT monitor will retract after 5 mins automatically.

NOTE:

*1, don't make any operation within 5 mins.
2, this function is burglarproof for unit security.*

Auto Antenna Control

Connect the auto antenna control wire AUTO_ANT (see Wiring Diagram); the antenna will lift when the unit startup; it will descend when the unit turnoff.

Brake Control

It is necessary to connect the Brake Control wire to the Hand-brake switch of the car. While driving, the TFT monitor will display the alarm picture (see as follows) in order to ensure the safety.

Under the Rear View Mode, the Brake Control function is no effective.

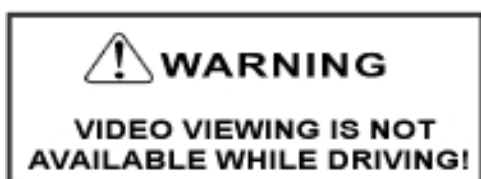

Protection of the TFT Monitor

During the movement of the TFT monitor, if it is halted by force, then the unit will begin self-protection to prevent from any damage on the motorized mechanical structure. Press the [OPEN] button or shut down the ACC and then restart, the TFT monitor will act as the follow list to recover; if not, then please consult with an authorized service center.

Halt	Self-protection	Press the [OPEN] button	Shut down the ACC and restart
While extending	Retraction	Extending	Retraction
While retraction	Stop at the halt place and retract after 3 seconds	Extending	Retraction
While turning upward	Turning downward and retraction	Extending	Turning downward and retract ion
While turning downward	Stop at the halt place	Turning downward and retract ion	Turning downward and retract ion

TOUCH SCREEN OPERATIONS

TOUCH SCREEN CALIBRATE

When "Power Off", press the buttons 1, 2, 3, 4, 5, [BAND] of remote control to enter the CALIBRATE page:

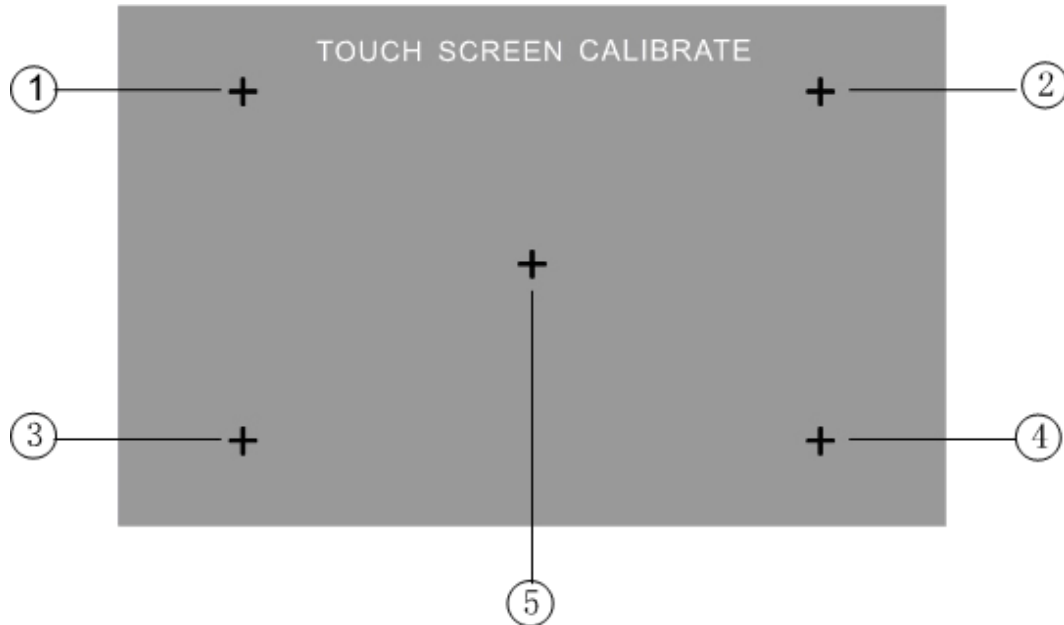

To touch the points from 1 to 5 until the points change to brighter by using a ballpoint pen or pencil.

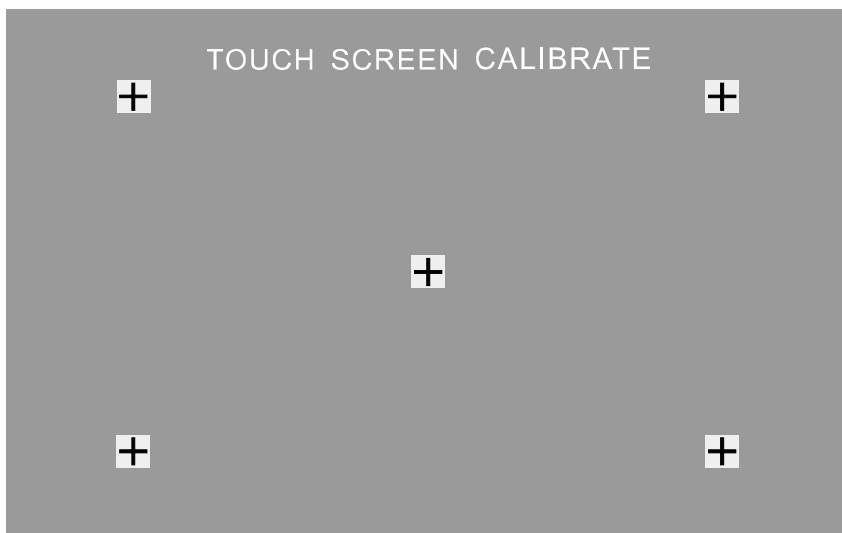

After all 5 points change to brighter, the unit would finish the CALIBRATE and power off again. Then the Touch Screen is restored to their default positions.

MAIN MENU



Touch the icon "MORE" to enter the 2nd page of main menu:



RADIO OPERATIONS

Touch the icon "RADIO" to enter the **1st operation page of RADIO Mode:**

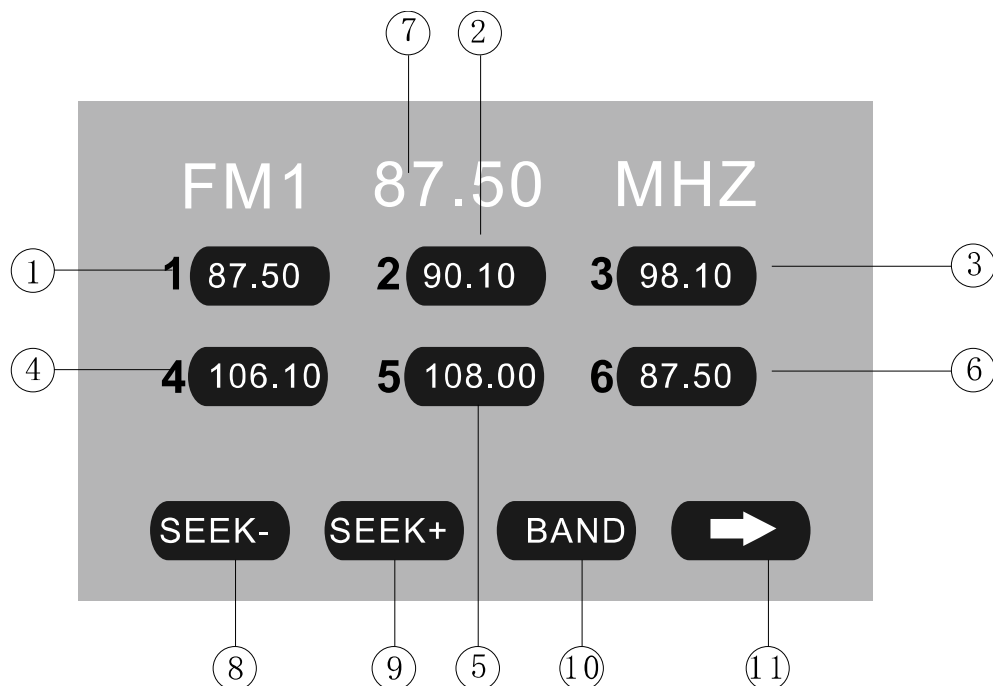

1~6. STORED CHANNEL

Manual Store Radio Station

Hold on touching the icon, you can store current radio frequency to the stored channel. For example, the current frequency is 98.5MHZ, by hold on touching the icon 1, you can store the radio station of 98.5MHZ to the channel 1.

After manual store radio station, the former stored stations will be instead.

In each wave band, the number icons 1 to 6 represent the stored radio stations.

To hold on pressing the number buttons 1~6 of remote control performs same operation.

Recall a Preset Station

Touch the icon 1~6 to recall the corresponding stored station in M1~M6 channels.

To press the number buttons 1~6 of remote control performs same operation.

7. FREQUENCY

8. SEEK - / 9. SEEK +

Touch the icon to seek the next available channel by increasing / decreasing the tuning frequency.

Press any button to stop seeking.

Seeking will stop automatically when seek an available channel then play this station.

The unit will stop on the beginning frequency if no available station after seeking one cycle.

To hold on pressing [>] / [<] buttons of remote control performs same operation.

10. BAND

Touch the icon to switch the FM/AM wave band as following:

FM1 - FM2 - FM3 - AM1- AM2 - FM1

To press the [BAND] button of panel or remote control performs same operation.

11. NEXT PAGE

Touch the icon to enter the 2nd page of RADIO Mode:

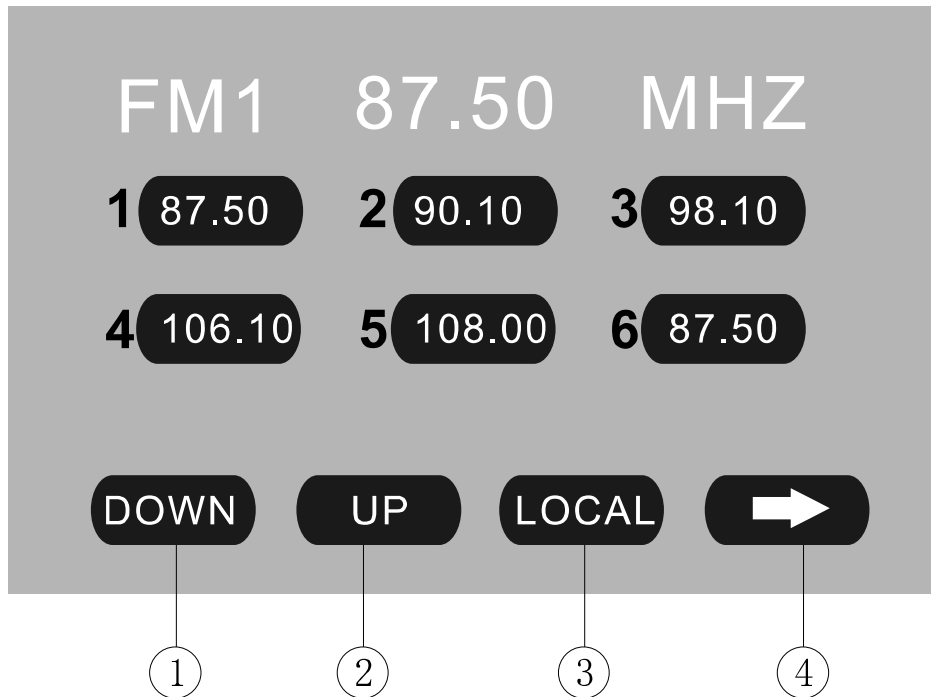

1. DOWN / 2. UP

Touch the icons to adjust the frequency downward / upward by step decreasing / increasing.

Hold on touching the icons has same function with [SEEK-] / [SEEK+].

To press the [∇] / [∧] buttons of remote control performs same operation.

3. LOCAL: ON / OFF

When you are using the local searching function of LOCAL, you can only receive the radio station with strong enough signals and fine state.

4. NEXT PAGE

Touch the icon to enter the 3rd page of RADIO Mode:

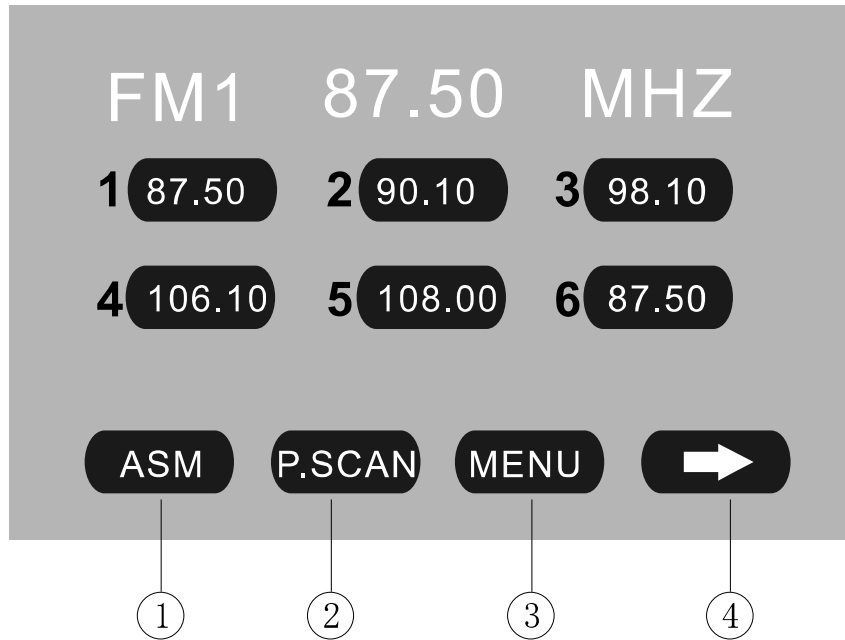

1. ASM

Seeking and store the stations

1. Hold on touching the icon to seek stations with the strongest signal from the lowest frequency point in the entire wave bands; press any button to stop seeking. After seeking, the former stored stations will be instead.
2. Store the received effective radio frequency to the six stored channels M1~M6.
3. The unit will play the stations one by one for few seconds; press any button to stop playing.
4. It is independent for FM & AM frequency. There are 3 wave bands of FM1、FM2、FM3 & 2 wave bands of AM1、AM2, each can store 6 radio stations, totally 30 radio stations.
5. The unit will stop on the beginning frequency if no available station after seeking one cycle.
6. To press the [AST] button of panel or hold on pressing the [PBC/AST] button of remote control performs same operation.

2. P.SCAN

The unit will play the stored stations one by one for few seconds from FM1, FM2, FM3, AM1, AM2; press any button to stop playing.

3. MENU

Touch the icon to return the main menu.

4. NEXT PAGE

Touch the icon to enter the 1st page of RADIO Mode.

DVD OPERATIONS

Touch the icon "DVD" to enter the DVD Mode if disc inside.

The unit will switch to DVD Mode automatically if loading disc.

The unit will switch to RADIO Mode automatically if ejecting disc.

1st operation page of DVD Mode:

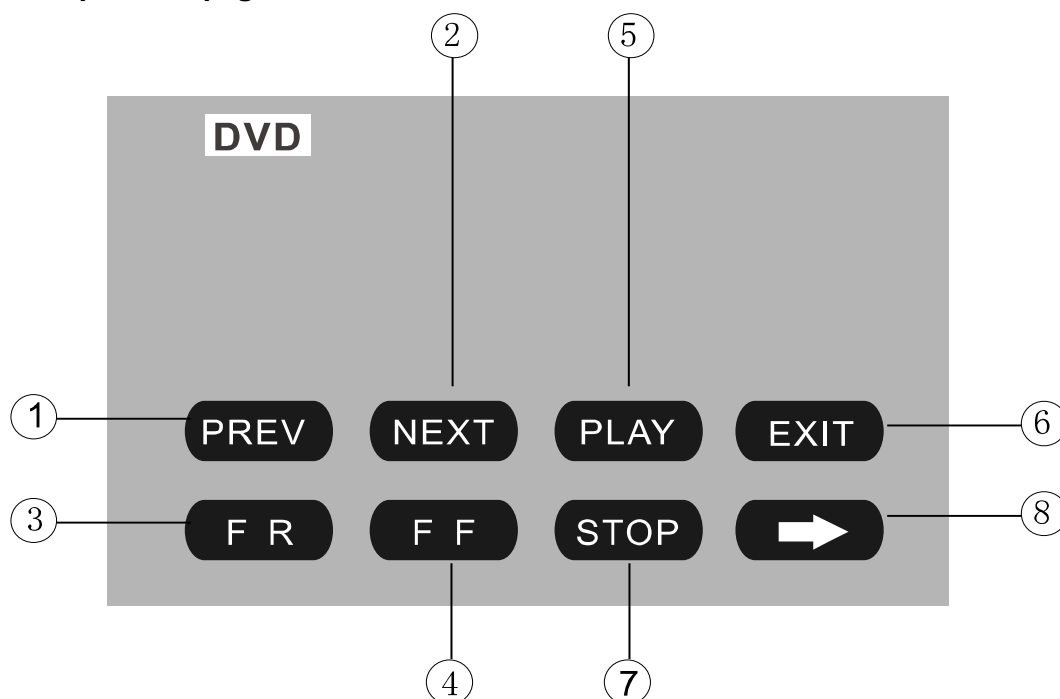

1. PREV / 2. NEXT

Touch the icon to go to the pervious / next chapter, track or song.

To press the [Previous] / [Next] buttons of remote control performs same operation.

3. F.REV / 4. F.FWD

Touch the icon to select fast reverse / forward search. Touch the [PLAY] icon to resume to normal playback.

To press the [F.REV] / [F.FWD] buttons of remote control performs the same operation.

5. PLAY

Touch the icon to play or pause the disc.

To press the [PLAY/PAUSE] button of panel or remote control performs the same operation.

6. EXIT

Touch the icon to exit the TOUCH ICONS display.

7. STOP

During movie playback, touch the icon once; the DVD player memorizes the location where you stopped (touch the [PLAY] icon to resume playing from the memorized location). If you touch the icon twice, the playback will start from the beginning of the disc when you touch the [PLAY] icon.

To press the [STOP] button of remote control performs the same operation.

8. NEXT PAGE

Touch the icon to enter the 2nd page of DVD Mode:

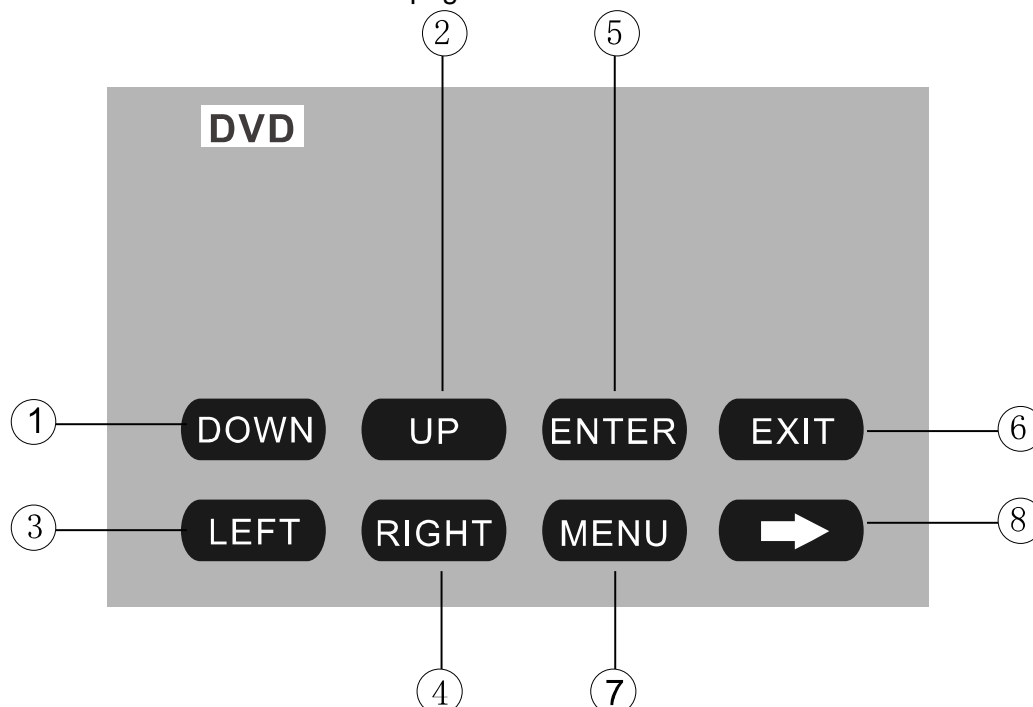

1~4. DOWN / UP / LEFT / RIGHT

Touch the direction icons (UP / DOWN / LEFT / RIGHT) to move the cursor to the selected item.

To press the direction buttons (UP / DOWN / LEFT / RIGHT arrow) of remote control performs same operation.

5. ENTER

Touch the icon to confirm the selection.

To press the [ENTER] button of remote control performs same operation.

6. EXIT

Touch the icon to exit the TOUCH ICONS display.

7. MENU

Touch the icon to return the main menu.

8. NEXT PAGE

Touch the icon to enter the 1st page of DVD Mode.

USB OPERATIONS

Touch the icon “USB” to enter the USB Mode if USB connected.

The unit will switch to USB Mode automatically if connecting USB.

When disconnecting USB, the unit will switch to RADIO Mode automatically if there is no disc in the unit; and the unit will switch to DVD Mode automatically if there is a disc inside.

Under USB Mode, all operations are same as DVD operations.

SD Card Adapter

Connect the SD Card Adapter by USB port, the unit will be switched to DVD Mode automatically, and play the songs, pictures, videos in SD Card.

BLUETOOTH OPERATIONS

Touch the BLUETOOTH icon to enter the Bluetooth mode:

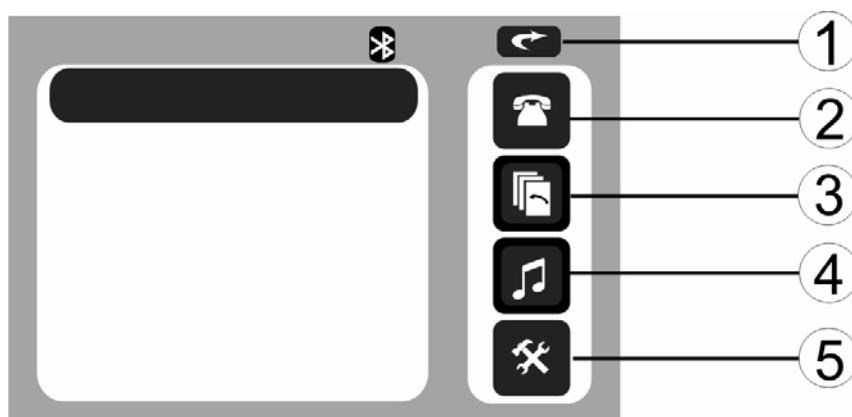

1, RETURN

2, PHONE CALL

3, PHONEBOOK

4, AUDIO

5, SETTINGS

1, RETURN

Touch the icon to return the MAIN MENU.

To press the [DISPLAY] button of remote control performs same operation.

2, PHONE CALL

Touch the icon to enter the phone calling.

3, PHONE BOOK

Touch the icon to enter the phone book lookup.

4, AUDIO

Touch the icon to enter the audio device operation.

5, SETTINGS

Touch the icon to enter the Bluetooth settings.

NOTE:

To press the [BAND] button of remote control to toggle between the different working pages as following:

PHONE CALL – PHONE BOOK – AUDIO – SETTINGS – PHONE CALL

SETTINGS



- 1, INFORMATION DISPLAY 2, AUTO ANSWER 3, PHONEC CONNECT
4, PHONE PAIRING 5, AUDIO PARING 6, PIN CODE

NOTE:

Touch the icon 2~6, when item is changed to blue color, the item is selected. And touch it again and the item is changed to red color, the operation is active.

To press the [V] / [^] buttons of remote control to select the item, and the item would be changed to blue color; To press the [<] / [>] buttons of remote control to activate the operation, and the item would be changed to red color.

1, INFORMATION DISPLAY

2, AUTO ANSWER

Touch the icon to select auto / manual answer when call is coming.

3, PHONEC CONNECT

Touch the icon to select auto / manual phone connect when return back the car.

4, PHONE PAIRING

Touch the icon, then see the below words on information display:

PHONE PAIR WAITING

Then set the phone to pair with unit.

Touch the icon again to cancel the pairing, and see the below words on information display:

PHONE PAIR FAIL

When paring finished, set the phone connect with unit, then you can see the phone name on information display.

To press the [PHONE PAIR] button of remote control under SETTINGS page performs same operation.

5, AUDIO PARING

Touch the icon, then see the below words on information display:

AUDIO PAIR WAITING

Then set the audio device to pair with unit.

Touch the icon again to cancel the pairing, and see the below words on information display:

AUDIO PAIR FAIL

When paring finished, set the audio device connect with unit, then you can see the audio device name on information display.

To press the [MUSIC PAIR] button of remote control under SETTINGS page performs same operation.

6, PIN CODE

You can change the PIN code by remote control. Press the [CLR] key of remote control to clear the PIN code, and input the new 4 digitals number, press the [SETUP] of remote control to save the new code.

NOTE:

The unit can pair with totally 5 different devices including cell phones and audio players.

1, When you want to connect another paired cell phone with unit, to press the [PHONE] button of remote control to disconnect the current connecting cell phone; use the another cell phone to connect with the unit without paring operations.

2, When you disconnected the current connecting cell phone, also you can press the [PHONE] button of remote control to connect the cell phone with the unit again.

3, When you want to connect another paired audio player with unit, to press the [AUDIO PLAYER] button of remote control to disconnect the current connecting audio player; use the another audio player to connect with the unit without paring operations.

4, When you disconnected the current connecting audio player, also you can press the [AUDIO PLAYER] button of remote control to connect the audio player with the unit again.

PHONE CALL

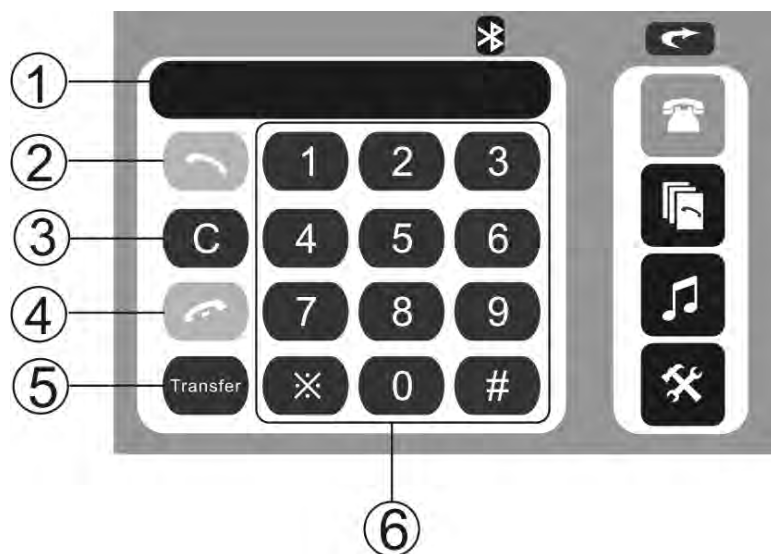

1, INFORMATION DISPLAY

2, CALL

3, CLEAR

4, END CALL

5, TRANSFER

6, NUMBER KEYS

1, INFORMATION DISPLAY

2, CALL

To touch the icon to call a number or to receive a cell phone call.

To press the [CALL] button of remote control performs same operation.

3, CLEAR

To touch the icon to cancel or clear the numbers you have input.

To press the [CLEAR] button of remote control performs same operation.

4, END CALL

To touch the icon to reject or hang up a call.

To press the [END CALL] button of remote control performs same operation.

5, TRANSFER

When talking the phone, touch the icon to transfer the call between the unit and your cell phone.

To press the [TRANSFER] button of remote control performs same operation.

6, NUMBER KEYS

To touch the icon to enter a phone number.

To press the number buttons of remote control performs same operation.

CALLING OUT

When call out, you will see the below information:

CALL OUT.*****

Then when talking, you will see the below information:

TALKING.*****

And end the call, you will see the below information:

END CALL.*****

CALLING IN

When call in, you will see the below image:



Then when talking, you will see the below image:



And when end the call, you will see the below image:



PHONEBOOK



- 1, TRANSFER 2, CALL 3, END CALL
 4, PREVIOUS PAGE 5, NEXT PAGE 6, INFORMATION DISPLAY
 7, MY PHONEBOOK 8, SIM PHONEBOOK 9, DIALED CALL
 10, RECEIVED CALL 11, MISSED CALL

NOTE:

Touch the icon 7~11, when item is changed to blue color, the item is selected. And touch it again and the item is changed to red color, the operation is active.

To press the [V] / [^] buttons of remote control to select the item, and the item would be changed to blue color; To press the [<] / [>] buttons of remote control to activate the operation, and the item would be changed to red color.

1, TRANSFER

When talking the phone, touch the icon to transfer the call between the unit and your cell phone.

To press the [TRANSFER] button of remote control performs same operation.

2, CALL

To touch the icon to call a number or to receive a cell phone call.

To press the [CALL] button of remote control performs same operation.

3, END CALL

To touch the icon to reject or hang up a call.

To press the [END CALL] button of remote control performs same operation.

4~5, PREVIOUS PAGE / NEXT PAGE

There are 5 numbers in each page, touch the icon to see previous / next page.

To press the [PBP] / [PBN] buttons of remote control performs same operation.

6, INFORMATION DISPLAY

7, MY PHONEBOOK

The phone numbers are stored in phone.

8, SIM PHONEBOOK

The phone numbers are stored in SIM card.

9, DIALED CALL

The phone numbers are dialed in phone.

10, RECEIVED CALL

The phone numbers are received in phone.

11, MISSED CALL

The phone numbers are missed in phone.

Touch the icon to enter the phonebook, you will see the below image:

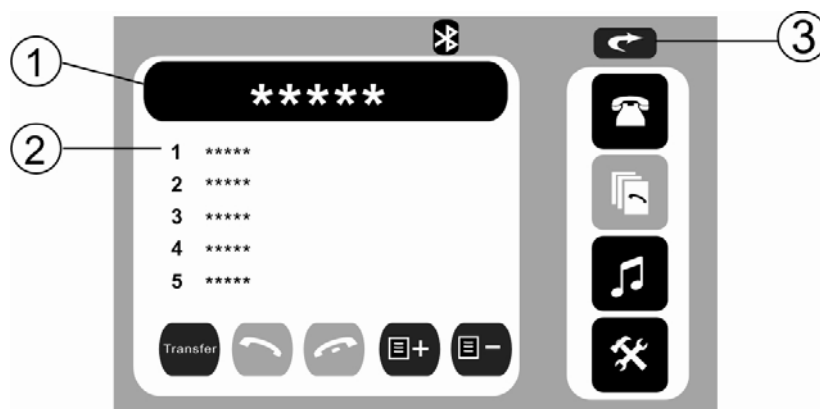

1, INFORMATION DISPLAY

2, CURRENT PHONE NUMBER

3, RETURN

NOTE:

Touch the icon 2, when item is changed to blue color, the item is selected.

To press the [V] / [^] buttons of remote control to select the item and the item would be changed to blue color.

1, INFORMATION DISPLAY

You will see the phone number of the item in blue color.

2, CURRENT PHONE NUMBER

If this number is stored, you will see the name; if not, you will see the phone number.

3, RETURN

Touch the icon to return to PHONE BOOK page.

To press the [DISPLAY] button of remote control performs same operation.

AUDIO

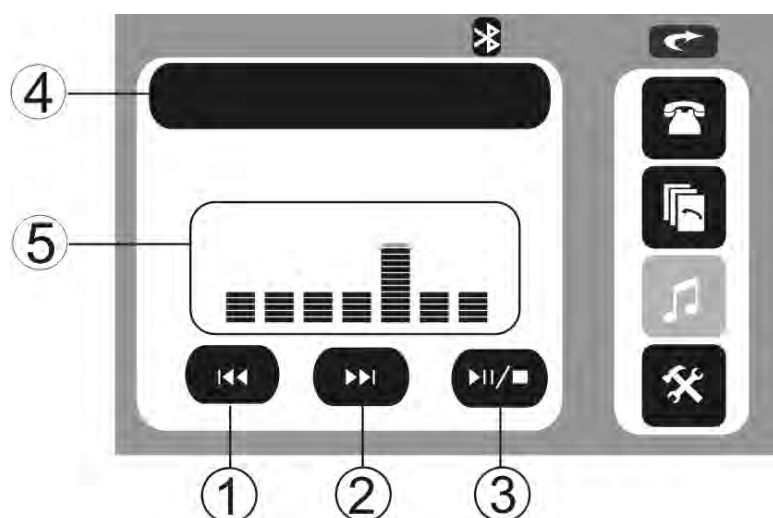

1, PREVIOUS

2, NEXT

3, PLAY / PAUSE

4, INFORMATION DISPLAY

5, EQUALIZER DISPLAY

1, PREVIOUS

Touch the icon to select the previous track.

To press the [PREVIOUS] button of remote control performs same operation.

2, NEXT

Touch the icon to select the next track.

To press the [NEXT] button of remote control performs same operation.

3, PLAY / PAUSE

Touch the icon to pause playback when playing; touch it again to continue playing.

To press the [PLAY / PAUSE] button of remote control performs same operation.

4, INFORMATION DISPLAY

It could be displayed the name of connecting audio device.

IPOD OPERATIONS

Touch the icon "IPOD" to enter the IPOD Mode if iPod connected.

The unit will switch to IPOD Mode automatically if connecting iPod.

The unit will switch to RADIO Mode automatically if disconnecting iPod.

NOTE:

It is available for iPod operations with an additional iPod cable which is optional accessory.

Music Operation

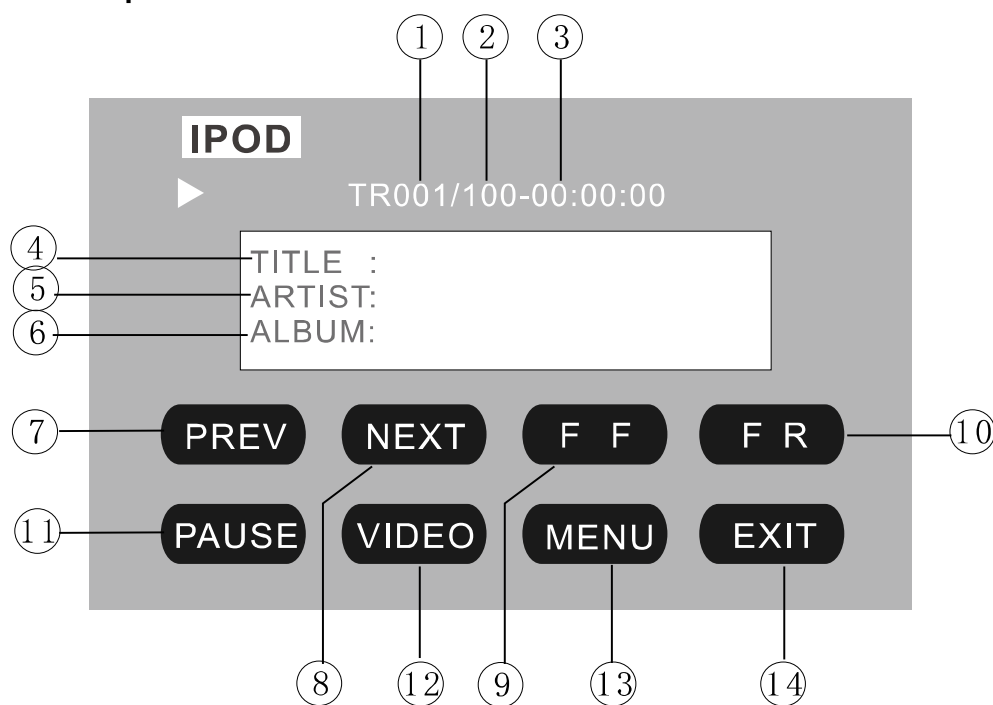

1. The Number of Playing Song

2. The Total Songs in Play List

3. The Playing Time

4. The Name of Playing Song

5. The Name of Artist

6. The Name of Album

7. PREV / 8. NEXT

Touch the icon to go to the pervious / next chapter, track or song.

To press the [PREVIOUS] / [NEXT] buttons of remote control performs same operation.

9. F.REV / 10. F.FWD

Hold on touching the icon to select fast reverse / forward search. Touch the [PLAY] to resume to normal playback.

To press the [F.REV] / [F.FWD] buttons of remote control performs the same operation.

11. PLAY / PAUSE

Touch the icon to play or pause the disc.

To press the [PLAY/PAUSE] button of panel or remote control performs the same operation.

12. VIDEO

Touch the icon to switch to the VIDEO operation.

13. MENU

Touch the icon to return the main menu.

14. EXIT

Touch the icon to exit the TOUCH ICONS display.

Video Operation

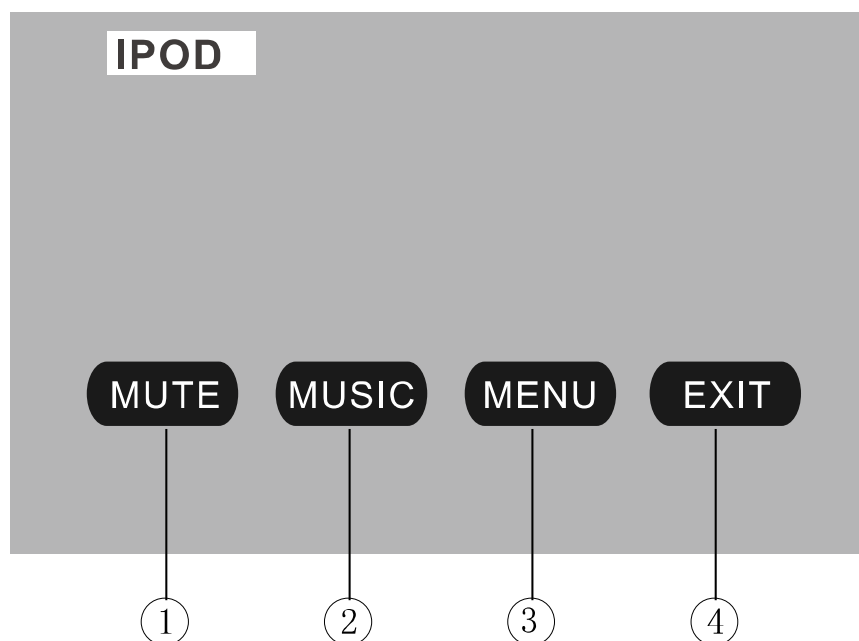

1. MUTE

Touch the icon to switch off the sound; touch it again to resume to the previous volume level.

2. MUSIC

Touch the icon to switch to the MUSIC operation.

3. MENU

Touch the icon to return the main menu.

4. EXIT

Touch the icon to exit the TOUCH ICONS display.

AV IN OPERATIONS

Touch the icon “AV IN” to enter the AV IN Mode:

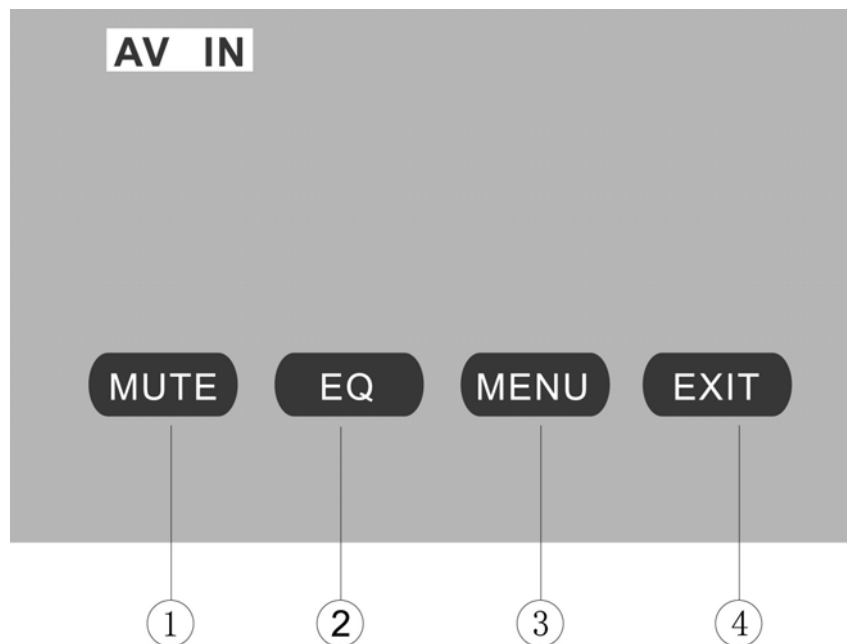

1. MUTE

Touch the icon to switch off the sound; touch it again to resume to the previous volume level.

2. EQ

The user can set to adjust the audio output to your preference:

USER – POP – CLASSIC – ROCK – JAZZ – USER

3. MENU

Touch the icon to return the main menu.

4. EXIT

Touch the icon to exit the TOUCH ICONS display.

NOTE:

It is available to switch to AUX mode under AV IN mode only. Connect an external audio device to AUX IN jack to listen to the device through your car speakers.

AUX OPERATIONS

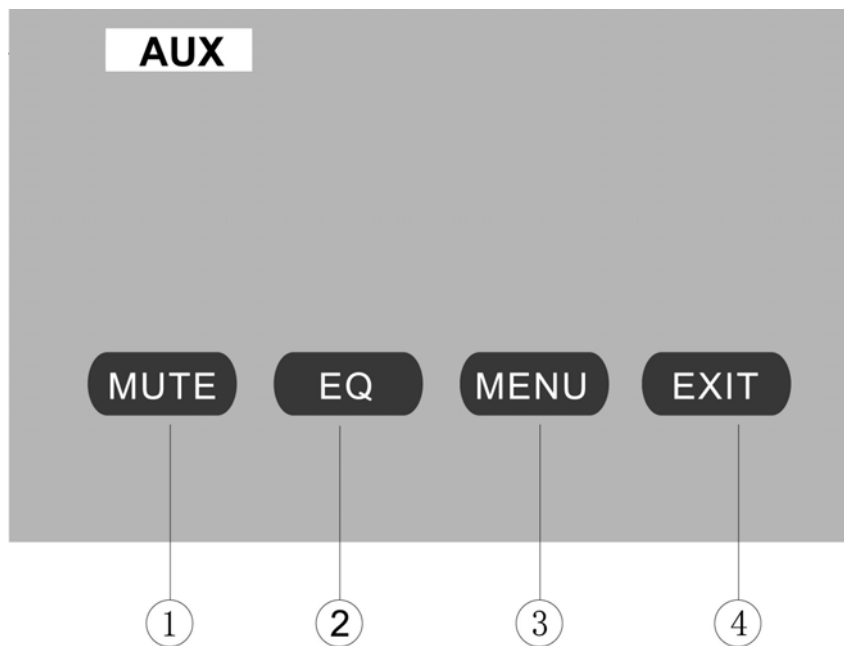

1. MUTE

Touch the icon to switch off the sound; touch it again to resume to the previous volume level.

2. EQ

The user can set to adjust the audio output to your preference:
USER – POP – CLASSIC – ROCK – JAZZ – USER

3. MENU

Touch the icon to return the main menu.

4. EXIT

Touch the icon to exit the TOUCH ICONS display.

NOTE:

There are 2 RCA Audio Inputs & 1 RCA Video Input for unit.

NAVI OPERATIONS

Touch Screen Calibrate

When 1st time to enter NAVI mode, you will see the CALIBRATE screen. Please touch the points from 1 to 5 by using a ballpoint pen or pencil.

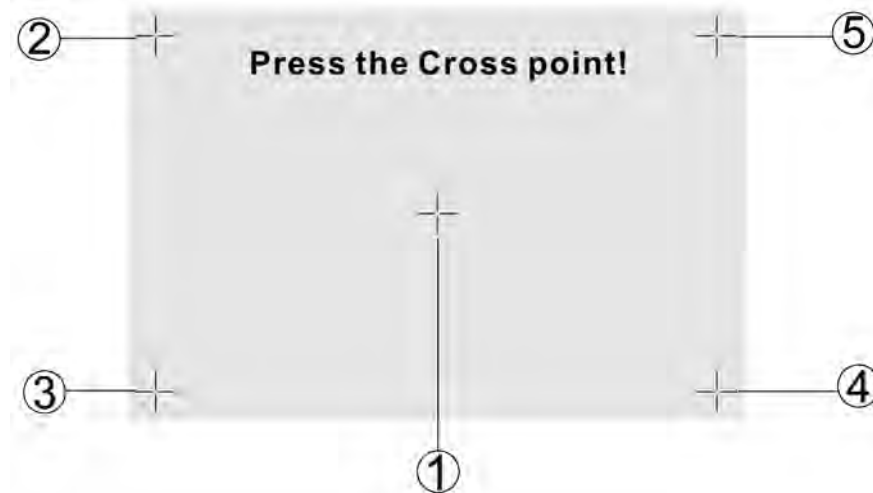

To verify the calibration, please touch the points from 1 to 5 again.



Then the following screen is displayed:

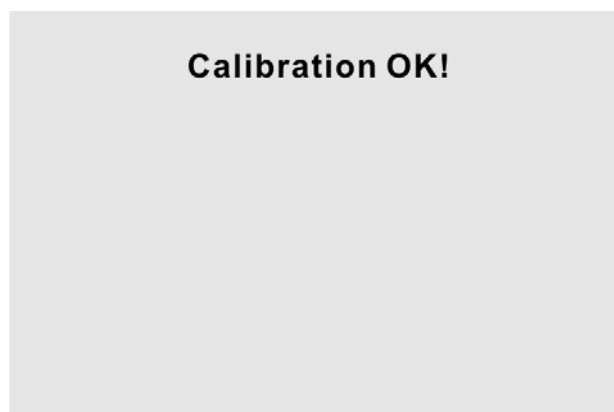

The Touch Screen is restored to their default positions. Touch anywhere of panel to finish the calibration and go to the following screen:



Read information and touch "I agree" button at the bottom of the screen, then enter the NAVI mode.

NOTE:

If change the NAVIBOX to connect another unit, please take out the SD card from the NAVIBOX and connect with computer, the following screen is displayed on computer:

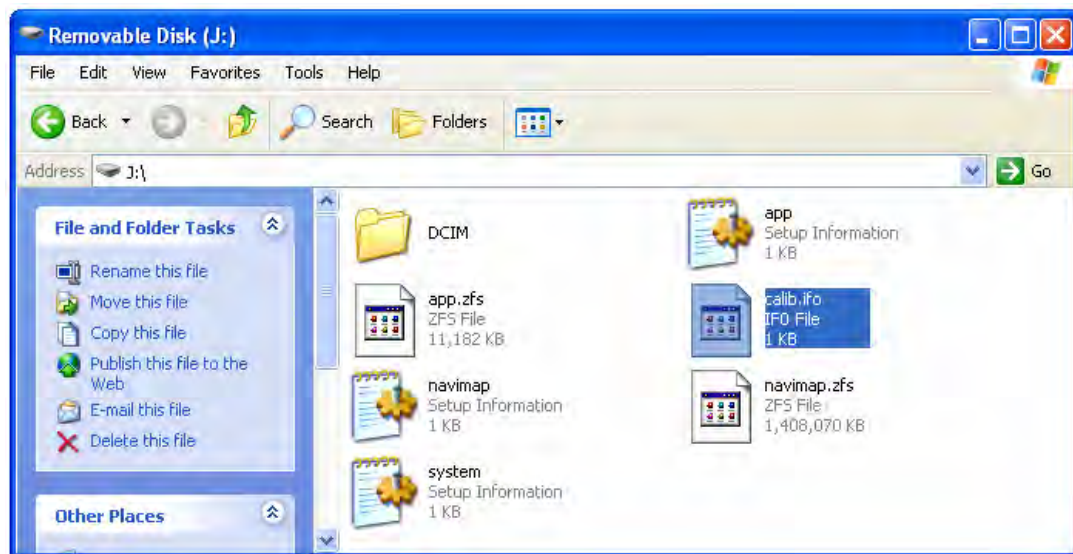

Delete the file "calib.ifo" only. Insert the SD card into NAVIBOX again, and connect the NAVIBOX with another unit.

Go to NAVI mode

Touch the icon “NAVI” to enter the NAVI Mode if NAVIbox connected:



Following screen will be displayed:



Read information and touch “I agree” button at the bottom of the screen.

Enter the NAVI mode by main menu, the NAVI operations are effective only, all other processes are disable such as Radio, CD etc.

NOTE:

Under NAVI mode, please view all operations by Navigation Device NAVIBOX-1 User's manual.

Quick Access Key [NAVI]

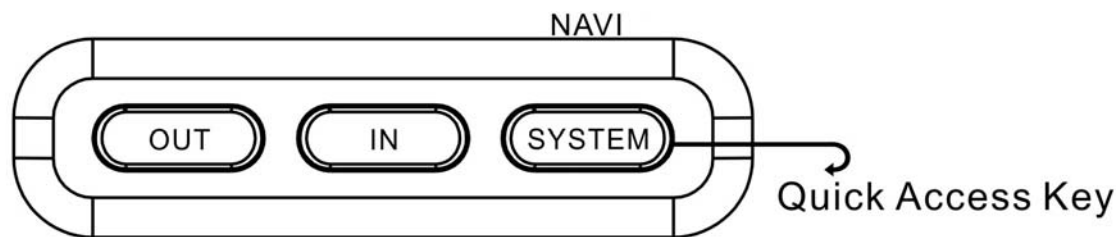

Under any working mode, press the [NAVI] button to switch to NAVI mode; press the NAVI button again to return the previous working mode.

For example, under Radio mode, press the [NAVI] button to switch to NAVI mode; press the button again to quit the NAVI mode and return back the Radio mode.

Enter the NAVI mode by Quick Access Key, the previous working mode is still working on background.

For example, under Radio mode, press the [NAVI] button to switch to NAVI mode, and you can still listen to the radio stations. But when voice of Navigation comes, the radio will be interrupted until voice of Navigation ends.

No NAVIBOX Connection

Touch the "NAVI" icon to enter the following screen if the NAVIBOX not connected:

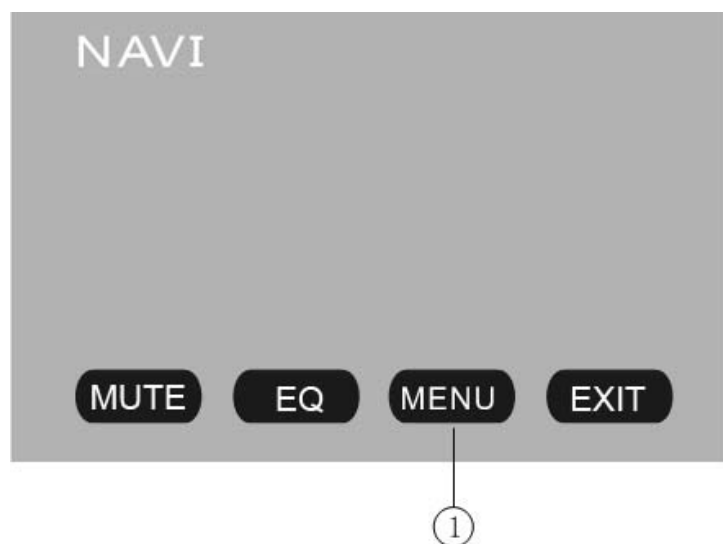

1. MENU

Touch the icon to return the main menu.

SYSTEM SETUP

Touch the icon “SETUP” or press the [SYSTEM] button of panel to enter the SETUP of system parameters:

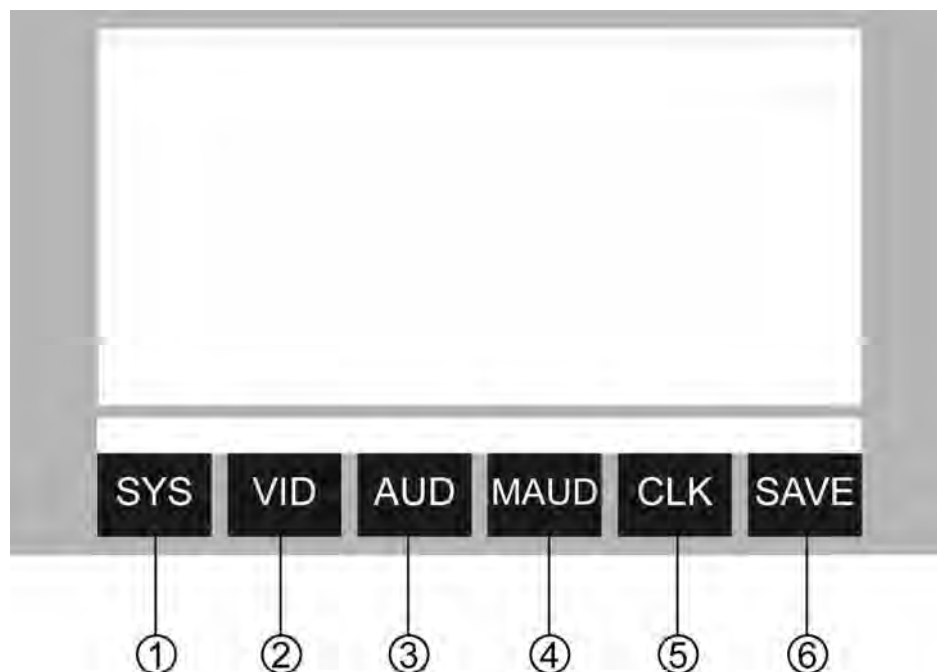

1. SYSTEM SETUP

2. VIDEO SETUP

3. AUDIO SETUP

4. MORE AUDIO SETUP

5. CLOCK SETUP

Touch the icon 1~5 to select the main menus directly.

6. SAVE SETTINGS

Touch the icon 5 to save all settings and exit SETUP.

SETUP MENU OPERATION

Press the [BAND] button of remote control to switch the main menus as following:

SYSTEM – VIDEO – AUDIO – MORE AUDIO – CLOCK – SYSTEM

Press the [v] / [^] buttons of remote control to select the item you want to change.

Press the [<] / [>] buttons of remote control to change the value of item.

Holding on pressing the [SYSTEM] button of panel to exit SETUP of system parameters.

SYSTEM SETUP

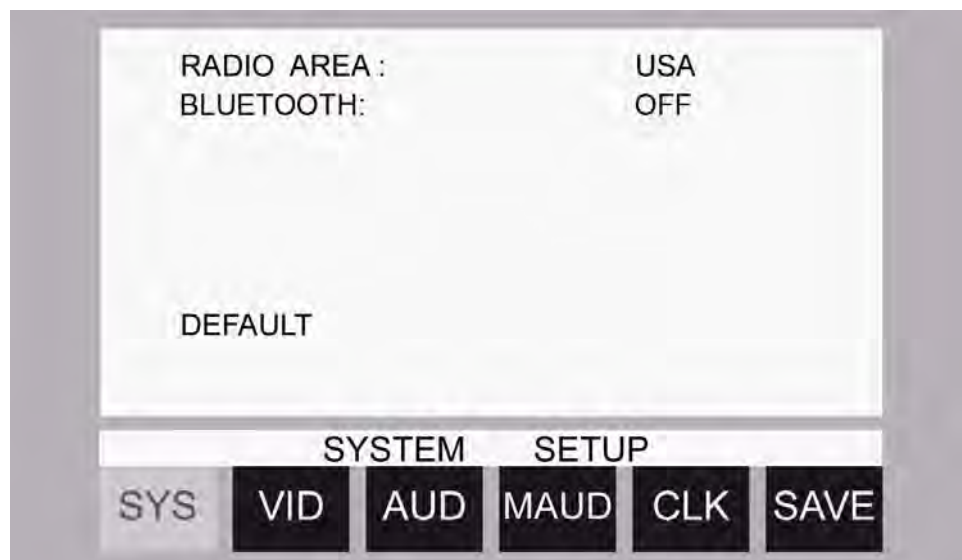

RADIO AREA: USA – JAPAN – OIRT – EUROPE – ASIA – USA

BLUETOOTH: ON/OFF

DEFAULT: The unit will restore all default settings of Sound Parameter, Picture Parameter & Tuner Parameter.

VIDEO SETUP



BRIGHTNESS: 0 ~ 64

CONTRAST: 0 ~ 64

COLOR: 0 ~ 64

HUE: 0 ~ 64

VIDEO TYPE: NTSC – PAL – AUTO – NTSC

NOTE:

It is available to setup of HUE under NTSC VIDEO TYPE only.

AUDIO SETUP

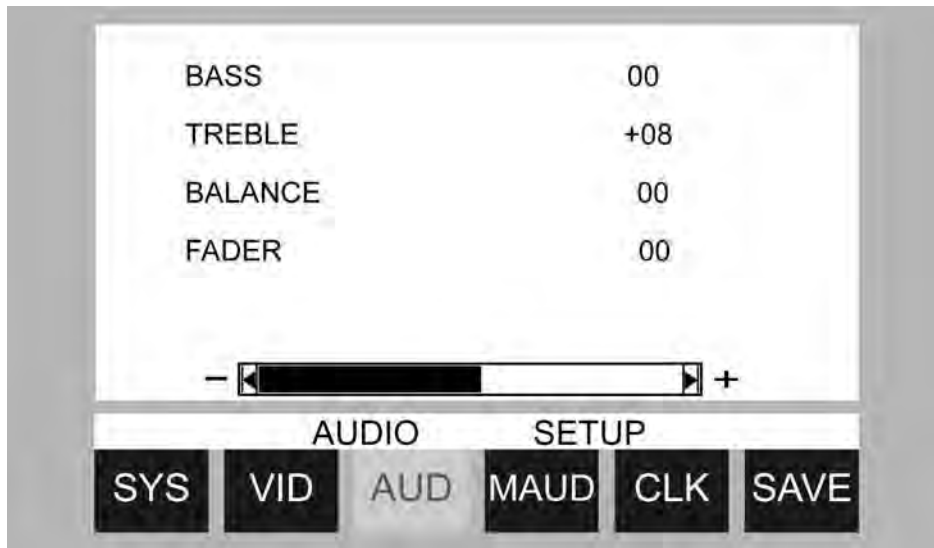

BASS: - 15 ~ + 15
TREBLE: - 15 ~ + 15
BALANCE: L 15 ~ R 15
FADER: F 15 ~ R 15

MORE AUDIO SETUP

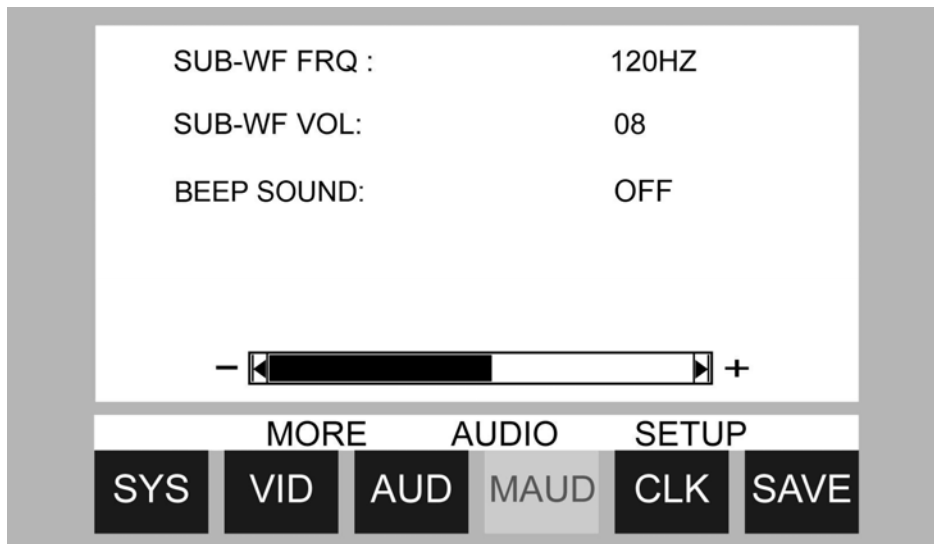

SUB-WF FRQ: 80HZ – 120HZ – 160HZ – OFF – 80HZ
SUB-WF VOL: 0 ~ 15
BEEP SOUND: ON / OFF

CLOCK SETUP

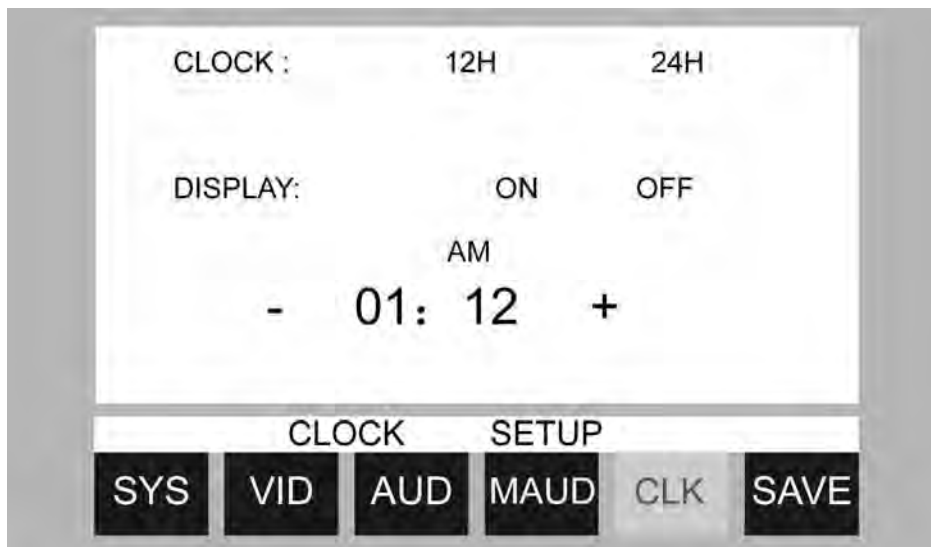

CLOCK: 12H / 24H
DISPLAY: ON / OFF
HOUR: 00 ~ 23
MINUTE: 00 ~ 59

DVD SETUP MUNE

SETUP MENU OPERATION

Press the [SETUP] button of remote control to enter the DVD SETUP Menu.

Press the [<] / [>] buttons to switch the main menus as following:

SYSTEM – LANGUAGE – AUDIO – VIDEO – SPEAKER – DIGITAL

Press the [^] / [v] buttons to enter the submenus from main menus.

Press the [^] button on the top submenu or press the [v] button on the bottom of submenu to exit the submenus to main menus.

Press the [^] / [v] buttons to select the submenus as your need.

Press the [>] or [ENTER] buttons to enter the items of submenus.

Press the [<] button to exit the items of submenus.

Press the [v] / [^] buttons to select the item you want to change.

Press the [ENTER] button to confirm the item you have selected and exit to the submenus.

Press the [SETUP] button of remote control or press the [ENTER] button on the submenu EXIT SETUP to exit the DVD SETUP Menu and save all settings.

NOTE:

Effective only DVD, USB Mode.

SYSTEM MENU

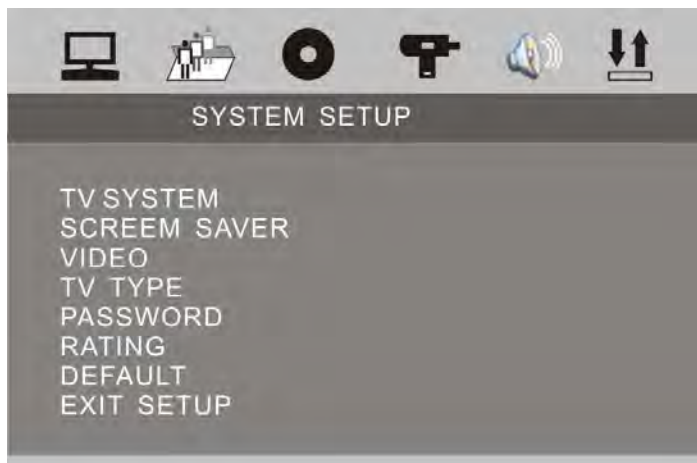

TV SYSTEM

Following options are available for the TV Display:
NTSC

SCREEN SAVER

Select ON or OFF.

VIDEO

Following options are available for the TV Display:

INTERLACE-YUV TV-RGB P-SCAN YPBPR S-VIDEO

TV TYPE

Following options are available for the TV Display:

4 : 3 PS 4 : 3 LB 16 : 9

PASSWORD

Setup the password for Parental Ratings change. The default password is 0000.

RATING

Following options are available for the Parental Ratings:

1 KID SAFE 2 G 3 PG 4 PG 13
5 PG - R 6 R 7 NC - 17 8 ADULT

The Parental Ratings could be changed after the correct password input.

DEFAULT

The unit will restore all default settings by selecting this option.

LANGUAGE SETUP



OSD LANGUAGE

Following options are available for the OSD LANGUAGE:

ENGLISH	GERMAN	SPANISH	FRENCH	PORTUGUESE
ITALIAN	RUSSIAN	DUTCH	SWEDISH	KOREAN
DANISH	NORWEGIAN	POLISH	HUNGARIAN	

AUDIO LANGUAGE

Following options are available for the AUDIO LANGUAGE:

ENGLISH	GERMAN	SPANISH	FRENCH	PORTUGUESE
ITALIAN	RUSSIAN	DUTCH	SWEDISH	KOREAN
DANISH	NORWEGIAN	POLISH	HUNGARIAN	

SUBTITLE LANGUAGE

Following options are available for the SUBTITLE LANGUAGE:

ENGLISH	GERMAN	SPANISH	FRENCH	PORTUGUESE
ITALIAN	RUSSIAN	DUTCH	SWEDISH	KOREAN
DANISH	NORWEGIAN	POLISH	HUNGARIAN	

MENU LANGUAGE

Following options are available for the MENU LANGUAGE:

ENGLISH	GERMAN	SPANISH	FRENCH	PORTUGUESE
ITALIAN	RUSSIAN	DUTCH	SWEDISH	KOREAN
DANISH	NORWEGIAN	POLISH	HUNGARIAN	

DIVX LANGUAGE

Following options are available for the DIVX LANGUAGE:

CENTRAL	EU
WESTERN	EU
KOREAN	

AUDIO SETUP



AUDIO OUT

Following options are available for the AUDIO OUT:

SPDIF / OFF SPDIF / RAW SPDIF / PCM

KEY

Following options are available for the KEY:

b -4 -2 0 +2 +4 #

VIDEO SETUP

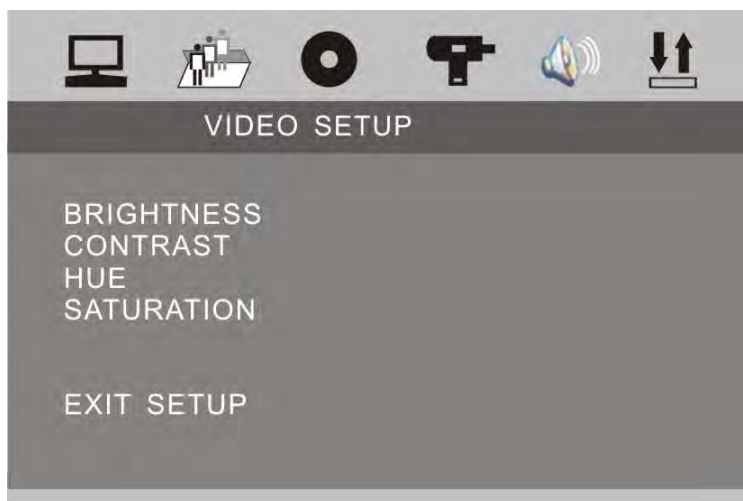

BRIGHTNESS

Following options are available for the BRIGHTNESS:

0 2 4 6 8 10 12

CONTRAST

Following options are available for the CONTRAST:

0 2 4 6 8 10 12

HUE

Following options are available for the HUE:

-6 -4 -2 0 +2 +4 +6

SATURATION

Following options are available for the SATURATION:

0 2 4 6 8 10 12

SPEAKER SETUP



DOWNMIX

Following options are available for the DOWNMIX:

LT / RT Stereo VSS

BASS MODE

Following options are available for the BASS MODE:

ALL LG SPK ALL SM SPK MIXED SPK

DIGITAL SETUP

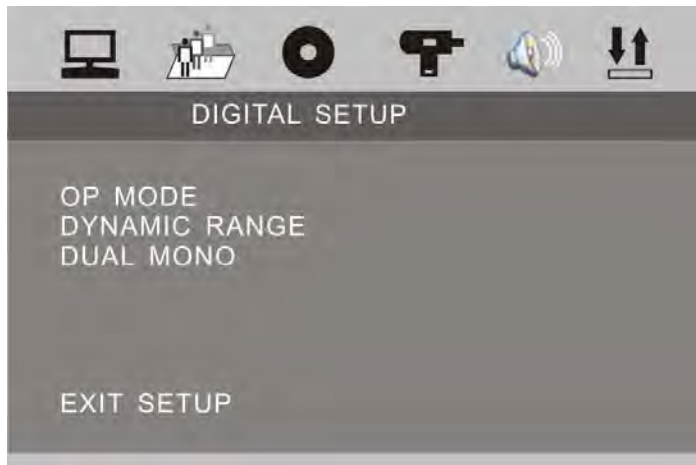

OP MODE

Following options are available for the OP MODE:

LINE OUT RF REMOD

DYNAMIC RANGE

Following options are available for the DYNAMIC RANGE:

FULL 6 / 8 4 / 8 2 / 8 OFF

DUAL MONO

Following options are available for the DUAL MONO:

STEREO MONO L MONO R MIX MONO

TROUBLE SHOOTING

If any of problem persists after checking the below list, Please consult your nearest service dealer.

Never attempt to disassemble and repair unit personally.

Problem	Cause	Corrective Action
GENERAL		
Unit will not power on	ACC Fuse blown Car battery fuse blown illegal operation	Install new fuse with correct rating Install new fuse with correct rating Press the RESET button located in the bottom right corner of the front panel
Remote control does not	Battery depleted Battery installed incorrectly	Replace battery with new one Remove battery and install correctly
No/low audio output	Improper audio output connection Volume set too low Speakers damaged Heavily biased volume balance Speakers wiring is in contact with metal Part or car	Check wiring and correct Increase volume level Review wiring diagram and check MUTE connection Replace speakers Adjust the channel balance to the center position Insulate all speaker wiring connections
Poor sound quality or distortion	Pirate disc is in use Speaker power rating not compatible with unit Speaker is shorted	Use original copy Connect proper speakers Check speaker contact
Unit resets itself when engine is off	Incorrect connection between ACC and Positive battery wire	Check wiring and correct
TUNER		
Weak station searching	Auto antenna is not fully extended Auto antenna not properly connected LOCAL function is activated	Connect the auto antenna control cable properly Connect the auto antenna control cable properly Turn LOCAL function off

Problem	Cause	Corrective Action
TFT MONITOR		
Monitor does not open automatically	TFT Auto Open is turned of	Turn TFT Auto open on
No image	Incorrect connection to parking brake wire PARKING is activated and parking brake is not engaged	Check wiring and correct Stop vehicle in safe place and apply parking brake
Flashing image or interference appears on screen	DVD is not compatible with current TV system settings Image blurred, distorted, or dark	Change setup to accommodate disc
Prolonged image or improper height/width ratio display	Improper video signal connections Improper aspect ratio setup	Check wiring and correct Use correct aspect ratio setting
Monitor stops at incorrect position	Moving path is blocked	Press OPEN key to restart monitor movement
VCD		
Cannot insert disc	Disc already inside unit	Eject current disc and insert new one
Disc does not play back	Disc is warped or scratched Disc is dirty or wet Incompatible disc is used Disc rating exceeds Parental Lock rating limit Disc region code is not compatible with unit Disc is inserted upside down	Use disc in good condition Clean disc with soft cloth Use compatible disc Change parental Lock settings to lower restriction Use compatible disc Change Parental Lock settings to lower restriction Use disc with proper region cod Insert disc with label side up
Image blurred , distorted, or dark	Disc is illegally copied	Use original disc
PBC cannot be used during VCD playback	PBC is not available on the disc	
No repeat or searching while playing VCD	PBC is on	Turn PBC off

Problem	Cause	Corrective Action
MP3		
Interruption occurred during playback	Disc is dirty or scratched	Clean disc or replace
Cannot read disc	File is damaged/bad recording	Recreate disc with good files
Incorrect playback message displayed	Message is longer than LCD can display	

Error Messages

Message Displayed	Cause	Corrective Action
Loading	Disc is being read	
No disc	Disc is dirty	Clean disc with soft cloth
	Disc is upside down	Insert disc with label side up
	Disc not present in loading compartment	Insert disc
Bad Disc	Disc is dirty	Clean disc with soft cloth
	Disc is upside down	Insert disc with label side up
Unknown disc	Disc format is not compatible with this unit	
Region Error	DVD is not compatible with region code of unit	
Error	illegal mechanism operation	Press EJECT key for 5 seconds to reset loading mechanism

SPECIFICATIONS

GENERAL

Supply Voltage	: 14.4 V DC (10.8-16 V DC Allowable)
Load Impedance	: 4 Ω
Max Power Output	: 50 W x 4
Bass 100Hz	: \geq 10dB
Treble 10KHz	: \geq 10dB
Dimension (approx)	: 187 x 188 x 60 mm (d/w/h)
Mounting (approx)	: 160 x 178 x 50 mm (d/w/h)

FM TUNER

Frequency Range	: 87.5-107.9 MHz (USA) : 87.5-108.0 MHz (Europe/China)
IF	: 10.7 MHz
Usable Sensitivity	: \leq 15 dB μ V
Stereo Separation	: \geq 27 dB(1KHz)
Frequency Response	: 20-10000 Hz

AM TUNER

Frequency Range	: 530-1710 KHz (USA) : 522-1620 KHz (Europe) : 531-1602 KHz (China)
IF	: 450 KHz
Usable Sensitivity	: \leq 34 dB μ V

DVD PLAYER

Signal System	: PAL/NTSC
Signal-to-noise Ratio	: \geq 80 dB(1KHz)
Distortion	: \leq 0.5%

MONITOR

Resolution	: 1440 (w) x 234 (H) (RGB)
Brightness	: 350 cd/m ²
Contrast	: 300:1

NOTE:

Specifications and design are subject to modification without notice due to improvements in technology.

DISC NOTES

- Disc formats supported by this player



Handling and Cleaning

- Dirty, dusty, scratched or warped discs will cause misoperation.
- Do not place stickers or make scratches on discs.
- Do not warp discs.
- A disc should always be kept in its case when not in use to prevent from damage.
- Do not place discs in the following places:
 1. Direct sunlight.
 2. Dirty, dusty and damp areas.
 3. High temperature places.
 4. On the seats or dashboard.

Disc Cleaning

Use a dry soft cloth to wipe the surface. If the disc is quite dirty, use a soft cloth slightly moist with isopropyl (rubbing) alcohol. Never use solvent such as benzene, thinner or conventional record cleaners which may mar the surface of the disc.

NOTE:

A disc may become somewhat scratched (although not enough to make it unusable), which depends on your handling it in the condition of the usage environment. These scratches are not an indication of any problem with the player.

“Dolby” and the double-D symbol are trademarks of Dolby Laboratories.

Repairing New Discs with Rough Spots

A new disc may have rough edges on its inside and outside edges. If a disc with rough edges is used, the proper setting will not be performed and the player will not play the disc. Therefore, remove the rough edges in advance by using a ballpoint pen or pencil. To remove the rough edges, press the side of the pen or pencil against the inside and outside edges of the disc.

