

**7" Wide Touch Screen**

**In-Dash Fully Motorized TFT Monitor /DVD/AM/FM**

**Built-In TV Tuner**

# Operating manual

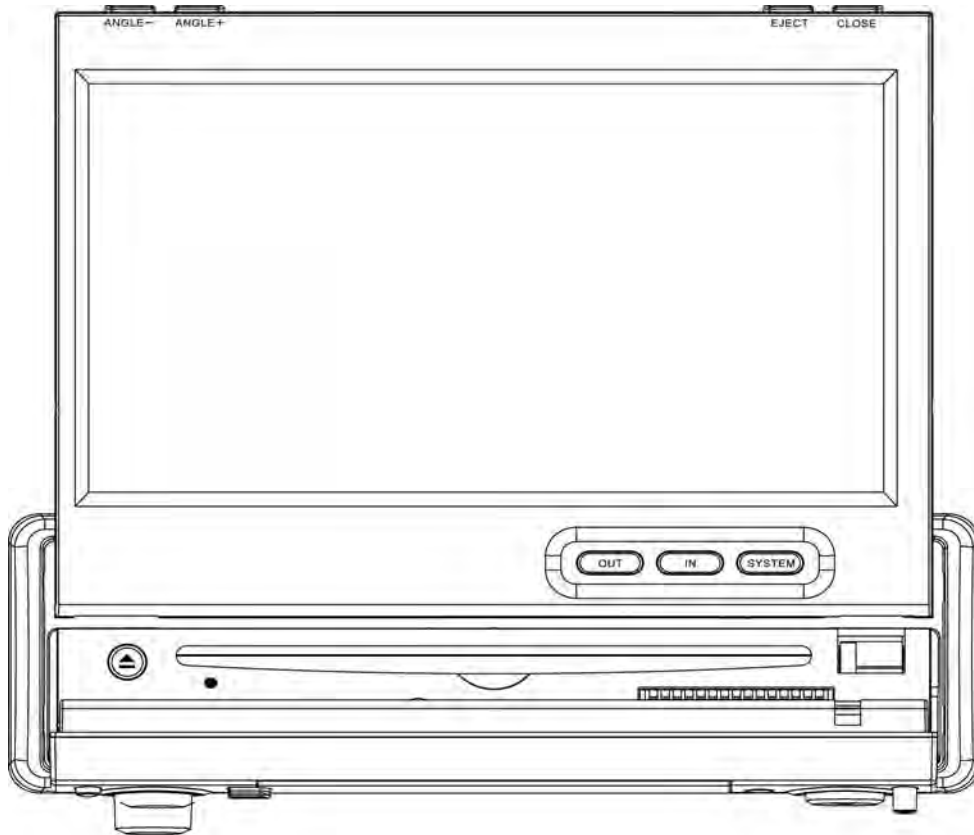

## **SAFETY INFORMATION**

*PLEASE READ COMPLETELY AND BECOME FAMILIAR WITH THE CONTENTS OF THIS MANUAL BEFORE INSTALLATION AND OPERATION OF THIS UNIT, AND KEEP IT CAREFULLY FOR FUTURE REFERENCE.*

This unit is a class 1 laser product. The laser beam may cause hazardous radiation if exposure to laser system directly. Do not attempt to disassemble the unit personally.

This unit has been designed and manufactured to assure personal safety. Improper use can result in electric shock or fire hazard. The safeguards incorporated in this unit protect you if you observe the following procedures for installation, use and servicing. This unit doesn't contain any parts that can be repaired by the user. If the unit requires maintenance, contact an authorized service center.

### **Warnings**

- Do not expose the product to rain, water or excessive moisture. This could cause electrical shorts, fire or other damage.
- This product is designed to operate with a 12 volt DC, negative ground battery system. Use the proper power supply.
- The monitor is operated automatically. Do not push in or pull out the monitor or try to reverse the monitor manually! Do not attempt to adjust the monitor angle upward or downward manually. It will cause damage to the Monitor Mechanism Structure.
- Do not impact the monitor with a hard object. It may cause permanent damage.
- Do ground all equipments and works in order to avoid causing damage to the unit by electrostatic discharges.
- The user who handles this product takes all necessary precautions to avoid ESD (Electro-Static Discharge) failures.
- Do not attempt to install or service your unit by yourself. Installation or servicing of the unit by persons without training and experience in electronic equipment and automotive accessories may be dangerous and could expose you to the risk of electric shock or other hazards.

### **Cautions:**

- ① To reduce the risk of fire or electric shock, and annoying interference, use only the recommended accessories.
- ① While driving, keep the volume level low enough to be aware of road and traffic conditions.
- ① Parking in direct sunlight can produce very high temperatures inside your vehicle. Give the interior a chance to cool down before starting playback.
- ① Do not use any chemical solvent, cleaning agent or corrosive detergent to clean away dirt on the surface of the TFT monitor screen. It may cause irreversible damage.
- ① Small black and shiny dots inside the liquid crystal panel are normal for liquid crystal product.
- ① In extremely cold temperatures, the movement of the picture may be slow and the picture may be dark, but this is not a malfunction. The unit will work normally once reach its operating temperature.
- ① Do not use and store the unit in dusty, high temperature and high humidity environments.
- ① Do not use the unit immediately when you bring it from cold to warm place. Fast growing temperature, may cause moisture condensing which influence the unit for certain time.

### **NOTE:**

- ① **This user's manual only for reference.**
- ① **Modifying rights are reserved.**
- ① **Modifications are subject to change without notice.**

## **FEATURES**

- Fully Motorized Screen Telescopes Out And Up Including Front To Back Angling
- Drop Down Detachable Front Panel For Invisible DVD Insertion Slot
- Electronic Touch Screen Functions Include DVD, Radio, USB, & MP-3/4
- Front Panel Display When The Monitor Is Closed
- Electronic Touch Screen Functions Include OSD Functions
- DVD/DVD-RW/CD/CD-R/CD-RW/MP-3/MP-4/Divx
- Menus Can Be Displayed On Screen Via OSD (Fourteen Languages)
- 30-Second Electronic Anti-shock Mechanism
- Accessory iPod Input Connection (Cable Not Included)
- USB Mini Input For Mp-3 Music, Divx, Xvid & Mp-4 Movies
- IR Repeater For External Remote Eye
- Antenna Trigger Wire
- Amplifier Trigger Wire
- Brake Screen Safety Trigger
- AM/FM With 30 Pre-sets (18/FM - 12AM)
- Auto Store Pre-set Scan
- 4-Channel High Power 50 X 4 Channels (Mosfet Power)
- Dual RCA Outputs (Front & Rear)
- Sub Woofer Selectable Frequency Outputs (80, 120, 160Hz)
- Variable Sub Woofer Volume Control
- 1-Auxiliary Video Input For Back-up Camera
- 1-A/V In For Secondary Source Input
- 1-RCA Video Output
- LO/DX And Stereo Mono Selector Switch
- Electronic (Bass, Treble, Volume, Balance, Fader)
- Pre-set EQ Functions (Rock, Pop, Classic, Jazz, User)
- Digital Clock
- DVD, PAL/NTSC Selectable
- USA/EUROPE Frequency Stepping
- Resolution: 1440 X 234
- Panel Brightness: 350 NIT
- ISO/DIN
- Full Function Remote Control
- Last Position DVD Memory
- Improved Graphic User Interface

## **TABLE OF CONTENTS**

Safety Information.....	1
Features.....	3
Table of Contents.....	4
Accessories.....	5
Unit Installation.....	6
Unit Removal.....	8
Wiring Connection.....	9
Front Panel.....	12
Remote Control.....	17
Basic Operation.....	22
Touch Screen Operations.....	24
Touch Screen Calibrate.....	24
Main Menu.....	25
Radio Operations.....	26
DVD Operations.....	29
USB Operations.....	31
TV Operations.....	32
iPod Operations.....	35
AV IN Operations.....	37
CDC Operations.....	39
System Setup.....	41
DVD Setup Menu.....	45
Troubleshooting.....	51
Specifications.....	54
Disc Notes.....	55

**ACCESSORIES**

1

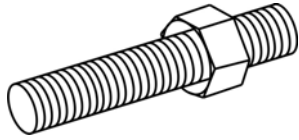

Bolt

2

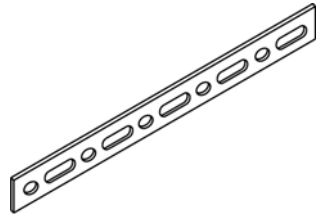

Steel Bar x 1

3



M5X5 Screws x 4

4

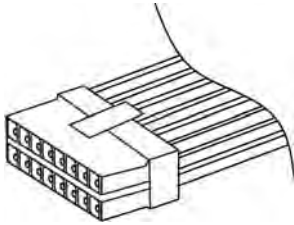

Connector Wire x 1

5

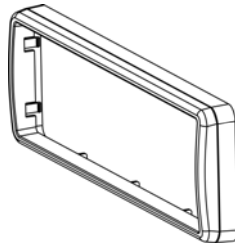

Trim Bezel x 1

6

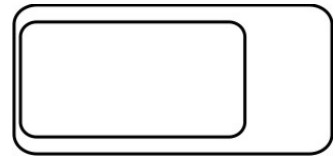

Remote Control x 1

7

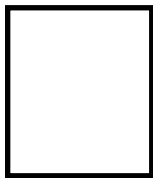

Operational Manual x 1

8

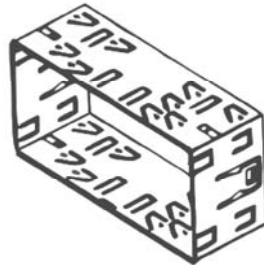

Mounting Sleeve x 1

9



Keys x 2

10

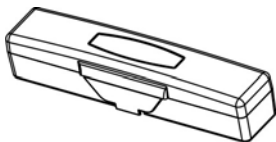

Box x 1

11



Nut M5 x 1

12

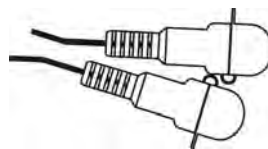

AUX Cable x 1

## **UNIT INSTALLATION**

Please read all of the instructions before beginning the installation. Recommend having your unit installed by a professional installation shop.

### **Tools and Supplies:**

You will need these tools and supplies to install your unit:

- Torx type, flat-head and Philips screwdrivers
- Wire cutters and strippers
- Tools to remove existing radio (screwdriver, socket wrench set or other tools)
- Electrical tape
- Crimping tool
- Volt meter/test light
- Crimp connections
- 16 gauge wire for power connections
- 8 gauge speaker wire

### **Warnings:**

Choose the mounting location where the unit will not interfere with the safe driving conditions.

Install the unit where it does not get in the driver's way and can not injure the passenger if there is a sudden stop, like an emergency stop.

Avoid installing the unit where it would be subject to high temperature, such as from direct sunlight, or from hot air, from the heater, or where it would be subject to dust, dirt or excessive vibration.

### **Cautions:**

Before finally installing the unit, connect the wiring temporarily and make sure it is all connected up properly, the unit and the system work properly.

Use only the parts included with the unit to ensure proper installation. The use of unauthorized parts can cause malfunctions.

Consult with your nearest dealer if installation requires the drilling of holes or other modifications of the vehicle.

If installation angle exceeds 30 degrees from horizontal, the unit might not give its optimum performance.

● Securing the Unit to the Mounting Bracket.

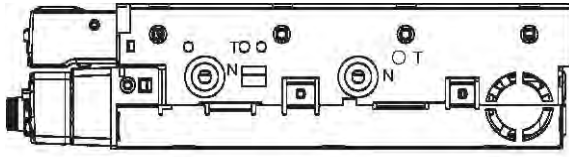

**Installation Method**

1. Install the front panel into the unit.

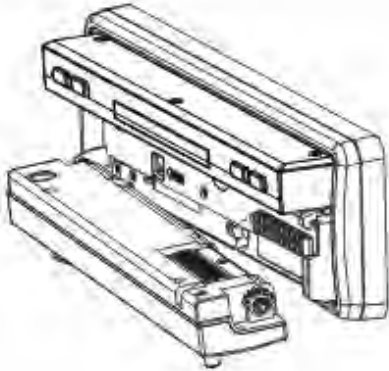

2. Bend the claws outward for tight fit, if necessary. Install the Mounting Box into the dashboard, tighten the unit in place.

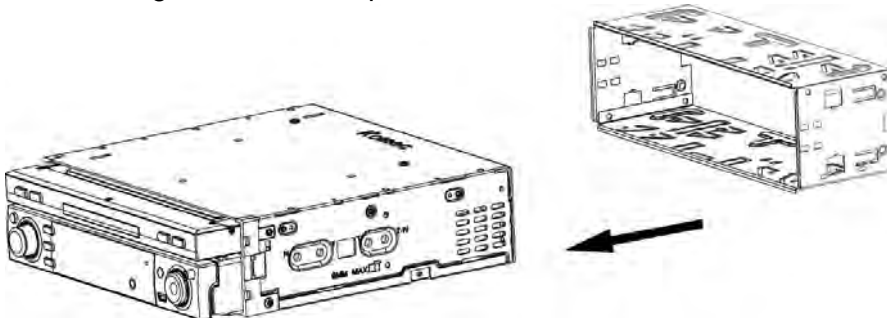

3. Install the Frame to the unit.

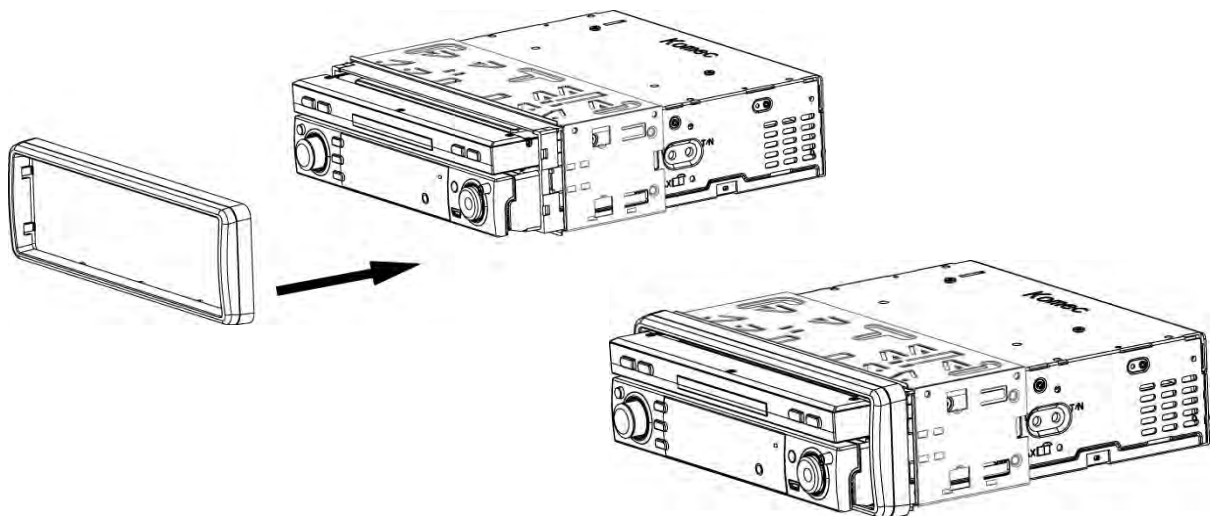

## UNIT REMOVAL

1. Detach the front panel.

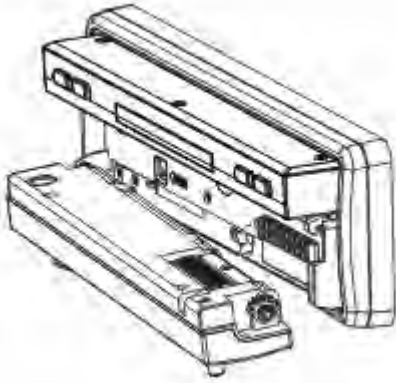

2. Insert the keys that supply to the unit at both sides of the unit (shown as illustrated) until pull the keys to make it possible to remove the unit from the dashboard.

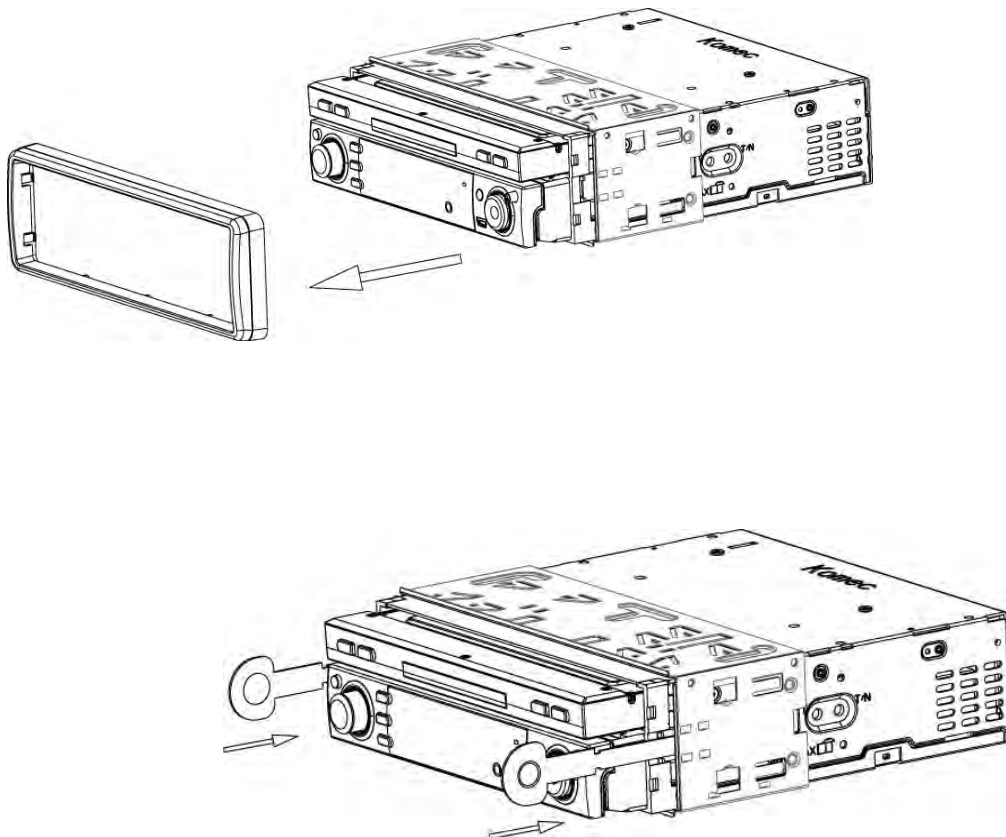

## **WIRING CONNECTION**

### **Cautions:**

- To prevent short circuits, remove the key from the ignition and disconnect the terminal of the battery.
- Make the proper input and output cable connections for each unit.
- Connect the wiring harness cables in the following order: ground wire, battery wire, ignition wire.
- Reconnect the terminal of the battery.
- Do not connect the yellow wire of this product directly to the battery terminal.
- Do remember to connect the red wire of this product to the ACC. of the ignition key switch. Failure to do may result in draining off the battery charge prematurely.
- If the fuse blows, first make sure that the cables have not caused a short circuit, then replace the old fuse with new one with the same rating.
- Do not let unconnected cables or terminals touch the metal on the car or other conductor.
- To prevent short circuits, do not remove the caps from unused terminals or from the ends of the unconnected cables.
- After the monitor unit is installed, check whether the brake lamps, blinkers, wiper, etc. on the vehicle are working properly. If not, please make sure they are properly installed.
- Insulate unconnected wires with vinyl tape or other similar material.

### **Disconnecting the Battery**

To prevent a short circuit, be sure to turn off the ignition and remove the negative (-) battery cable prior to installation.

### **Reconnecting the Battery**

When wiring is complete, reconnect the battery negative terminal.

### **Warning:**

Be sure to use the correct type and amperage Fuse to avoid damaging the unit.

Fuse of the Battery wire in Main Unit: 1 amp;

Fuse of the ACC wire in Main Unit: 1 amp;

## Wiring Diagram

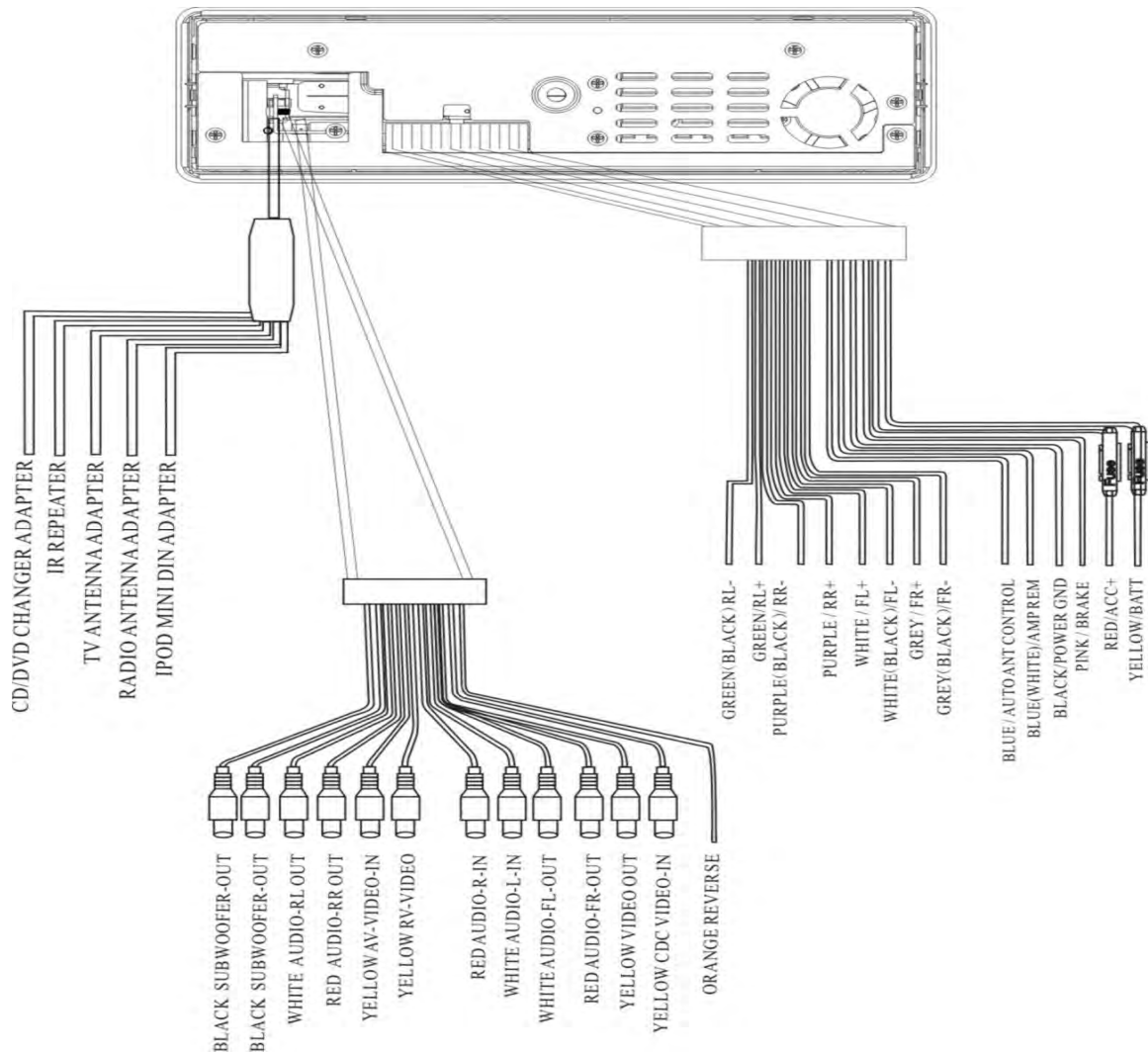

### **NOTE:**

- 1, Plug the external microphone input into the MIC-IN jack for Bluetooth.
- 2, Please separate Battery Units before setting products to prevent from fire and electric shock. Mounting the antenna near to a radio antenna will result in noise. In this case, consult your dealer concerning mounting location.

# Wiring Diagram

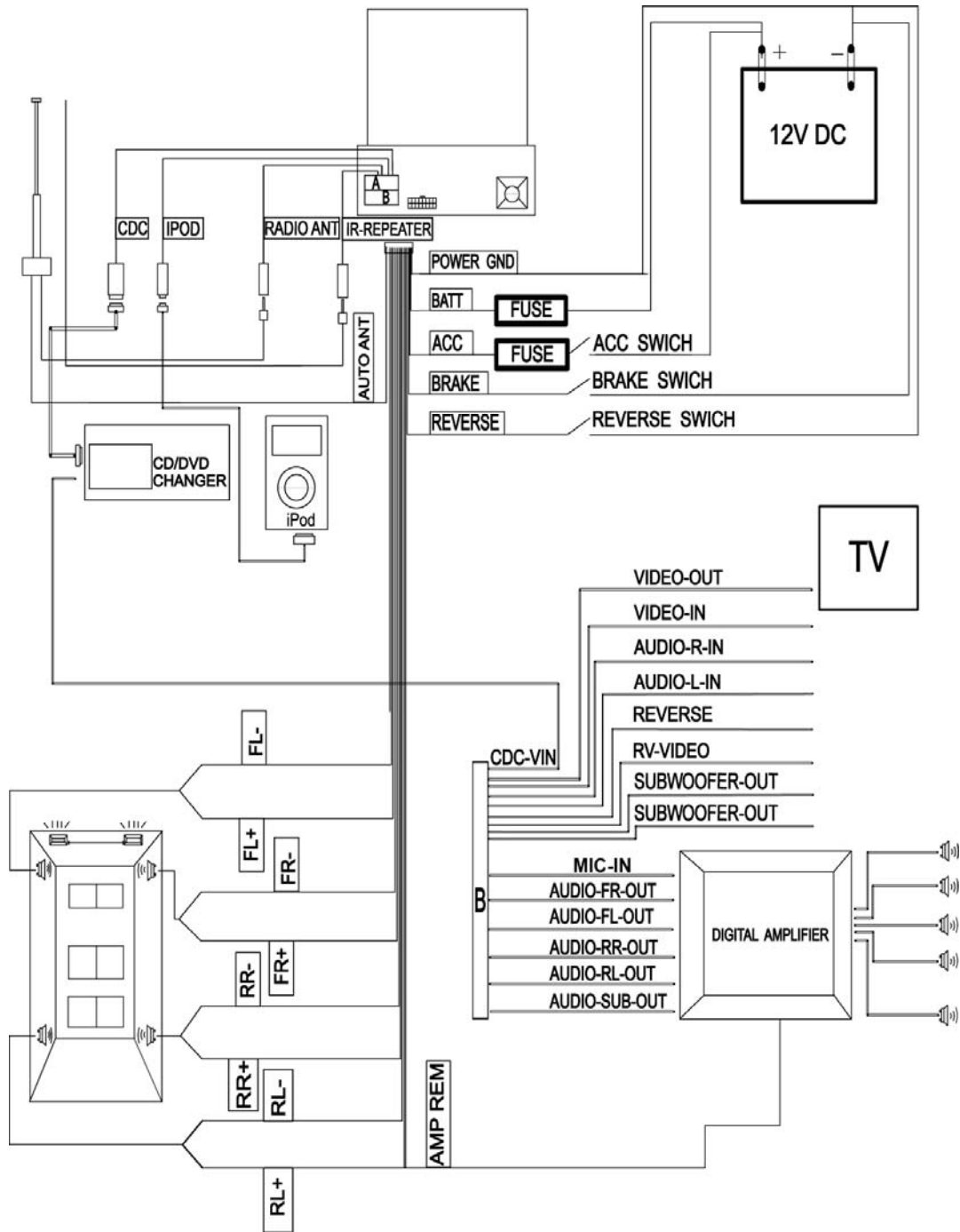

## FRONT PANEL

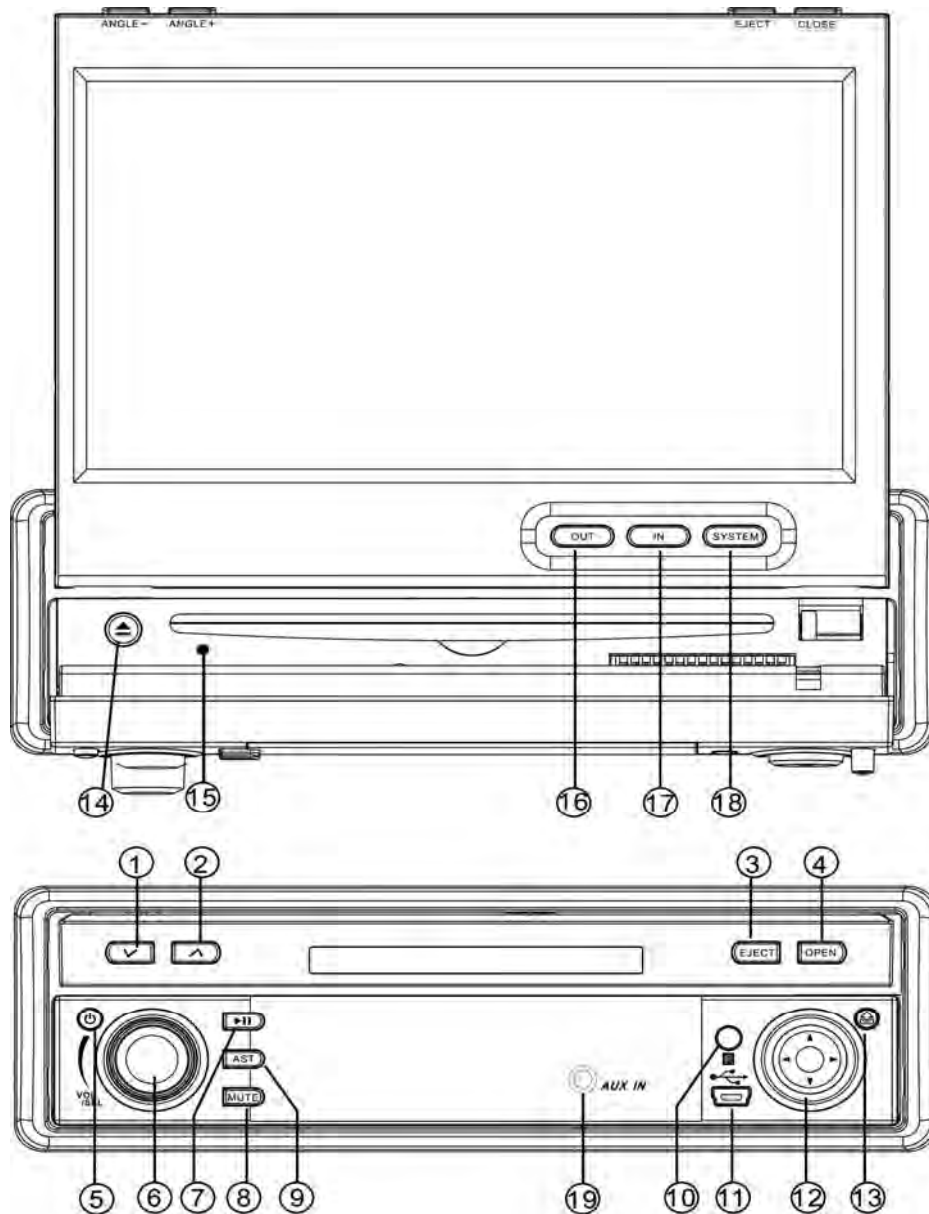

- |                   |   |
|-------------------|---|
| 1. ANGLE -        | 11. MINI USB                                |
| 2. ANGLE +        | 12. LEFT / UP / RIGHT / DOWN / ENTER / BAND |
| 3. EJECT          | 13. REL                                     |
| 4. OPEN / CLOSE   | 14. EJECT                                   |
| 5. POWER / SOURCE | 15. RESET                                   |
| 6. VOLUME / SEL   | 16. OUT                                     |
| 7. PLAY / PAUSE   | 17. IN                                      |
| 8. MUTE           | 18. SYSTEM                                  |
| 9. AST            | 19. AUX IN                                  |
| 10. REMOTE        |   |

### **1. [ANGLE -] / 2. [ANGLE +]**

Adjust the view angle of the monitor to choose the best displaying effect.

1- Continual angle adjustment

Hold on pressing the [ANGLE +] / [ANGLE -] buttons to adjust the angle of TFT monitor upward / downward by continual increasing / decreasing.

2- Single step angle adjustment

Press the [ANGLE +] / [ANGLE -] buttons to adjust the angle of TFT monitor upward / downward by singly increasing / decreasing.

### **3. [EJECT]**

When flip down the front panel, press to eject / load a disc.

### **4. [OPEN] / [CLOSE]**

When unit power off, press the [OPEN] button to turn unit on and the monitor will spread out and turn around to the last angle position.

When unit power on, press to open / close the Monitor.

1- Open the TFT Monitor

Press the [OPEN] button, the monitor will spread out and turn around to the last angle position.

2- Close the TFT Monitor

Press the [CLOSE] button, the monitor will turn downward and completely retract in.

### **5. [POWER/SOURCE]**

Press the [POWER/SOURCE] button to turn the unit ON;

Hold on pressing the button to turn the unit OFF.

When the unit in turned ON, press the [POWER/SOURCE] button to toggle between the different modes as following:

**RADIO – DVD – USB – TV – IPOD – CDC – AV IN – RADIO**

#### **NOTE:**

*The unit could be switched to DVD Mode if disc inside;*

*The unit could be switched to USB Mode if Mini USB connected;*

*The unit could be switched to IPOD Mode if iPod connected;*

### **6. [VOL/SEL]**

Rotate the button clockwise / anticlockwise to increase / decrease the volume.

Press the button vertically to return the main menu.

Hold on pressing the button vertically to enter the EQ setting as following:

**USER – POP – CLASSIC – ROCK – JAZZ – USER**

## 7. [MUTE]

Press the [MUTE] button to switch off the sound; press it again to resume to the previous volume level.

## 8. [AST]

Press to seek radio station / TV channel automatically under RADIO / TV Modes.

## 9. [▶II]

Press to pause playback when playing; press again to continue playing.

## 10. REMOTE

Infrared Remote Receiver.

## 11. MINI USB

The unit will be switched to DVD Mode automatically when USB connected, and play the songs, pictures, videos in USB.

## 12. [LEFT] / [UP] / [RIGHT] / [DOWN] / [ENTER] / [BAND]

Under the DVD Setup menu:

Press the [▼] / [▲] buttons to move the cursor upward / downward to select item.

Press the [←] / [→] buttons to move the cursor leftward / rightward to select item.

Press vertically to confirm the operation.

Under RADIO Mode:

Press the [←] / [→] buttons to switch the stored stations.

Hold on pressing the [←] / [→] buttons to fast seeking the next available channel by decreasing / increasing the tuning frequency; seeking will stop by pressing any button.

Press the [▼] / [▲] buttons to decrease / increase the frequency step by step.

Hold on pressing the [▼] / [▲] buttons to fast seeking by decreasing / increasing the tuning frequency; seeking will stop when loose the button.

Press vertically to switch the FM/AM wave band as following:

FM1 - FM2 - FM3 - AM1- AM2 - FM1

Under TV Mode:

Hold on pressing the [←] / [→] buttons to fast tuning channel forward the low / high frequency automatically.

Press the [▲] / [▼] buttons to select the stored channel upward / downward.

Press vertically to switch the TV as following:

**NTSC – PAL/BG – PAL/I – PAL/DK – NTSC**

## 13. REL

Press to flip down the front panel.

**14. [EJECT]**

When flip down the front panel, press to eject / load a disc.

**15. [RESET]**

Press to reset the unit.

**16. [OUT] / 17. [IN]**

Press the [OUT] / [IN] buttons to move the monitor forward / backward by singly step. There are 4 steps to move the monitor forward / backward totally.

**18. [SYSTEM]**

Press to enter / exit the System Parameter Setup menu.

**19. AUX IN**

Connect an external audio device to this jack to listen to the device through your car speakers.

## FRONT PANEL DISPLAY

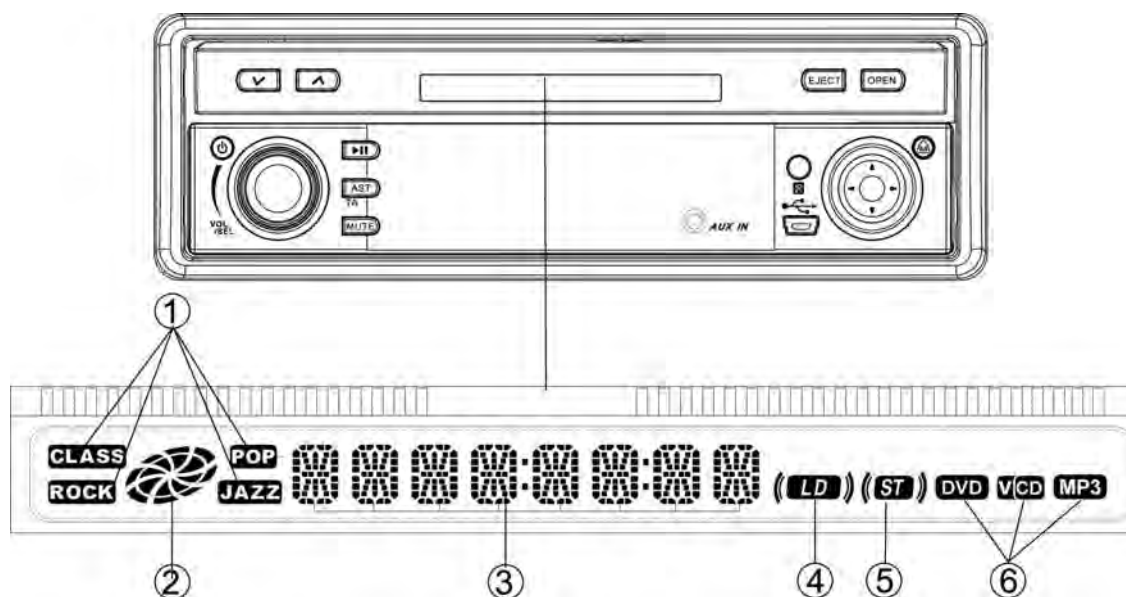

### 1. EQ Indicator:

It turns on to indicate the POP/CLASSIC/JAZZ/ROCK when corresponding setup.  
It turns off when custom setup.

### 2. Disc Icon:

It rotates when playing disc under the DVD Mode.

### 3. Main Display Area:

Display the information such as working mode, characters, playback time & number of track, radio frequency etc.

### 4. LOUD Icon:

It displays when the LOUD function on.  
It disappears when the LOUD function off.

### 5. ST Icon:

It displays when the STEREO function on.  
It disappears when the STEREO function off.

### 6. Disc Type Indicator:

It turns on to indicate DVD, CD, VCD, and MP3 when playing corresponding discs.

## REMOTE CONTROL

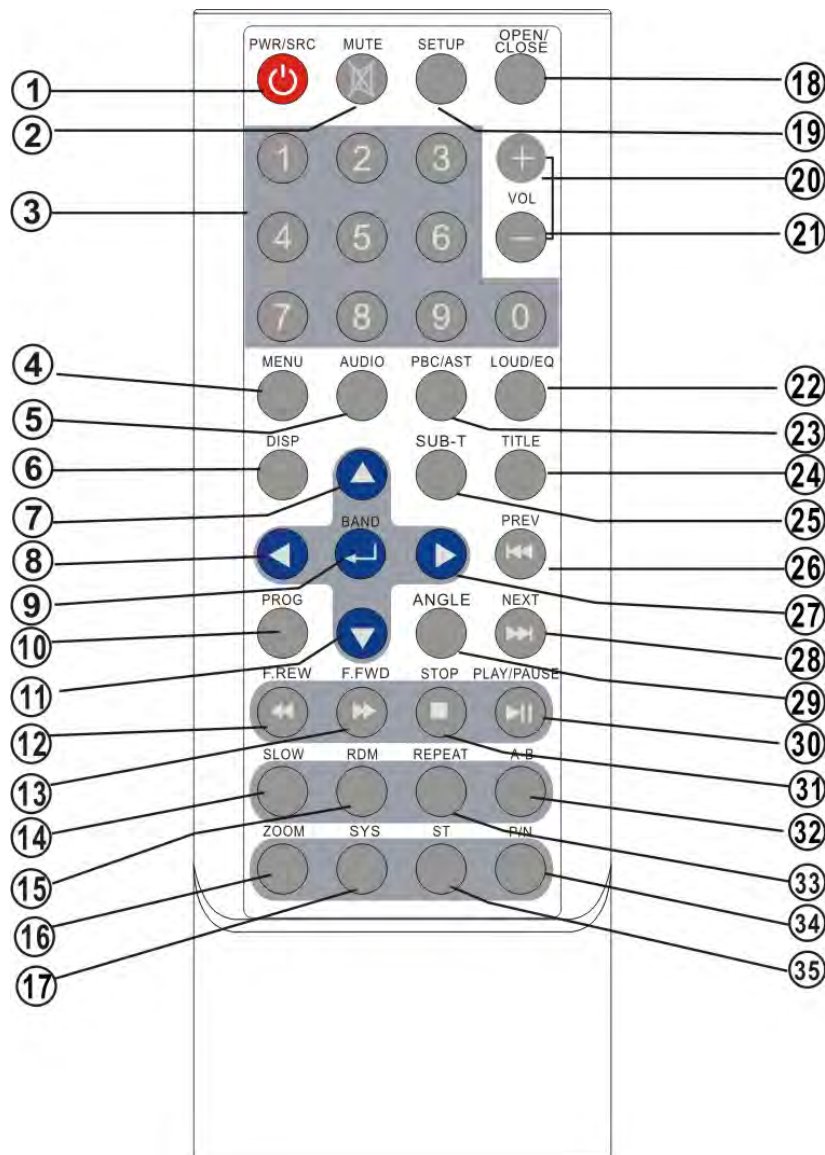

1. POWER / SOURCE
2. MUTE
3. NUMBER BUTTONS
4. MENU
5. AUDIO
6. DISPLAY
7. UP
8. LEFT
9. ENTER / BAND
10. PROGRAM
11. DOWN
12. F.REW

13. F.FWD
14. SLOW
15. RANDOM
16. ZOOM
17. SYSTEM
18. OPEN / CLOSE
19. SETUP
20. VOLUME +
21. VOLUME -
22. LOUD / EQ
23. PBC / AST
24. TITLE

25. SUBTITLE
26. PREVIOUS
27. RIGHT
28. NEXT
29. ANGLE
30. PLAY / PAUSE
31. STOP
32. A-B
33. REPEAT
34. PAL / NTSC
35. STEREO

## 1. [POWER/SOURCE]

Same functions as key on front panel.

## 2. [MUTE]

Press the [MUTE] button to switch off the sound; press it again to resume to the previous volume level.

## 3. [NUMBERS 0~9]

For 1~6, press these buttons to store the current radio station or recall the stored station under the Radio Mode.

For 0~9, press these buttons to select the tracks, and input the code.

## 4. [MENU]

Press to return to the boot menu when playing DVD disc.

Press to select PBC on / off when playing VCD disc.

## 5. [AUDIO]

Press to select dialogue language when playing DVD disc.

Press to select left audio channel, right audio channel or stereo when playing VCD disc.

## 6. [DISPLAY]

Press to display current playback information when playing DVD disc.

## 7. [^] / 8. [<] / 11. [v] / 27. [>] Direction Key

Under the DVD Setup menu:

Press the [v] / [^] buttons to move the cursor upward / downward to select item.

Press the [<] / [>] buttons to move the cursor leftward / rightward to select item.

Press vertically to confirm the operation.

Under RADIO Mode:

Press the [<] / [>] buttons to switch the stored stations.

Hold on pressing the [<] / [>] buttons to fast seeking the next available channel by decreasing / increasing the tuning frequency; seeking will stop by pressing any button.

Press the [v] / [^] buttons to decrease / increase the frequency step by step.

Hold on pressing the [v] / [^] buttons to fast seeking by decreasing / increasing the tuning frequency; seeking will stop when loose the button.

Under TV Mode:

Hold on pressing the [<] / [>] buttons to fast tuning channel forward the low / high frequency automatically.

Press the [^] / [v] buttons to select the stored channel upward / downward.

### **9. [BAND/ENTER]**

In radio mode, press the [BAND] button to switch the wave band as following:

FM1 - FM2 - FM3 - AM1- AM2 - FM1

Press vertically to switch the TV as following:

**NTSC – PAL/BG – PAL/I – PAL/DK – NTSC**

In DVD mode, press the [ENTER] button to confirm the Setup Menu.

### **10. [PROGRAM]**

Press to enter / exit the PROGRAM Function when playing the VCD, CD, MP3 disc.

### **12. [F.REW]**

Press to select fast reverse with different speed.

### **13. [F.FWD]**

Press to select fast forward with different speed.

### **14. [SLOW]**

Press to activate slow motion playback. (DVD Mode only)

### **15. [RANDOM]**

Press to turn RAMDOM function on / off when playing CD / VCD disc (PBC OFF).

### **16. [ZOOM]**

Press to magnify the picture display when play DVD, VCD disc.

### **17. [SYSTEM]**

Press to enter / exit the System Parameter Setup menu.

### **18. [OPEN/CLOSE]**

Press to open / close the monitor.

### **19. [SETUP]**

Press to enter the DVD SETUP menu.

### **20. [VOL+] / 21. [VOL-]**

Press to increase / decrease the volume.

### **22. [LOUD/EQ]**

Press to adjust the EQ setting as following:

**USER – POP – CLASSIC – ROCK – JAZZ – USER**

Hold on pressing to turn the LOUD function on / off.

**23. [PBC/AST]**

Press to turn the PBC function on / off when playing VCD disc.

Hold on pressing to seek radio station / TV channel automatically under RADIO / TV Modes.

**24. [TITLE]**

Press to enter the title menu when playing DVD disc.

**25. [SUB-T]**

Press to select the subtitle language when playing DVD disc.

**26. [PREVIOUS]**

Press to skip to play the pervious track.

**28. [NEXT]**

Press to skip to play the next track.

**29. [ANGLE]**

Press the [ANGLE] button during playback to select different viewing angles with interactive DVD media.

**30. [PLAY/PAUSE]**

Press to pause the playback when playing; press again to continue playing.

**31. [STOP]**

Press to stop the playback.

**32. [A-B]**

Press to setup A-B repeat playing.

**33. [REPEAT]**

Press to select the chapter / title / disc to repeat playing.

**34. [P/N]**

Press the button to switch the video output (PAL/NTSC) when playing DVD disc.

**35. [STEREO]**

Press to turn the stereo on / off under Radio Mode.

## REPLACING THE BATTERIES

If the remote control has no function or if the operating range reduced, replace the old battery with new one.

1. Pull out the battery holder. Follow the arrow 1 slide it to the right toward the battery while at the same time pull the battery holder away from the remote control.

2. Place the new battery. Place the new lithium battery with the (+) side up.

3. Push the holder back. Using the finger to push in the holder back until the locking sound is heard.

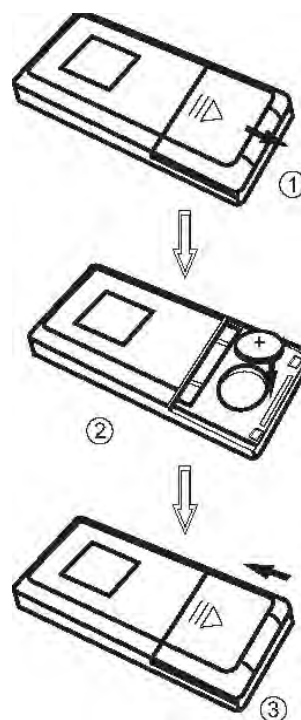

## **BASIC OPERATIONS**

### **Startup**

Press the [POWER/SOURCE] button on the panel or remote control to startup the power, the TFT monitor will spread out automatically and the system return to the working Mode when last turn off.

### **Turnoff**

Hold on pressing the [POWER/SOURCE] button on the panel or remote control to turnoff the power, the TFT monitor will retract automatically.

### **NOTE:**

*Close the ACC without turnoff, the unit will turn off automatically; and the TFT monitor will retract within 10 seconds automatically to protect the TFT monitor. Start the ACC again, the unit will startup and return to the last working Mode automatically, but the monitor does not spread out.*

### **Working Mode**

When the unit in turned ON, press the [POWER/SOURCE] button to toggle between the different modes as following:

**RADIO – DVD – USB – IPOD – CDC – AV IN – AUX –RADIO**

### **NOTE:**

*The unit could be switched to DVD Mode if disc inside;  
The unit could be switched to USB Mode if Mini USB connected;  
The unit could be switched to IPOD Mode if iPod connected;*

### **Detachable Front Panel**

The front panel is detachable.

Taking out the front panel, the unit will turnoff automatically and the TFT monitor will retract after 2 mins automatically.

### **NOTE:**

*1, don't make any operation within 2 mins.  
2, this function is burglarproof for unit security.*

### Auto Antenna Control

Connect the auto antenna control wire AUTO\_ANT (see Wiring Diagram); the antenna will lift when the unit startup; it will descend when the unit turnoff.

### Brake Control

It is necessary to connect the Brake Control wire to the Hand-brake switch of the car. While driving, the TFT monitor will display the alarm picture (see as follows) in order to ensure the safety.

Under the Rear View Mode, the Brake Control function is no effective.



### Protection of the TFT Monitor

During the movement of the TFT monitor, if it is halted by force, then the unit will begin self-protection to prevent from any damage on the motorized mechanical structure. Press the [OPEN] button or shut down the ACC and then restart, the TFT monitor will act as the follow list to recover; if not, then please consult with an authorized service center.

Halt	Self-protection	Press the [OPEN] button	Shut down the ACC and restart
While extending	Retraction	Extending	Retraction
While retraction	Stop at the halt place and retract after 3 seconds	Extending	Retraction
While turning upward	Turning downward and retraction	Extending	Turning downward and retract ion
While turning downward	Stop at the halt place	Turning downward and retract ion	Turning downward and retract ion

## TOUCH SCREEN OPERATIONS

### TOUCH SCREEN CALIBRATE

When "Power Off", press the buttons 1, 2, 3, 4, 5, [BAND] of remote control to enter the CALIBRATE page:

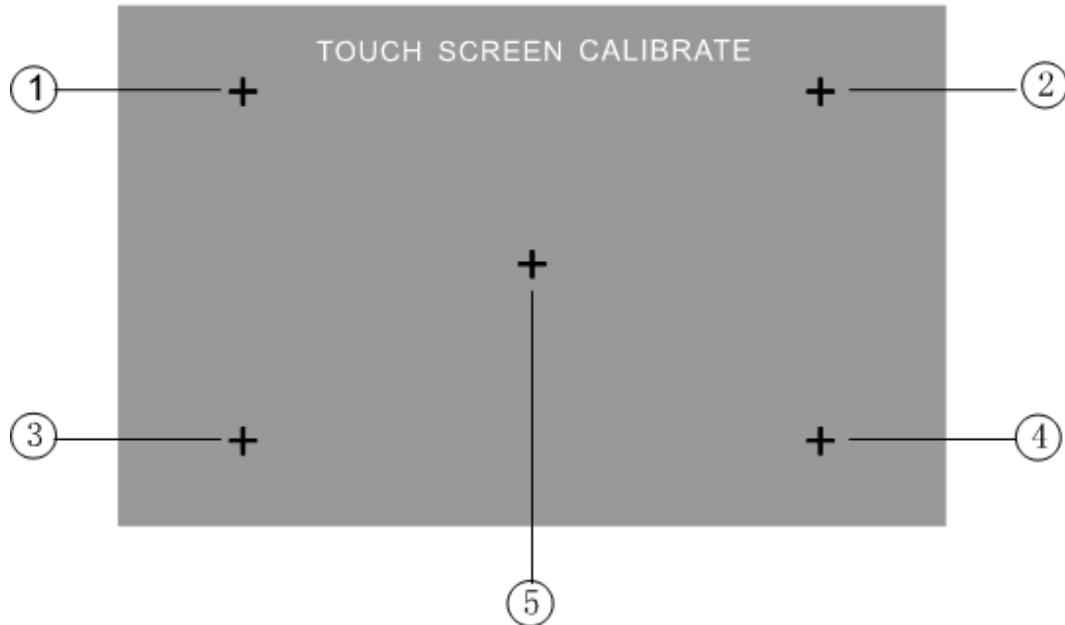

To touch the points from 1 to 5 until the points change to brighter by using a ballpoint pen or pencil.

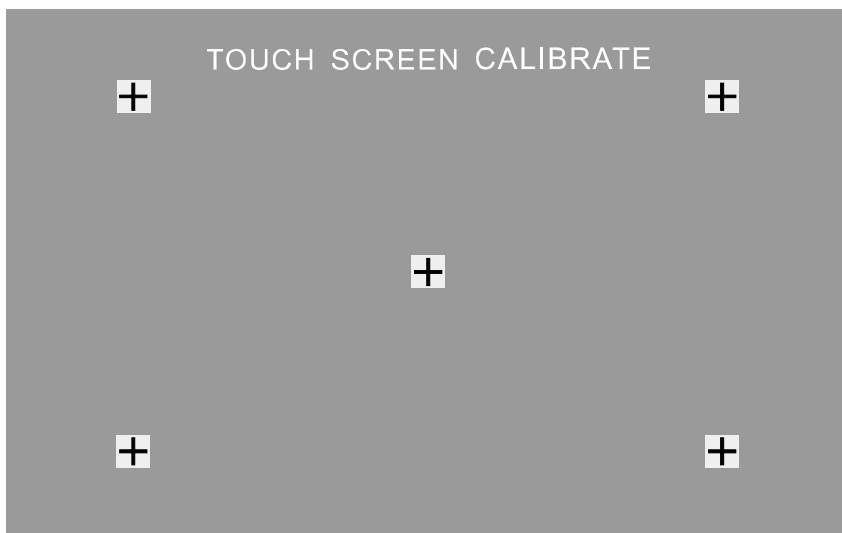

After all 5 points change to brighter, the unit would finish the CALIBRATE and power off again. Then the Touch Screen is restored to their default positions.

## MAIN MENU

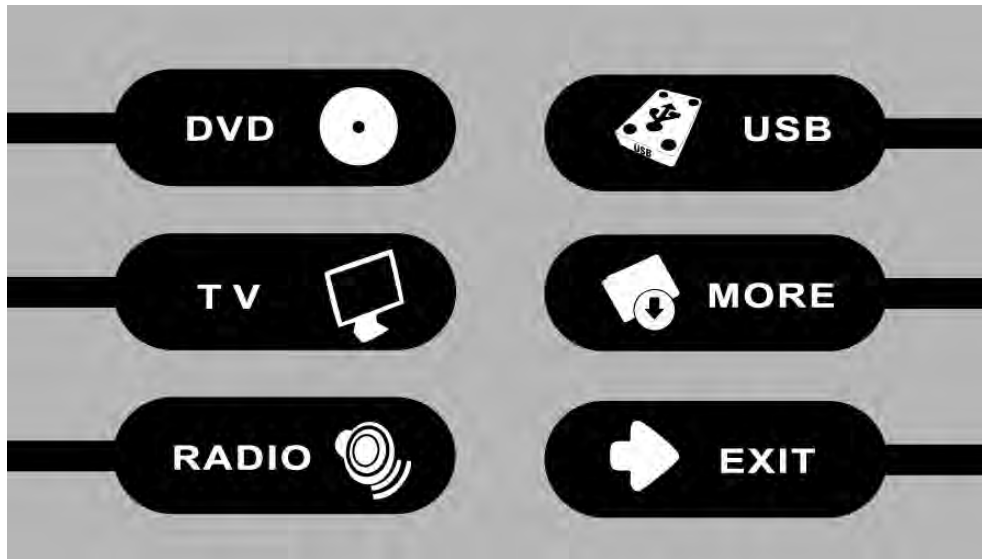

Touch the icon "MORE" to enter the 2<sup>nd</sup> page of main menu:

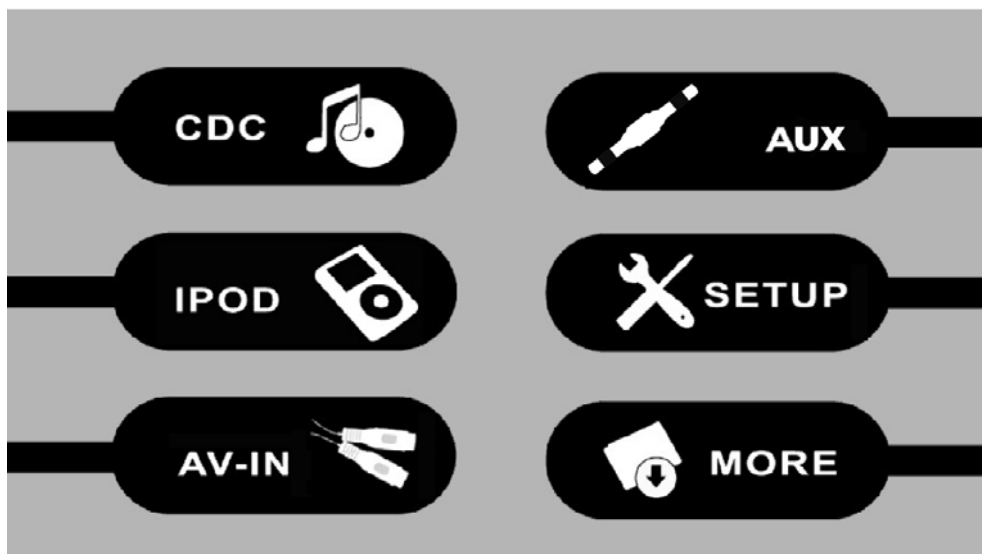

## **RADIO OPERATIONS**

Touch the icon "RADIO" to enter the **1st operation page of RADIO Mode:**

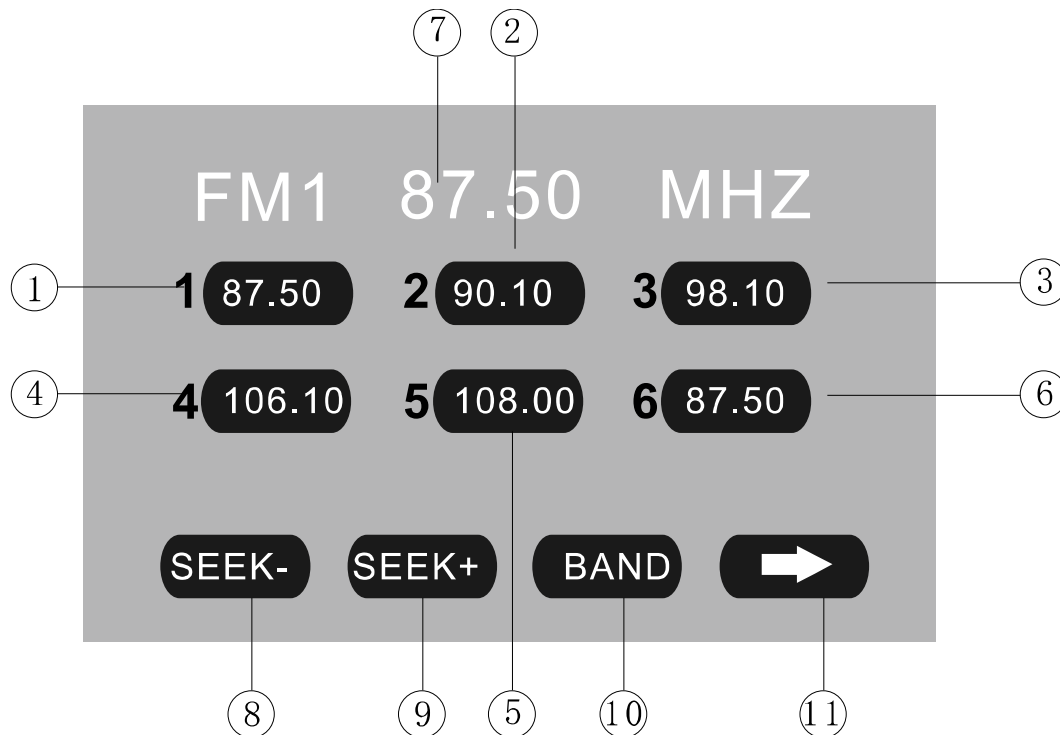

### **1~6. STORED CHANNEL**

#### **Manual Store Radio Station**

Hold on touching the icon, you can store current radio frequency to the stored channel. For example, the current frequency is 98.5MHZ, by hold on touching the icon 1, you can store the radio station of 98.5MHZ to the channel 1.

After manual store radio station, the former stored stations will be instead.

In each wave band, the number icons 1 to 6 represent the stored radio stations.

To hold on pressing the number buttons 1~6 of remote control performs same operation.

#### **Recall a Preset Station**

Touch the icon 1~6 to recall the corresponding stored station in M1~M6 channels.

To press the number buttons 1~6 of remote control performs same operation.

### **7. FREQUENCY**

#### **8. SEEK - / 9. SEEK +**

Touch the icon to seek the next available channel by increasing / decreasing the tuning frequency.

Press any button to stop seeking.

Seeking will stop automatically when seek an available channel then play this station.

The unit will stop on the beginning frequency if no available station after seeking one cycle.

To hold on pressing [>] / [<] buttons of remote control performs same operation.

## 10. BAND

Touch the icon to switch the FM/AM wave band as following:

FM1 - FM2 - FM3 - AM1- AM2 - FM1

To press the [BAND] button of panel or remote control performs same operation.

## 11. NEXT PAGE

Touch the icon to enter the 2<sup>nd</sup> page of RADIO Mode:

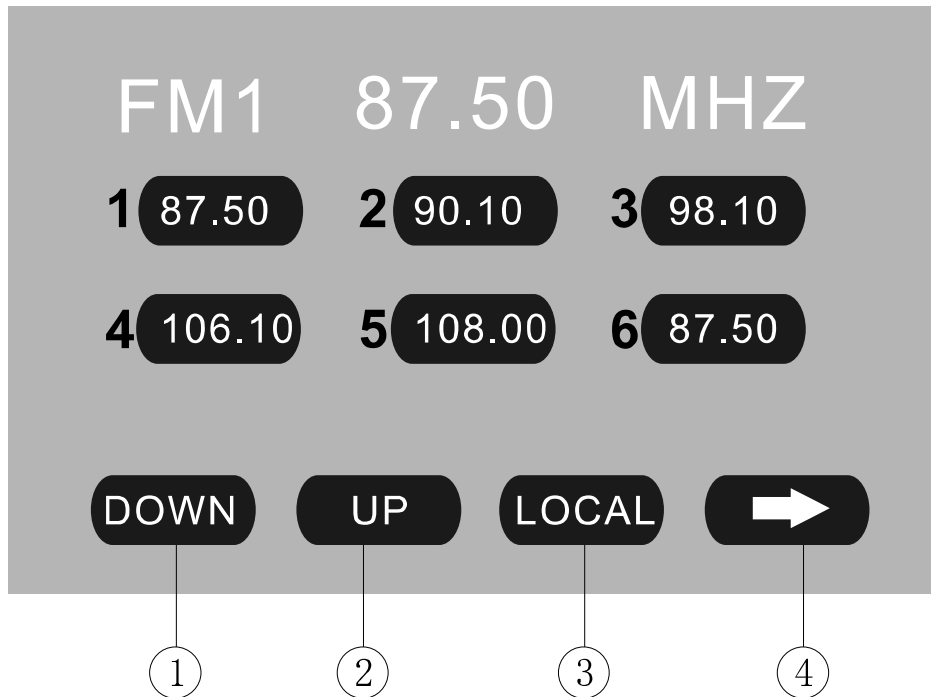

### 1. DOWN / 2. UP

Touch the icons to adjust the frequency downward / upward by step decreasing / increasing.

Hold on touching the icons has same function with [SEEK-] / [SEEK+].

To press the [∇] / [∧] buttons of remote control performs same operation.

### 3. LOCAL: ON / OFF

When you are using the local searching function of LOCAL, you can only receive the radio station with strong enough signals and fine state.

### 4. NEXT PAGE

Touch the icon to enter the 3<sup>rd</sup> page of RADIO Mode:

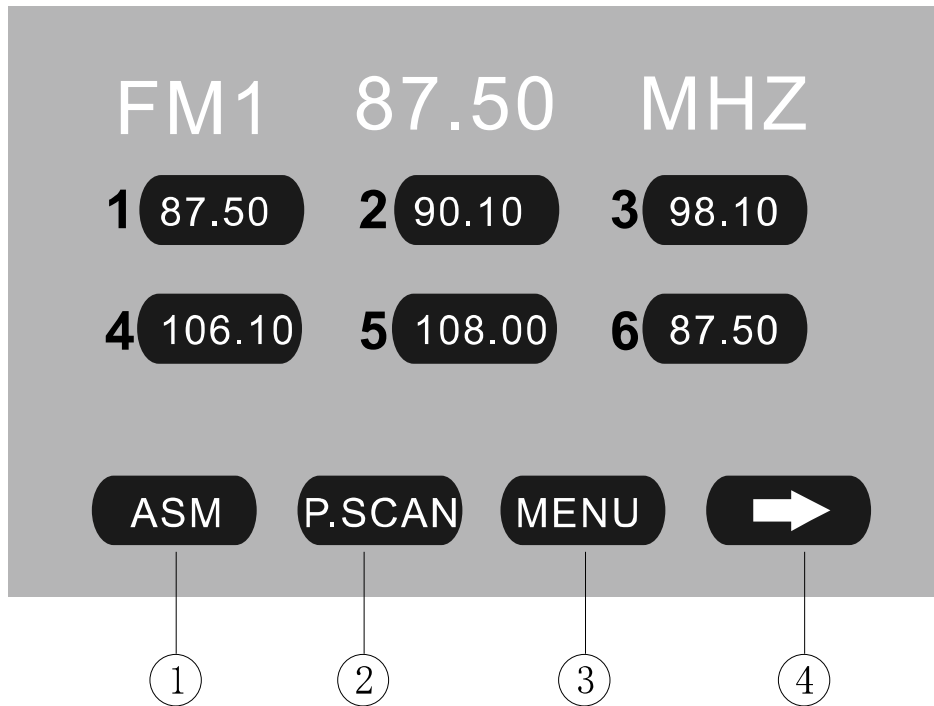

### 1. ASM

Seeking and store the stations

1. Hold on touching the icon to seek stations with the strongest signal from the lowest frequency point in the entire wave bands; press any button to stop seeking. After seeking, the former stored stations will be instead.
2. Store the received effective radio frequency to the six stored channels M1~M6.
3. The unit will play the stations one by one for few seconds; press any button to stop playing.
4. It is independent for FM & AM frequency. There are 3 wave bands of FM1、FM2、FM3 & 2 wave bands of AM1、AM2, each can store 6 radio stations, totally 30 radio stations.
5. The unit will stop on the beginning frequency if no available station after seeking one cycle.
6. To press the [AST] button of panel or hold on pressing the [PBC/AST] button of remote control performs same operation.

### 2. P.SCAN

The unit will play the stored stations one by one for few seconds from FM1, FM2, FM3, AM1, AM2; press any button to stop playing.

### 3. MENU

Touch the icon to return the main menu.

### 4. NEXT PAGE

Touch the icon to enter the 1<sup>st</sup> page of RADIO Mode.

## **DVD OPERATIONS**

Touch the icon “DVD” to enter the DVD Mode if disc inside.

The unit will switch to DVD Mode automatically if loading disc.

The unit will switch to RADIO Mode automatically if ejecting disc.

### **1st operation page of DVD Mode:**

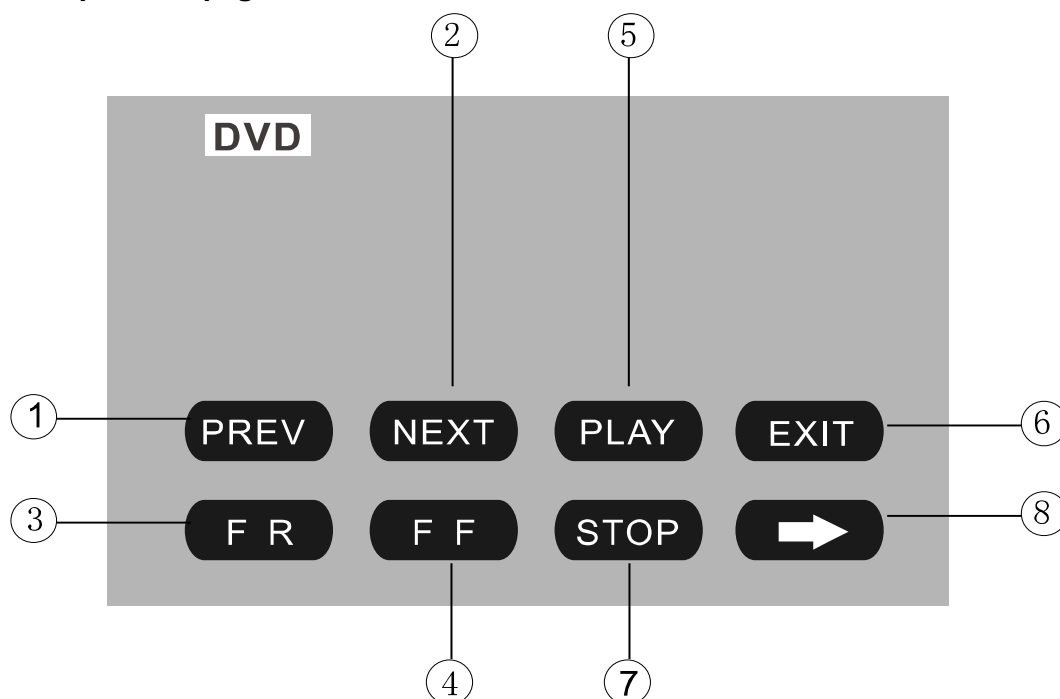

#### **1. PREV / 2. NEXT**

Touch the icon to go to the pervious / next chapter, track or song.

To press the [Previous] / [Next] buttons of remote control performs same operation.

#### **3. F.REV / 4. F.FWD**

Touch the icon to select fast reverse / forward search. Touch the [PLAY] icon to resume to normal playback.

To press the [F.REV] / [F.FWD] buttons of remote control performs the same operation.

#### **5. PLAY**

Touch the icon to play or pause the disc.

To press the [PLAY/PAUSE] button of panel or remote control performs the same operation.

#### **6. EXIT**

Touch the icon to exit the TOUCH ICONS display.

## 7. STOP

During movie playback, touch the icon once; the DVD player memorizes the location where you stopped (touch the [PLAY] icon to resume playing from the memorized location). If you touch the icon twice, the playback will start from the beginning of the disc when you touch the [PLAY] icon.

To press the [STOP] button of remote control performs the same operation.

## 8. NEXT PAGE

Touch the icon to enter the 2<sup>nd</sup> page of DVD Mode:

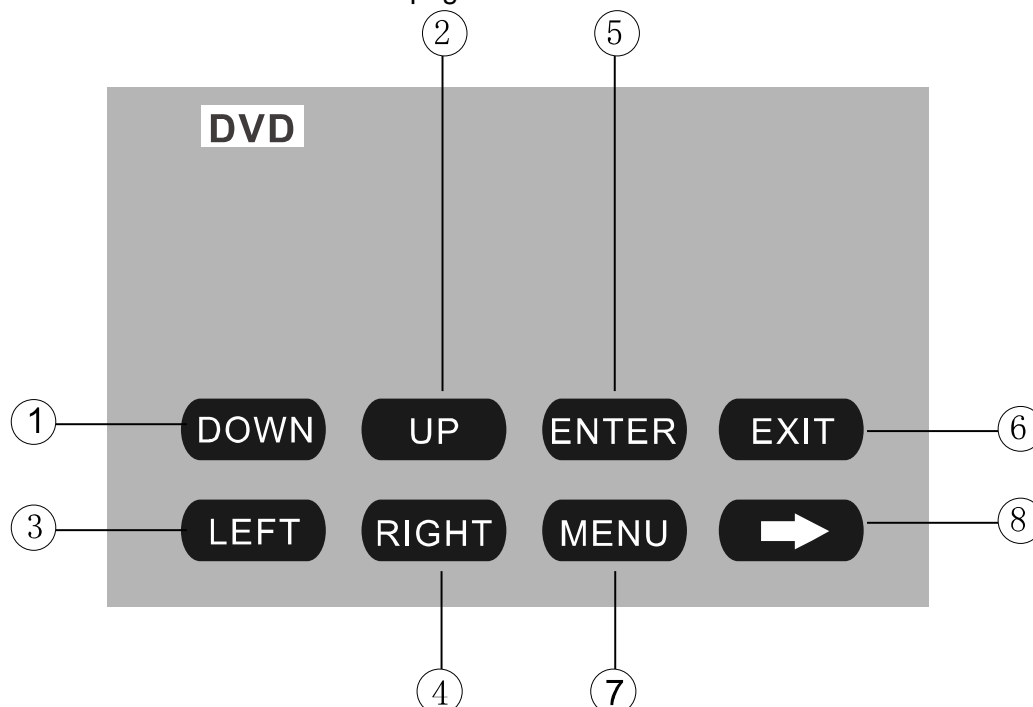

### 1~4. DOWN / UP / LEFT / RIGHT

Touch the direction icons (UP / DOWN / LEFT / RIGHT) to move the cursor to the selected item.

To press the direction buttons (UP / DOWN / LEFT / RIGHT arrow) of remote control performs same operation.

### 5. ENTER

Touch the icon to confirm the selection.

To press the [ENTER] button of remote control performs same operation.

### 6. EXIT

Touch the icon to exit the TOUCH ICONS display.

### 7. MENU

Touch the icon to return the main menu.

### 8. NEXT PAGE

Touch the icon to enter the 1<sup>st</sup> page of DVD Mode.

## **USB OPERATIONS**

Touch the icon "USB" to enter the USB Mode if USB connected.

The unit will switch to USB Mode automatically if connecting USB.

When disconnecting USB, the unit will switch to RADIO Mode automatically if there is no disc in the unit; and the unit will switch to DVD Mode automatically if there is a disc inside.

Under USB Mode, all operations are same as DVD operations.

## TV OPERATIONS

Touch the icon "TV" to enter the TV Mode:

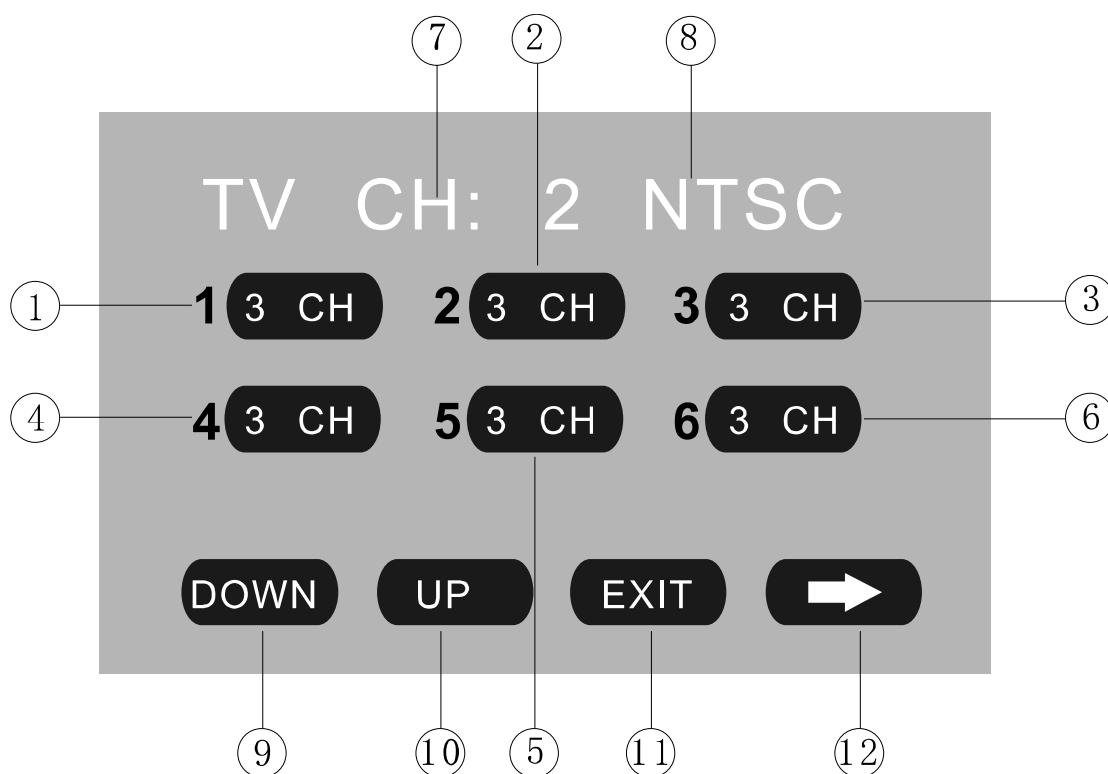

### **1~6. STORED CHANNEL**

#### **Manual Store TV Station**

Hold on touching the icon, you can store current station to the stored channel. For example, the current station is 3 CH, by hold on touching the icon 1, you can store the radio station of 3 CH, to the channel 1.

After manual store TV station, the former stored stations will be instead.

The number icons 1 to 6 represent the stored stations.

To hold on pressing the number buttons 1~6 on the panel performs same operation.

#### **Recall a Preset Station**

Touch the icon 1~6 to recall the corresponding stored station in M1~M6 channels.

To press the number buttons 1~6 on the panel performs same operation.

### **7. TV CHANNEL**

### **8. AUDIO FORMAT**

### **9. DOWN / 10. UP**

After [ASM] seeking, touch the icon to select the stations downward / upward.

To press the [^] / [v] buttons of remote control performs same operation.

### 11. EXIT

Touch the icon to exit the TOUCH ICONS display.

### 12. NEXT PAGE

Touch the icon to enter the 2<sup>nd</sup> page of TV Mode:

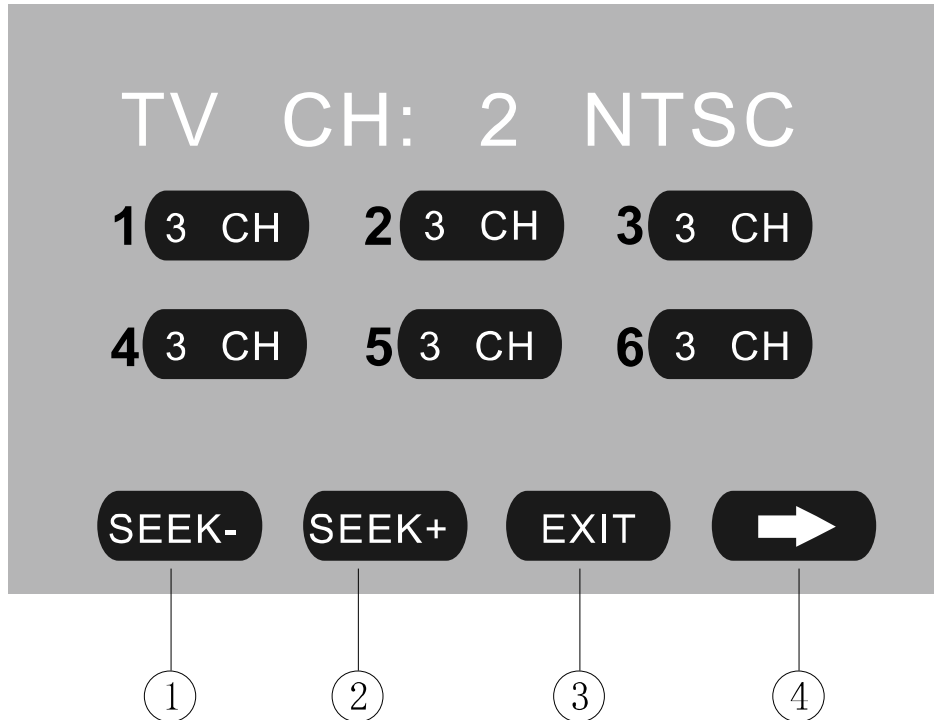

#### 1. SEEK – / 2. SEEK +

Touch the icon to seek the next available channel by increasing / decreasing the tuning frequency.

Press any button to stop seeking.

Seeking will stop automatically when seek an available channel then play this station. The unit will stop on the beginning frequency if no available station after seeking one cycle.

To hold on pressing [>] / [<] buttons of panel or remote control performs same operation.

#### 3. EXIT

Touch the icon to exit the TOUCH ICONS display.

#### 4. NEXT PAGE

Touch the icon to enter the 3<sup>rd</sup> page of TV Mode:

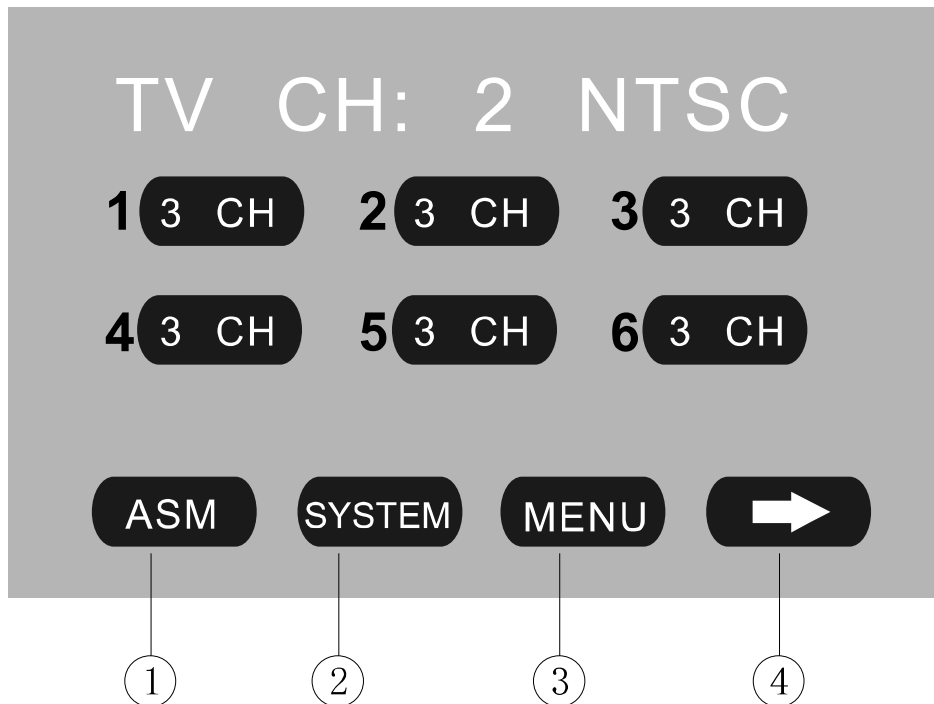

### 1. ASM

#### **Seeking and store the stations.**

1. Touch the icon to seek all stations with the strongest signal from the lowest frequency point; press any button to stop seeking. After seeking, the former stored stations will be instead.
2. Store the received effective TV stations to the six stored channels M1~M6.
3. The unit will stop on the beginning frequency if no available station after seeking one cycle.
4. To press the [PBC/AST] button of remote control performs same operation.

### 2. SYSTEM

Touch the icon to switch the TV as following:

**NTSC – PAL/BG – PAL/I – PAL/DK – NTSC**

### 3. MENU

Touch the icon to return the main menu.

### 4. NEXT PAGE

Touch the icon to enter the 1<sup>st</sup> page of TV Mode.

#### **\* Select the Station Directly**

Press the number buttons of remote control to select the station directly.  
For example, press 2 to select station 2; press 1 & 2 to select station 12.

## IPOD OPERATIONS

Touch the icon "IPOD" to enter the IPOD Mode if iPod connected.

The unit will switch to IPOD Mode automatically if connecting iPod.

The unit will switch to RADIO Mode automatically if disconnecting iPod.

### **NOTE:**

***It is available for iPod operations with an additional iPod cable which is optional accessory.***

### **Music Operation**

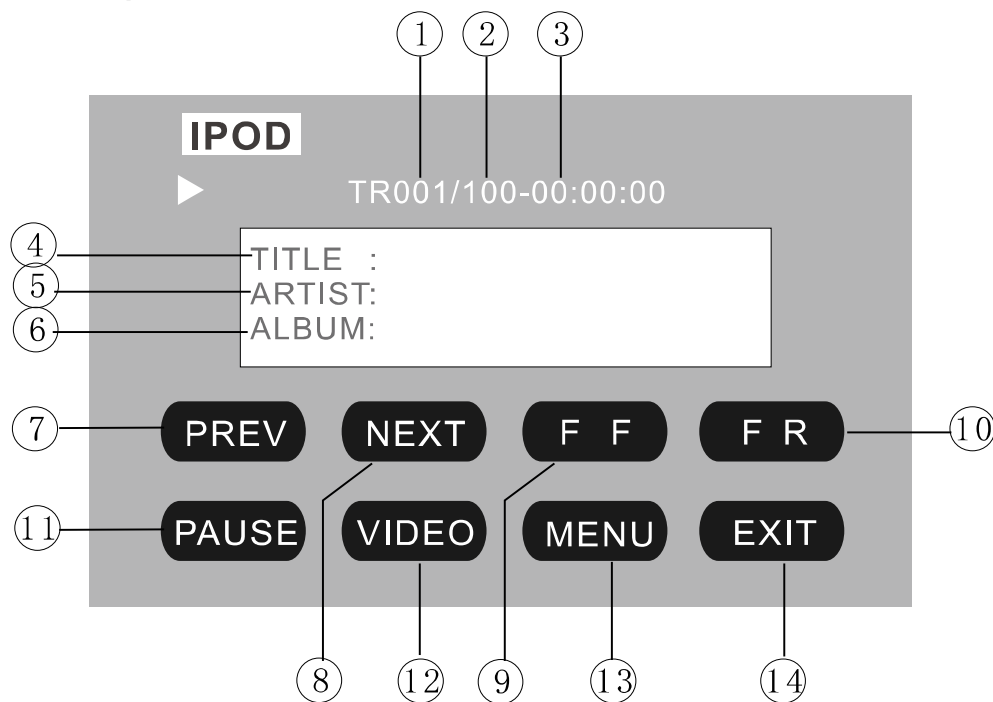

**1.** The Number of Playing Song

**2.** The Total Songs in Play List

**3.** The Playing Time

**4.** The Name of Playing Song

**5.** The Name of Artist

**6.** The Name of Album

**7.** PREV / **8.** NEXT

Touch the icon to go to the pervious / next chapter, track or song.

To press the [PREVIOUS] / [NEXT] buttons of remote control performs same operation.

**9.** F.REV / **10.** F.FWD

Hold on touching the icon to select fast reverse / forward search. Touch the [PLAY] to resume to normal playback.

To press the [F.REV] / [F.FWD] buttons of remote control performs the same operation.

### 11. PLAY / PAUSE

Touch the icon to play or pause the disc.

To press the [PLAY/PAUSE] button of panel or remote control performs the same operation.

### 12. VIDEO

Touch the icon to switch to the VIDEO operation.

### 13. MENU

Touch the icon to return the main menu.

### 14. EXIT

Touch the icon to exit the TOUCH ICONS display.

### Video Operation

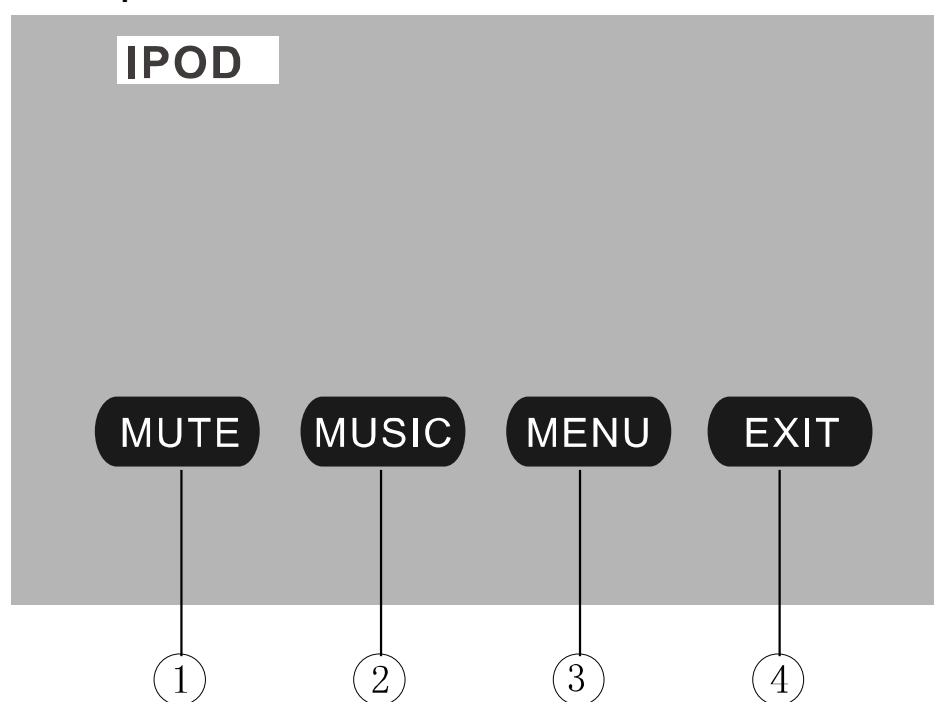

#### 1. MUTE

Touch the icon to switch off the sound; touch it again to resume to the previous volume level.

#### 2. MUSIC

Touch the icon to switch to the MUSIC operation.

#### 3. MENU

Touch the icon to return the main menu.

#### 4. EXIT

Touch the icon to exit the TOUCH ICONS display.

## **AV IN OPERATIONS**

Touch the icon "AV IN" to enter the AV IN Mode:

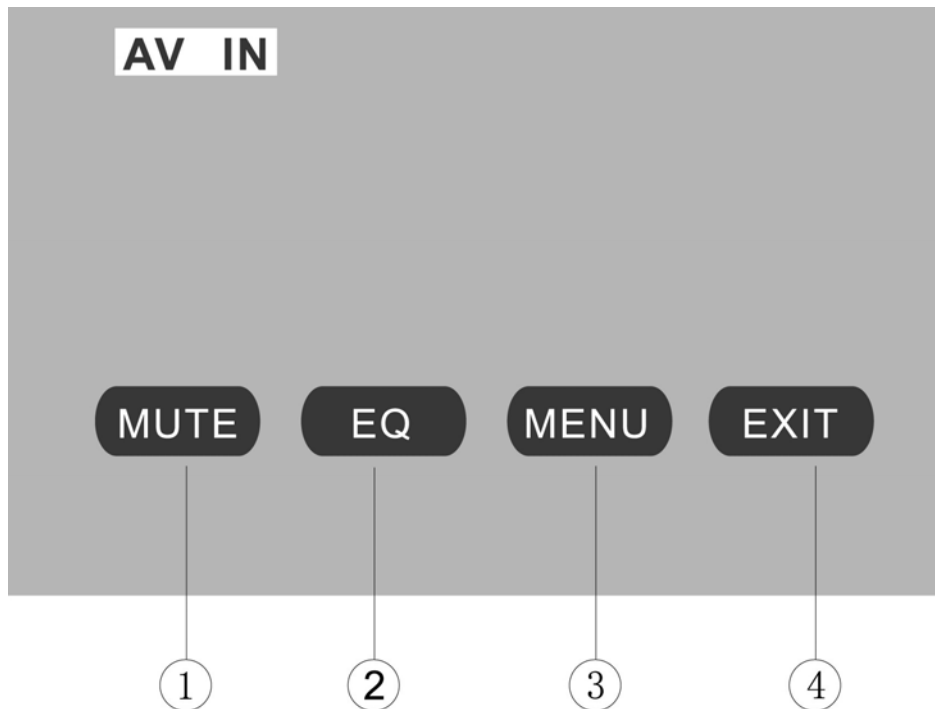

### **1. MUTE**

Touch the icon to switch off the sound; touch it again to resume to the previous volume level.

### **2. EQ**

The user can set to adjust the audio output to your preference:

**USER – POP – CLASSIC – ROCK – JAZZ – USER**

### **3. MENU**

Touch the icon to return the main menu.

### **4. EXIT**

Touch the icon to exit the TOUCH ICONS display.

### **NOTE:**

There are 2 RCA Audio Inputs & 1 RCA Video Input for unit.

## **AUX OPERATIONS**

Touch the icon "AUX" to enter the AUX Mode:

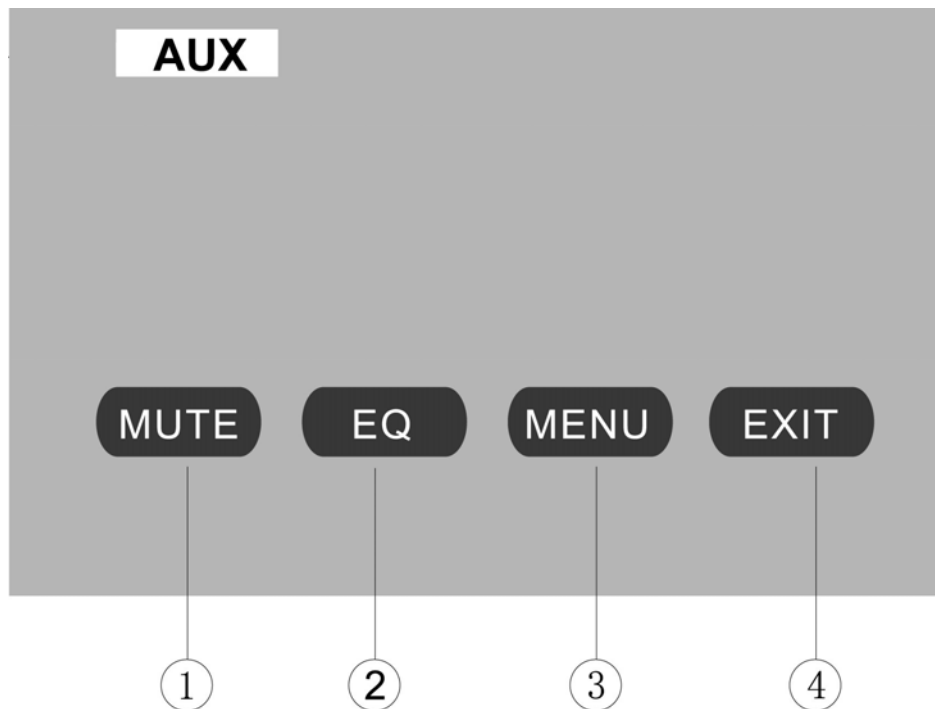

### **1. MUTE**

Touch the icon to switch off the sound; touch it again to resume to the previous volume level.

### **2. EQ**

The user can set to adjust the audio output to your preference:

**USER – POP – CLASSIC – ROCK – JAZZ – USER**

### **3. MENU**

Touch the icon to return the main menu.

### **4. EXIT**

Touch the icon to exit the TOUCH ICONS display.

### **NOTE:**

***Connect an external audio device to AUX IN jack to listen to the device through your car speakers.***

## **CDC OPERATIONS**

Touch the icon "CDC" to enter the CDC Mode if CD/DVD changer connected:

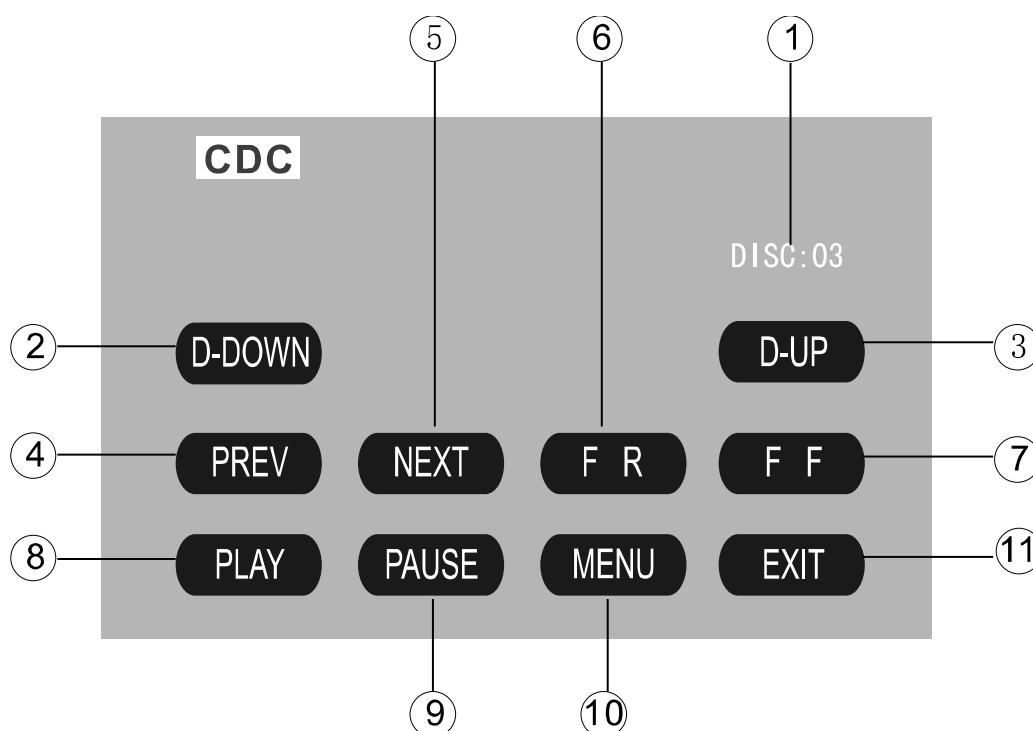

**1.** The playing DISC number

**2.** D-DOWN / **3.** D-UP

Touch the icon to change the next / previous disc to play.

**4.** PREV / **5.** NEXT

Touch the icon to go to the pervious / next chapter, track or song.

To press the [PREVIOUS] / [NEXT] buttons of remote control performs same operation.

**6.** F.REV / **7.** F.FWD

Touch the icon to select fast reverse / forward search. Touch the [PLAY] icon to resume to normal playback.

To press the [F.REV] / [F.FWD] buttons of remote control performs the same operation.

**8.** PLAY / **9.** PAUSE

Touch the icon to play or pause the disc.

To press the [PLAY/PAUSE] button of panel or remote control performs the same operation.

## 10. MENU

Touch the icon to return the main menu.

## 11. EXIT

Touch the icon to exit the TOUCH ICONS display.

### NOTE:

Touch the “CDC” icon to enter the following page if the CD/DVD changer not connected.

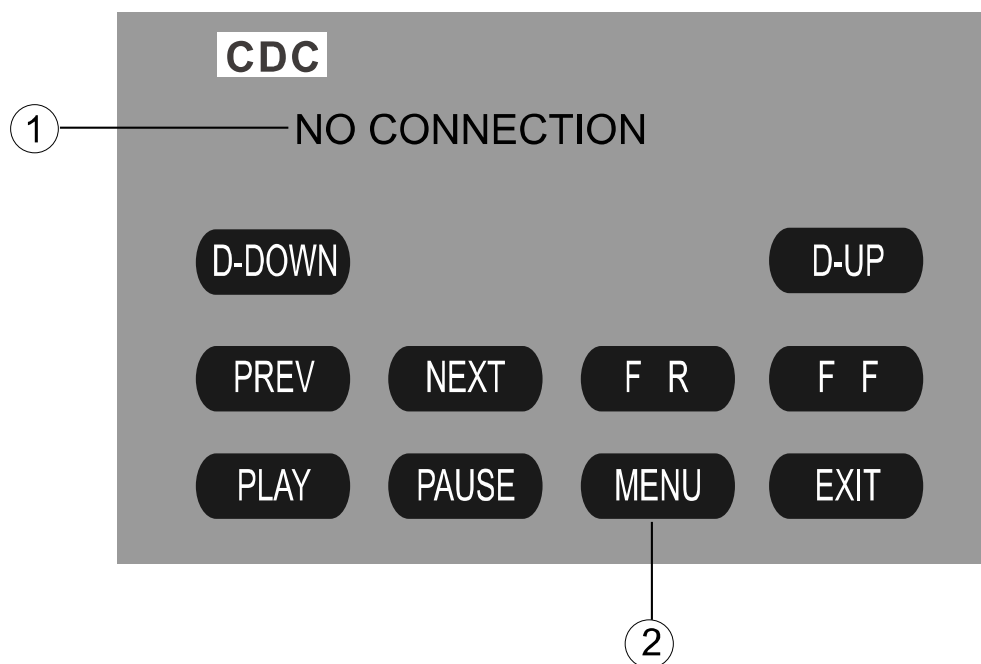

### 1. INFORMATION

It indicates that the unit does not connect the CD/DVD changer.

### 2. MENU

Touch the icon to return the main menu.

## **SYSTEM SETUP**

Touch the icon “SETUP” or press the [SYSTEM] button of panel to enter the SETUP of system parameters:

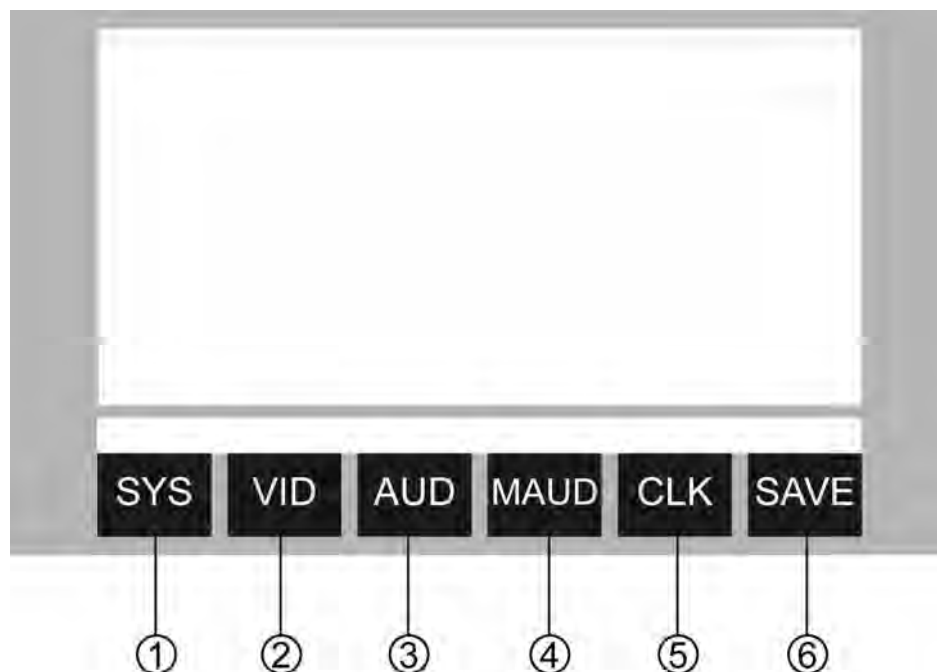

### **1. SYSTEM SETUP**

### **2. VIDEO SETUP**

### **3. AUDIO SETUP**

### **4. MORE AUDIO SETUP**

### **5. CLOCK SETUP**

Touch the icon 1~5 to select the main menus directly.

### **6. SAVE SETTINGS**

Touch the icon 5 to save all settings and exit SETUP.

## **SETUP MENU OPERATION**

Press the [BAND] button of remote control to switch the main menus as following:

**SYSTEM – VIDEO – AUDIO – MORE AUDIO – CLOCK – SYSTEM**

Press the [v] / [^] buttons of remote control to select the item you want to change.

Press the [<] / [>] buttons of remote control to change the value of item.

Holding on pressing the [SYSTEM] button of panel to exit SETUP of system parameters.

## SYSTEM SETUP

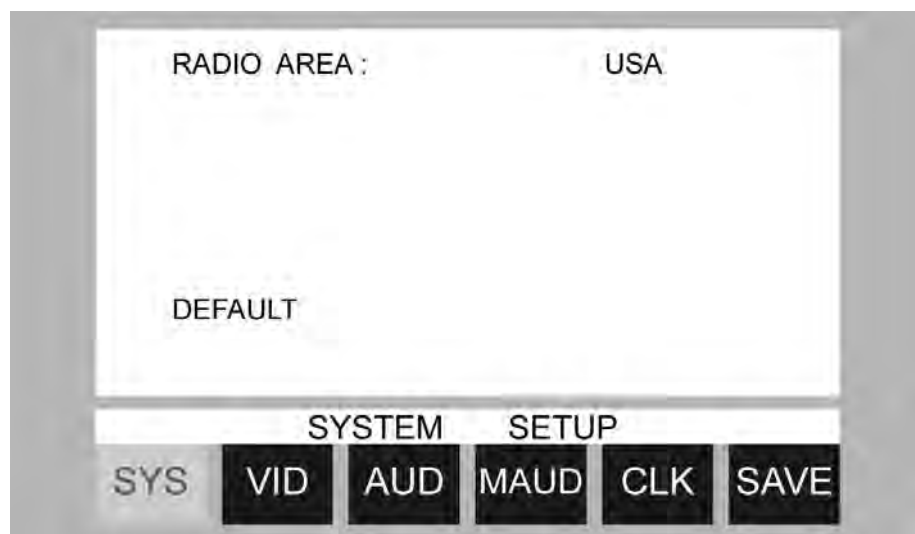

**RADIO AREA:** USA – JAPAN – OIRT – EUROPE – ASIA – USA

**DEFAULT:** the unit will restore all default settings of Sound Parameter, Picture Parameter & Tuner Parameter.

## VIDEO SETUP



**BRIGHTNESS:** 0 ~ 64

**CONTRAST:** 0 ~ 64

**COLOR:** 0 ~ 64

**HUE:** 0 ~ 64

**VIDEO TYPE:** NTSC – PAL – AUTO – NTSC

### NOTE:

It is available to setup of HUE under NTSC VIDEO TYPE only.

## AUDIO SETUP

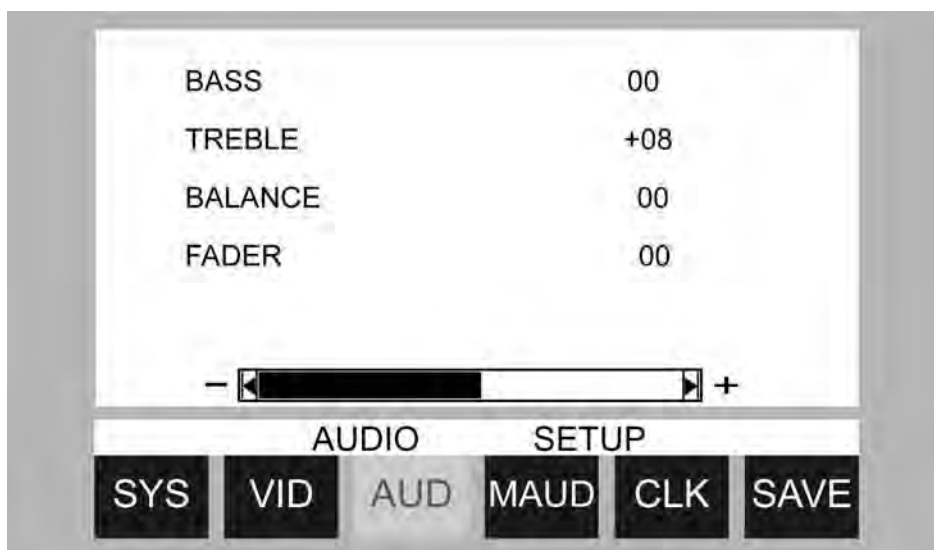

**BASS:** - 15 ~ + 15  
**TREBLE:** - 15 ~ + 15  
**BALANCE:** L 15 ~ R 15  
**FADER:** F 15 ~ R 15

## MORE AUDIO SETUP

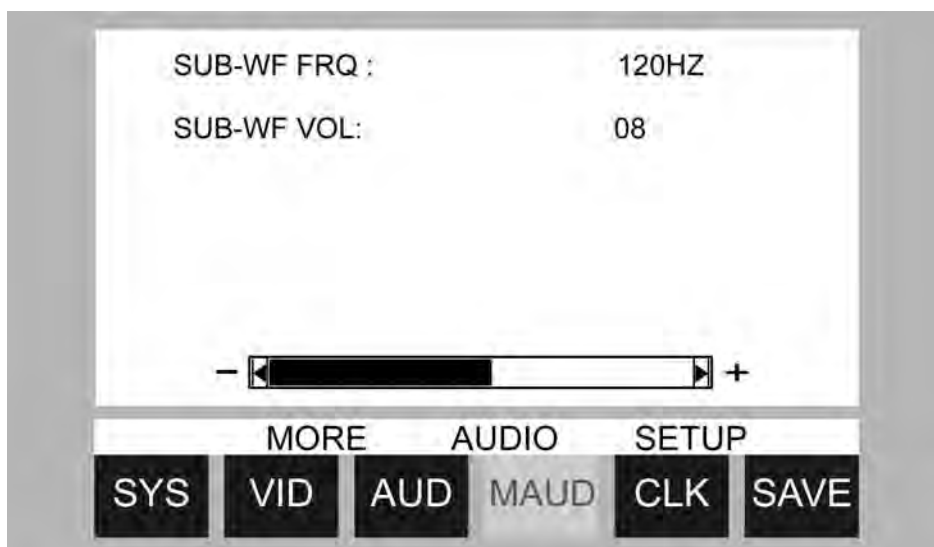

**SUB-WF FRQ:** 80HZ – 120HZ – 160HZ – OFF – 80HZ  
**SUB-WF VOL:** 0 ~ 15

## CLOCK SETUP

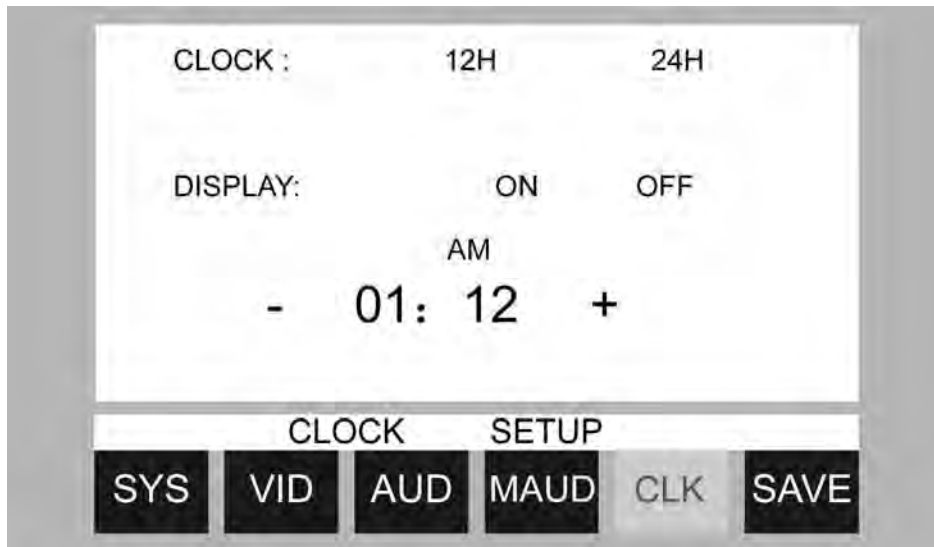

**CLOCK:** 12H / 24H  
**DISPLAY:** ON / OFF  
**HOUR:** 00 ~ 23  
**MINUTE:** 00 ~ 59

## **DVD SETUP MUNE**

### **SETUP MENU OPERATION**

Press the [SETUP] button of remote control to enter the DVD SETUP Menu.

Press the [<] / [>] buttons to switch the main menus as following:

### **SYSTEM – LANGUAGE – AUDIO – VIDEO – SPEAKER – DIGITAL**

Press the [^] / [v] buttons to enter the submenus from main menus.

Press the [^] button on the top submenu or press the [v] button on the bottom of submenu to exit the submenus to main menus.

Press the [^] / [v] buttons to select the submenus as your need.

Press the [>] or [ENTER] buttons to enter the items of submenus.

ress the [<] button to exit the items of submenus.

Press the [v] / [^] buttons to select the item you want to change.

Press the [ENTER] button to confirm the item you have selected and exit to the submenus.

Press the [SETUP] button of remote control or press the [ENTER] button on the submenu EXIT SETUP to exit the DVD SETUP Menu and save all settings.

### **NOTE:**

*Effective only DVD, USB Mode.*

## **SYSTEM MENU**

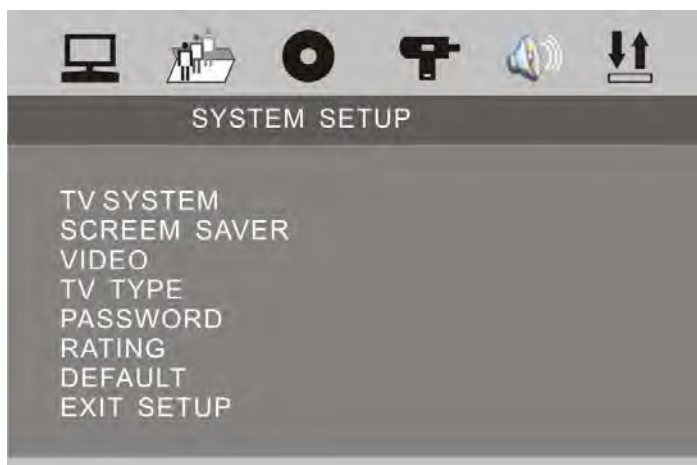

### **TV SYSTEM**

Following options are available for the TV Display:  
NTSC

### **SCREEN SAVER**

Select ON or OFF.

### **VIDEO**

Following options are available for the TV Display:

INTERLACE-YUV                  TV-RGB                  P-SCAN YPBPR                  S-VIDEO

### **TV TYPE**

Following options are available for the TV Display:

4 : 3 PS                  4 : 3 LB                  16 : 9

### **PASSWORD**

Setup the password for Parental Ratings change. The default password is 0000.

### **RATING**

Following options are available for the Parental Ratings:

1 KID SAFE                  2 G                  3 PG                  4 PG 13  
5 PG - R                  6 R                  7 NC - 17                  8 ADULT

The Parental Ratings could be changed after the correct password input.

### **DEFAULT**

The unit will restore all default settings by selecting this option.

## **LANGUAGE SETUP**



### **OSD LANGUAGE**

Following options are available for the OSD LANGUAGE:

ENGLISH	GERMAN	SPANISH	FRENCH	PORTUGUESE
ITALIAN	RUSSIAN	DUTCH	SWEDISH	KOREAN
DANISH	NORWEGIAN	POLISH	HUNGARIAN	

### **AUDIO LANGUAGE**

Following options are available for the AUDIO LANGUAGE:

ENGLISH	GERMAN	SPANISH	FRENCH	PORTUGUESE
ITALIAN	RUSSIAN	DUTCH	SWEDISH	KOREAN
DANISH	NORWEGIAN	POLISH	HUNGARIAN	

### **SUBTITLE LANGUAGE**

Following options are available for the SUBTITLE LANGUAGE:

ENGLISH	GERMAN	SPANISH	FRENCH	PORTUGUESE
ITALIAN	RUSSIAN	DUTCH	SWEDISH	KOREAN
DANISH	NORWEGIAN	POLISH	HUNGARIAN	

### **MENU LANGUAGE**

Following options are available for the MENU LANGUAGE:

ENGLISH	GERMAN	SPANISH	FRENCH	PORTUGUESE
ITALIAN	RUSSIAN	DUTCH	SWEDISH	KOREAN
DANISH	NORWEGIAN	POLISH	HUNGARIAN	

### **DIVX LANGUAGE**

Following options are available for the DIVX LANGUAGE:

CENTRAL	EU
WESTERN	EU
KOREAN	

## AUDIO SETUP



### **AUDIO OUT**

Following options are available for the AUDIO OUT:

SPDIF / OFF          SPDIF / RAW          SPDIF / PCM

### **KEY**

Following options are available for the KEY:

b    -4    -2    0    +2    +4    #

## VIDEO SETUP

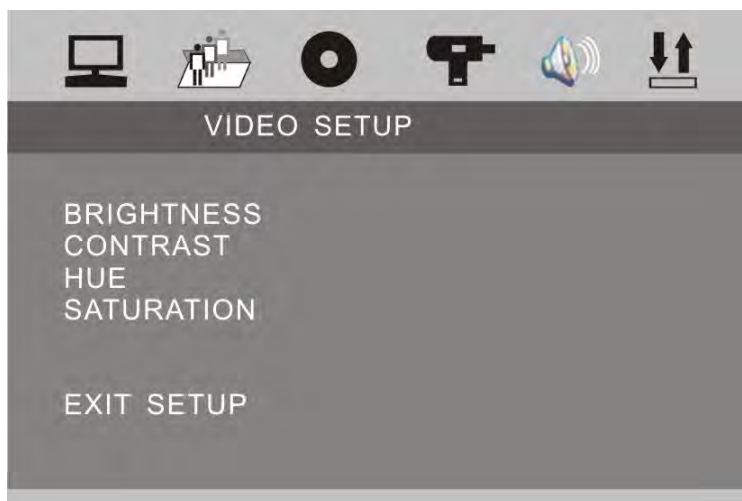

### **BRIGHTNESS**

Following options are available for the BRIGHTNESS:

0    2    4    6    8    10    12

## **CONTRAST**

Following options are available for the CONTRAST:

0 2 4 6 8 10 12

## **HUE**

Following options are available for the HUE:

-6 -4 -2 0 +2 +4 +6

## **SATURATION**

Following options are available for the SATURATION:

0 2 4 6 8 10 12

## **SPEAKER SETUP**

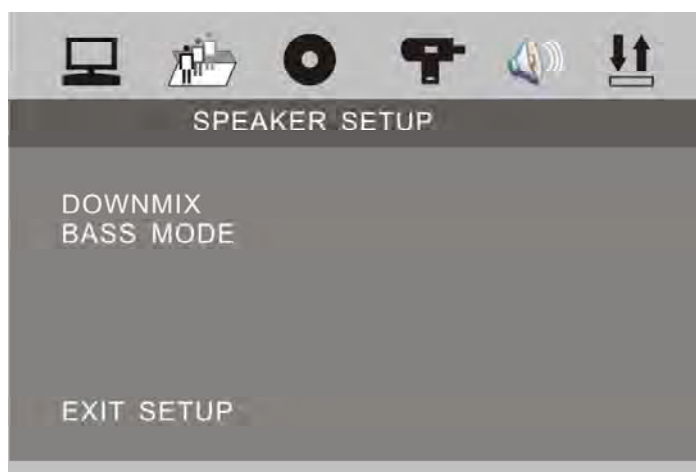

## **DOWNMIX**

Following options are available for the DOWNMIX:

LT / RT                  Stereo                  VSS

## **BASS MODE**

Following options are available for the BASS MODE:

ALL LG SPK                  ALL SM SPK                  MIXED SPK

## **DIGITAL SETUP**

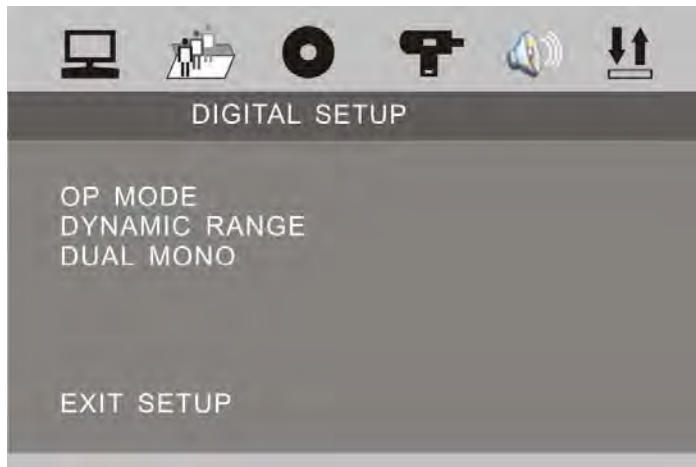

### **OP MODE**

Following options are available for the OP MODE:

LINE OUT                      RF REMOD

### **DYNAMIC RANGE**

Following options are available for the DYNAMIC RANGE:

FULL                      6 / 8                      4 / 8                      2 / 8                      OFF

### **DUAL MONO**

Following options are available for the DUAL MONO:

STEREO                      MONO L                      MONO R                      MIX MONO

## **TROUBLE SHOOTING**

**If any of problem persists after checking the below list, Please consult your nearest service dealer.**

**Never attempt to disassemble and repair unit personally.**

<b>Problem</b>	<b>Cause</b>	<b>Corrective Action</b>
<b>GENERAL</b>		
Unit will not power on	ACC Fuse blown Car battery fuse blown illegal operation	Install new fuse with correct rating Install new fuse with correct rating Press the RESET button located in the bottom right corner of the front panel
Remote control does not	Battery depleted Battery installed incorrectly	Replace battery with new one Remove battery and install correctly
No/low audio output	Improper audio output connection Volume set too low Speakers damaged Heavily biased volume balance Speakers wiring is in contact with metal Part or car	Check wiring and correct Increase volume level Review wiring diagram and check MUTE connection Replace speakers Adjust the channel balance to the center position Insulate all speaker wiring connections
Poor sound quality or distortion	Pirate disc is in use Speaker power rating not compatible with unit Speaker is shorted	Use original copy Connect proper speakers Check speaker contact
Unit resets itself when engine is off	Incorrect connection between ACC and Positive battery wire	Check wiring and correct
<b>TUNER</b>		
Weak station searching	Auto antenna is not fully extended Auto antenna not properly connected LOCAL function is activated	Connect the auto antenna control cable properly Connect the auto antenna control cable properly Turn LOCAL function off

<b>Problem</b>	<b>Cause</b>	<b>Corrective Action</b>
<b>TFT MONITOR</b>		
Monitor does not open automatically	TFT Auto Open is turned of	Turn TFT Auto open on
No image	Incorrect connection to parking brake wire PARKING is activated and parking brake is not engaged	Check wiring and correct Stop vehicle in safe place and apply parking brake
Flashing image or interference appears on screen	DVD is not compatible with current TV system settings Image blurred, distorted, or dark	Change setup to accommodate disc
Prolonged image or improper height/width ratio display	Improper video signal connections Improper aspect ratio setup	Check wiring and correct Use correct aspect ratio setting
Monitor stops at incorrect position	Moving path is blocked	Press OPEN key to restart monitor movement
<b>VCD</b>		
Cannot insert disc	Disc already inside unit	Eject current disc and insert new one
Disc does not play back	Disc is warped or scratched Disc is dirty or wet Incompatible disc is used Disc rating exceeds Parental Lock rating limit Disc region code is not compatible with unit Disc is inserted upside down	Use disc in good condition Clean disc with soft cloth Use compatible disc Change parental Lock settings to lower restriction Use compatible disc Change Parental Lock settings to lower restriction Use disc with proper region cod Insert disc with label side up
Image blurred , distorted, or dark	Disc is illegally copied	Use original disc
PBC cannot be used during VCD playback	PBC is not available on the disc	
No repeat or searching while playing VCD	PBC is on	Turn PBC off

<b>Problem</b>	<b>Cause</b>	<b>Corrective Action</b>
<b>MP3</b>		
Interruption occurred during playback	Disc is dirty or scratched	Clean disc or replace
	File is damaged/bad recording	Recreate disc with good files
Incorrect playback message displayed	Message is longer than LCD can display	

### **Error Messages**

<b>Message Displayed</b>	<b>Cause</b>	<b>Corrective Action</b>
Loading	Disc is being read	
No disc	Disc is dirty	Clean disc with soft cloth
	Disc is upside down	Insert disc with label side up
	Disc not present in loading compartment	Insert disc
Bad Disc	Disc is dirty	Clean disc with soft cloth
	Disc is upside down	Insert disc with label side up
Unknown disc	Disc format is not compatible with this unit	
Region Error	DVD is not compatible with region code of unit	
Error	illegal mechanism operation	Press EJECT key for 5 seconds to reset loading mechanism

## **SPECIFICATIONS**

### **GENERAL**

Supply Voltage	: 14.4 V DC (10.8-16 V DC Allowable)
Load Impedance	: 4 $\Omega$
Max Power Output	: 50 W x 4
Bass 100Hz	: $\geq$ 10dB
Treble 10KHz	: $\geq$ 10dB
Dimension (approx)	: 187 x 188 x 60 mm (d/w/h)
Mounting (approx)	: 160 x 178 x 50 mm (d/w/h)

### **FM TUNER**

Frequency Range	: 87.5-107.9 MHz (USA)
	: 87.5-108.0 MHz (Europe/China)
IF	: 10.7 MHz
Usable Sensitivity	: $\leq$ 15 dB $\mu$ V
Stereo Separation	: $\geq$ 27 dB(1KHz)
Frequency Response	: 20-10000 Hz

### **AM TUNER**

Frequency Range	: 530-1710 KHz (USA)
	: 522-1620 KHz (Europe)
	: 531-1602 KHz (China)
IF	: 450 KHz
Usable Sensitivity	: $\leq$ 34 dB $\mu$ V

### **TV TUNER**

Frequency Range	PAL: 55.25MHz - 855.25MHz
	NTSC: 55.25MHz - 855.25MHz

### **DVD PLAYER**

Signal System	: PAL/NTSC
Signal-to-noise Ratio	: $\geq$ 80 dB(1KHz)
Distortion	: $\leq$ 0.5%

### **MONITOR**

Resolution	: 1440 (w) x 234 (H) (RGB)
Brightness	: 350 cd/m <sup>2</sup>
Contrast	: 300:1

### **NOTE:**

Specifications and design are subject to modification without notice due to improvements in technology.

## DISC NOTES

- Disc formats supported by this player



### Handling and Cleaning

- Dirty, dusty, scratched or warped discs will cause misoperation.
- Do not place stickers or make scratches on discs.
- Do not warp discs.
- A disc should always be kept in its case when not in use to prevent from damage.
- Do not place discs in the following places:
  1. Direct sunlight.
  2. Dirty, dusty and damp areas.
  3. High temperature places.
  4. On the seats or dashboard.

### Disc Cleaning

Use a dry soft cloth to wipe the surface. If the disc is quite dirty, use a soft cloth slightly moist with isopropyl (rubbing) alcohol. Never use solvent such as benzene, thinner or conventional record cleaners which may mar the surface of the disc.

### NOTE:

A disc may become somewhat scratched (although not enough to make it unusable) depending on your handling it in the condition of the usage environment. These scratches are not an indication of any problem with the player.

### Repairing New Discs with Rough Spots

A new disc may have rough edges on its inside and outside edges. If a disc with rough edges is used, the proper setting will not be performed and the player will not play the disc. Therefore, remove the rough edges in advance by using a ballpoint pen or pencil. To remove the rough edges, press the side of the pen or pencil against the inside and outside edges of the disc.

